



PERFORMANCE ELECTRONICS

INSTALLATION AND TUNING GUIDE FOR:

EMS P/N 30-6905

EMS-4 PROGRAMMABLE ENGINE MANAGEMENT SYSTEM

WARNING:



This installation is not for the tuning novice nor the PC illiterate! Use this system with **EXTREME** caution! The EMS-4 allows for total flexibility in engine tuning. Misuse of this product **WILL** destroy your engine!

Installation of the EMS-4 must be performed by a qualified EFI technician familiar with EFI sensors, actuators and wiring.

You should also visit the AEM EMS Tech Forum at <http://www.aempower.com>

NOTE: AEM holds no responsibility for any engine damage that results from the misuse of this product!

This product is legal in California for racing vehicles only and should never be used on public highways.

AEM PERFORMANCE ELECTRONICS
2205 W. 126TH STREET, UNIT A HAWTHORNE CA 90250
PHONE: 310-484-2322 FAX: 310-484-0152
<http://www.aemelectronics.com>

Revision History

Version	Date	Modified Sections	Description
Initial Release, 1.0	12/27/10		
1.1	12/28/10	Typical Idle Setup Tab	Added example calculations for Idle Frequency Settings
		Injectors section	Clarified a section reference
1.2	12/28/10	Injection Phasing	Added details on Injector Advance table
		Coil Phasing	Added details on alternative firing order setups
1.3	12/30/10	EMS-4 GPIOs	Added additional details to example setups
1.4	1/4/11	Timing Pattern Basics	Corrected error in diagram
1.5	1/10/11	Various	Fixed several minor typographical errors
1.6	2/10/11	Internal Logging	Clarifications
1.7	3/23/11	Advanced Tuning	Added Switched Ign Retard/Cut documentation

Table of Contents

General Information	6
Electronics Warranty	6
Part 1 – EMS-4 Installation	7
EMS-4 Basic Specifications	7
Wire Harness Options	7
ECU Terminations with Mini Harness, P/N 30-2905-0.....	10
Electronic Wiring Conventions	16
Grounding	17
Power Requirements of the AEM EMS.....	17
Use of Relays to Control Ancillary Devices	17
Installation with Full Harness, P/N 30-3905-96	18
USB Connector	18
CAN Connector.....	19
Injectors	19
Coils / Electronic Ignition System Basics	21
TPS (Throttle Position Sensor)	26
MAP Sensor.....	26
Air Temp Sensor	27
Water Temp Sensor.....	28
Crank Sensor	29
Cam Sensor	33
Vehicle Speed Sensor (VSS).....	34
Part 2 – AEM Tuner	37
Software Installation	37
AEM Tuner	39
Basic Terminology	40
Menu Items	42
Editing EMS Calibration Files	77
Editing Options Displays.....	77
Editing 2D Table Displays.....	81
Editing Channel Displays.....	89
Editing 3D Map Displays.....	90

Part 3 – Tuning Guide.....	98
Background	98
Fuel Tuning General Concepts.....	98
Spark Tuning General Concepts	99
Calibration Setup.....	100
Base Calibrations.....	100
Timing Pattern Basics.....	101
Fuel Phasing and Injector Setup.....	104
A more complex example	106
Ignition Phasing and Coil Dwell Discussion	107
Set up RPM and Load axes	114
EFI Sensors.....	115
TPS (Throttle Position Sensor)	115
MAP (Manifold Pressure Sensor)	116
Air Temperature Sensor	119
Water Temp Sensor.....	120
O ₂ (Oxygen) Sensors.....	120
Knock Sensor	125
Sensor Calibration	126
Fuel System Setup	134
Fuel Pump Setup	134
Fuel Pump Sizing.....	135
Fuel Pump Location.....	136
Fuel Hoses and Routing	136
Fuel Delivery Hose Sizes.....	137
Fuel Filter and Fuel Rail.....	137
Fuel Pressure Regulator and Pulse Dampener	139
Basic Tuning.....	142
Timing Pickup Confirmation.....	142
Noise.....	145
Ignition Synchronization.....	146
Crank Fuel & Engine Start	148
Idle Air Control	150

Fuel Tuning.....	158
Acceleration/Deceleration Modifiers for Engine Fueling	176
Ignition Tuning Theory	182
Ignition Map	193
Ignition Trims	193
Vehicle Speed.....	197
EMS-4 GPIOs	199
Data logging.....	209
Advanced Tuning	216
Boost Control	216
Knock Control	231
Traction Control	233
2Step Rev Limiter	242
O2 Feedback	245
Nitrous Control.....	252
Anti-Lag	256
Analog Input Switch	259
Staged Injection	260
Switched Ignition Retard/Cut	266
Glossary of Terms	269
Index.....	278

General Information

READ AND UNDERSTAND THESE INSTRUCTIONS BEFORE ATTEMPTING TO INSTALL THIS PRODUCT. VISIT THE AEM PERFORMANCE ELECTRONICS TECH SUPPORT FORUM AT <http://forum.aempower.com/forum/index.php> ALL CURRENT SOFTWARE AND DOCUMENTATION IS AVAILABLE ON THIS FORUM.

YOU MAY ALSO CONTACT AEM PERFORMANCE ELECTRONICS TECH SUPPORT AT 1-800-423-0046 IF YOU HAVE ANY QUESTIONS.

Electronics Warranty

Advanced Engine Management Inc. warrants to the consumer that all AEM Electronics products will be free from defects in material and workmanship for a period of twelve months from date of the original purchase. Products that fail within this 12-month warranty period will be repaired or replaced when determined by AEM that the product failed due to defects in material or workmanship. This warranty is limited to the repair or replacement of the AEM part. In no event shall this warranty exceed the original purchase price of the AEM part nor shall AEM be responsible for special, incidental or consequential damages or cost incurred due to the failure of this product. Warranty claims to AEM must be transportation prepaid and accompanied with dated proof of purchase. This warranty applies only to the original purchaser of product and is non-transferable. All implied warranties shall be limited in duration to the said 12-month warranty period. Improper use or installation, accident, abuse, unauthorized repairs or alterations voids this warranty. AEM disclaims any liability for consequential damages due to breach of any written or implied warranty on all products manufactured by AEM. Warranty returns will only be accepted by AEM when accompanied by a valid Return Merchandise Authorization (RMA) number. Product must be received by AEM within 30 days of the date the RMA is issued.

Please note that before AEM can issue an RMA for any electronic product, it is first necessary for the installer or end user to contact the tech line at 1-800-423-0046 to discuss the problem. Most issues can be resolved over the phone. Under no circumstances should a system be returned or a RMA requested before the above process transpires.

AEM will not be responsible for electronic products that are installed incorrectly, installed in a non-approved application, misused, or tampered with.

Any AEM electronics product can be returned for repair if it is out of the warranty period. There is a minimum charge of \$50.00 for inspection and diagnosis of AEM electronic parts. Parts used in the repair of AEM electronic components will be extra. AEM will provide an estimate of repairs and receive written or electronic authorization before repairs are made to the product.

Part 1 – EMS-4 Installation

EMS-4 Basic Specifications

EMS-4 Specifications

CPU Core:	16 bit / 40 MHz
Injector Drivers:	4 x Saturated (8 ohm minimum, High Impedance Only)
Coil Drivers:	4 x 0-5V Falling Edge Fire (do not connect directly to coil primary)
GPIO Pins:	4 x 1.5A Low Side Output / 0-5V Analog Input / Switch Input 4 x 1.5A Low Side Output / 0-5V Analog Input / PWM output
O2 Sensor Input:	1 x 0-5V analog
Timing Sensor Inputs:	1 x VR (mag) Cam Input 1 x VR (mag) Crank Input 1 x Hall VSS Input 1 x Hall Crank Input 1 x Hall Cam Input
Knock Sensor Input	1x Programmable
Throttle Position Input	1 x 0-5V
Manifold Pressure Sensor	1 x 0-5V
Coolant Temperature Sensor	1 x analog
Inlet Air Temperature Sensor	1 x analog
USB	1 x EMS / PC Communication
CAN	1 x Programmable Send / Receive
Sensor Ground	1 x
5 Volt Reference	1 x

Wire Harness Options



EMS-4 with 30-2905-96 Full Harness



EMS-4 with 30-2905-0 Mini Harness

AEM 30-2905-0 HARNESS

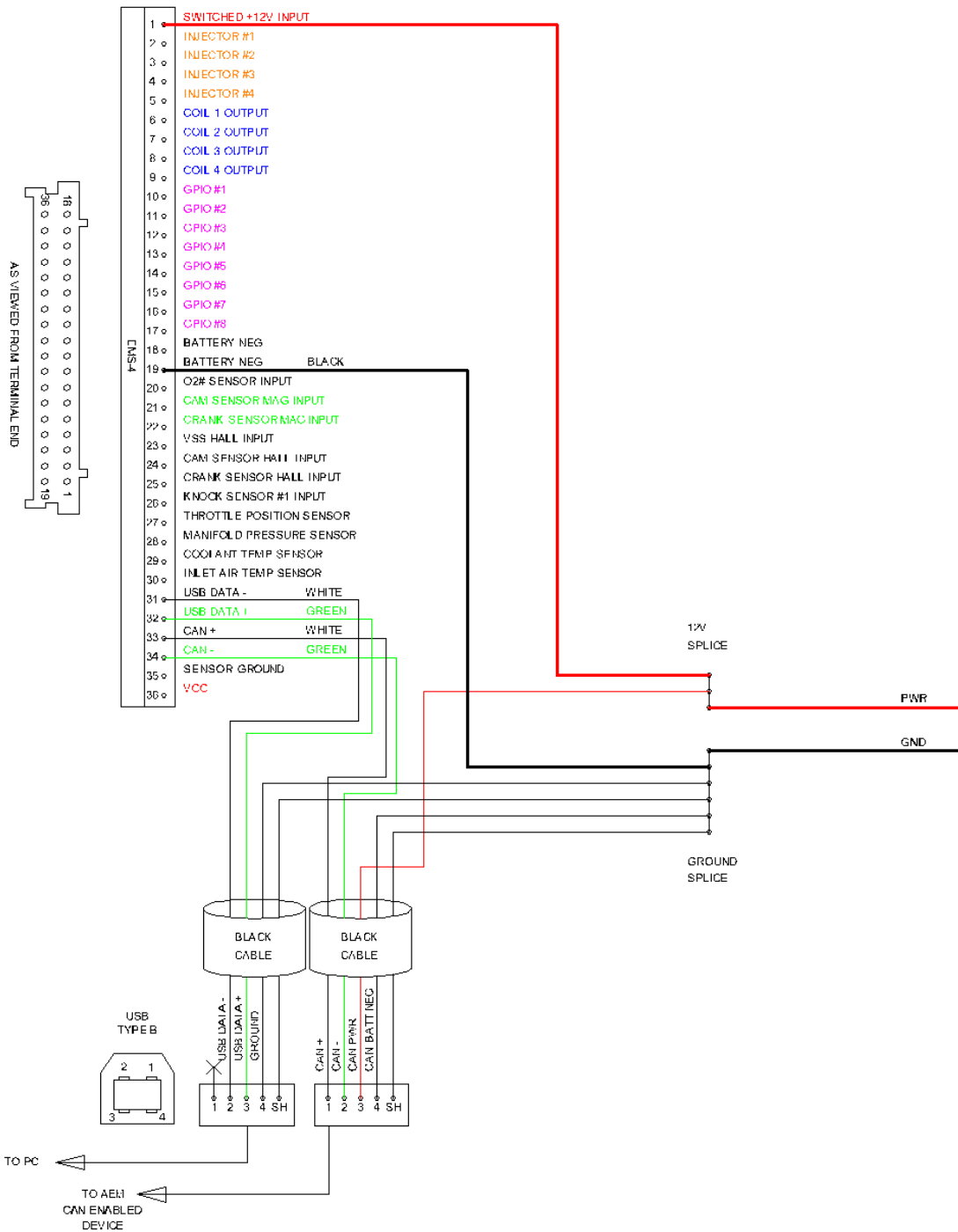

<p>UNLESS OTHERWISE SPECIFIED DIMENSIONS ARE IN INCHES TOLERANCES ARE: FRACTIONS DECIMALS ANGLES $\pm 1/16"$ $.XX \pm 0.01$ $\pm 1^\circ$ $.XXX \pm 0.005$</p>	CAD GENERATED DRAWING, DO NOT MANUALLY UPDATE								
	APPROVALS	DATE		<p>30-3905-0 EMS-4 MINI HARNESS</p>					
DRAWN SCA	12/1/10								
CHECKED	--								
RESP ENG	--								
MFC ENG	--								
DO NOT SCALE DRAWING	QUAL ENG	--	<table border="1" style="width: 100%; border-collapse: collapse;"> <tr> <td style="width: 50%;">SIZE DWG. NO. A</td> <td style="width: 50%;">REV. A</td> </tr> <tr> <td colspan="2">SCALE: NONE CAD FILE:</td> </tr> <tr> <td colspan="2" style="text-align: right;">SHEET 1 OF 1</td> </tr> </table>	SIZE DWG. NO. A	REV. A	SCALE: NONE CAD FILE:		SHEET 1 OF 1	
SIZE DWG. NO. A	REV. A								
SCALE: NONE CAD FILE:									
SHEET 1 OF 1									

AS VIEWED FROM TERMINAL END

- 1 SWITCHED +12V INPUT RED
- 2 INJECTOR #1 ORANGE
- 3 INJECTOR #2 ORANGE
- 4 INJECTOR #3 ORANGE
- 5 INJECTOR #4 ORANGE
- 6 COIL 1 OUTPUT DK BLUE
- 7 COIL 2 OUTPUT DK BLUE
- 8 COIL 3 OUTPUT DK BLUE
- 9 COIL 4 OUTPUT DK BL UF
- 10 GPIO #1 PINK
- 11 GPIO #2 PINK
- 12 GPIO #3 PINK
- 13 GPIO #4 PINK
- 14 GPIO #5 PINK
- 15 GPIO #6 PINK
- 16 GPIO #7 PINK
- 17 GPIO #8 PINK
- 18 BATTERY NEG BLACK
- 19 BATTERY NEG BLACK
- 20 O2# SENSOR INPUT WHITE
- 21 CAM SENSOR MAG INPUT GREEN
- 22 CRANK SENSOR MAG INPUT GREEN
- 23 VSS HALL INPUT WHITE
- 24 CAM SENSOR HALL INPUT BLACK
- 25 CRANK SENSOR HALL INPUT BLACK
- 26 KNOCK SENSOR #1 INPUT WHITE
- 27 THROTTLE POSITION SENSOR WHITE
- 28 MANIFOLD PRESSURE SENSOR WHITE
- 29 COOLANT TEMP SENSOR WHITE
- 30 INLET AIR TEMP SENSOR WHITE
- 31 USB DATA - WHITE
- 32 USB DA1A+ GREEN
- 33 CAN + WHITE
- 34 CAN - GREEN
- 35 SENSOR GROUND BLACK
- 36 VCC RED

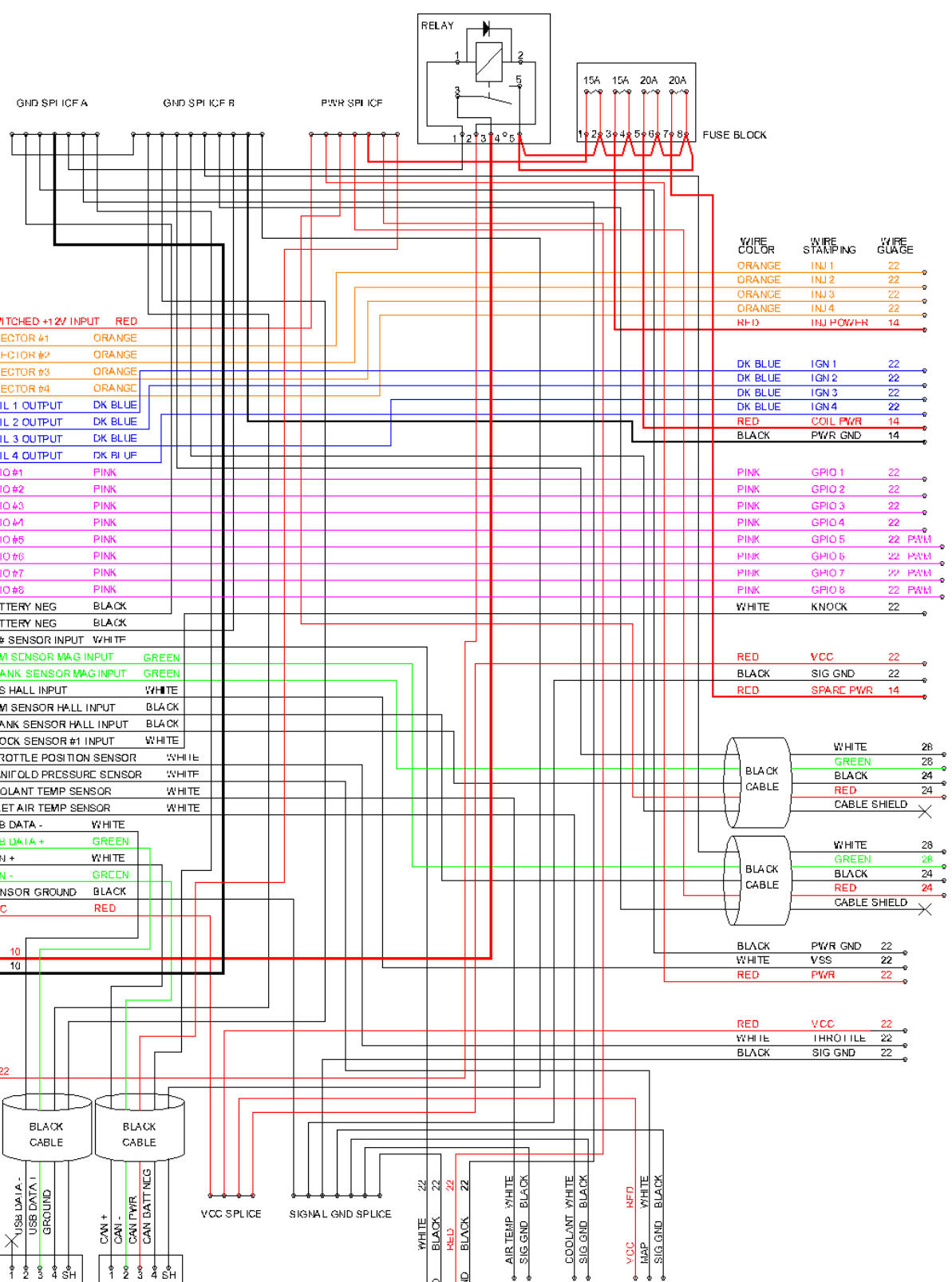

RED BATT POS 10
BLACK BATT NEG 10

RED IGN SWT 22

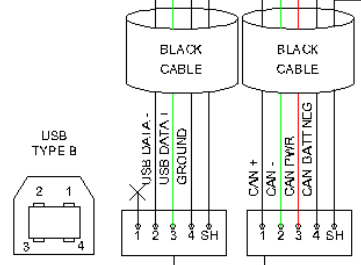

IO PC
TO AEM CAN ENABLED DEVICE

UNLESS OTHERWISE SPECIFIED DIMENSIONS ARE IN INCHES		DO NOT SCALE DRAWINGS	
DATE	REV	DESCRIPTION	BY
1.5.10	XX	1.001	1.1
INTERNAL		DESIGNED BY	...
PART		DATE	...
Dwg No: 30-3805-46		Rev: 1.1	...

AEM PERFORMANCE ELECTRONICS

30-3805-46
EMS-4 FULL HARNESS

SCALE	1:1
UNIT	INCHES
DATE	...
BY	...
CHECKED	...

Two partially assembled harness options are available for the EMS-4:

1. P/N 30-2905-96 EMS-4 Full Harness
2. P/N 30-2905-0 EMS-4 Mini Harness

Photographs and schematics for each are shown above. The Full Harness option is best suited to applications where no factory harness exists or where modifications are so extensive, it is easier to build a custom harness. This harness includes a fused power distribution center with main relay. All circuits are pre-terminated at the ECU connector. All sensor input and actuator output leads are grouped and clearly labeled. All power and ground splices are pre-configured. All sensitive communications and CAN data stream circuits are pre-configured.

The Mini Harness option is best suited to applications where the factory harness is suitable as a starting point for modifications. Like the fully populated harness, the mini version includes pre-terminated CAN data stream and communications circuits. It also includes primary power and ground inputs. This is the minimum required for powering up the EMS and enabling communications. All other harness terminations are the responsibility of the installer. A bag of Delphi/Packard female terminals is included for terminating all circuits at the main ECU connector.

Installers choosing the Mini Harness option should refer to the Full Harness schematic above and the EMS-4 System Diagram that shows an example of a complete system design.

ECU Terminations with Mini Harness, P/N 30-2905-0

The following steps illustrate how to open the ECU connector backshell so additional circuits can be added.

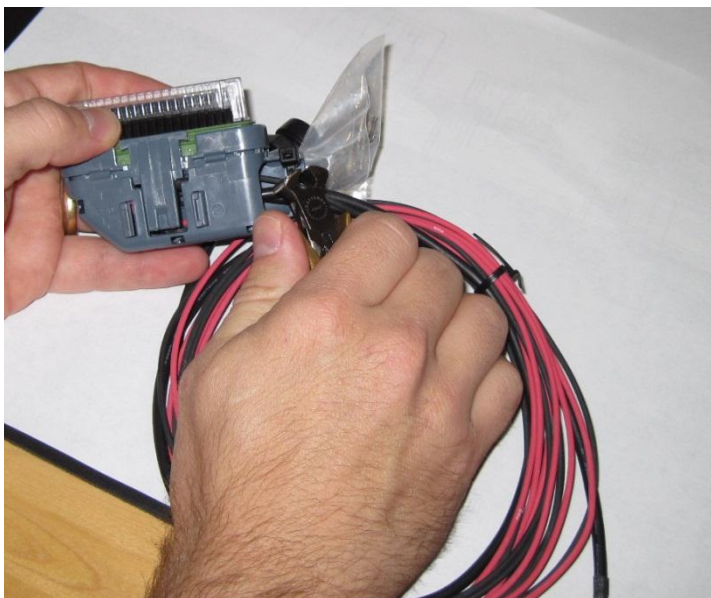

Begin by cutting the strain relief tie wrap holding the terminal bag as shown.

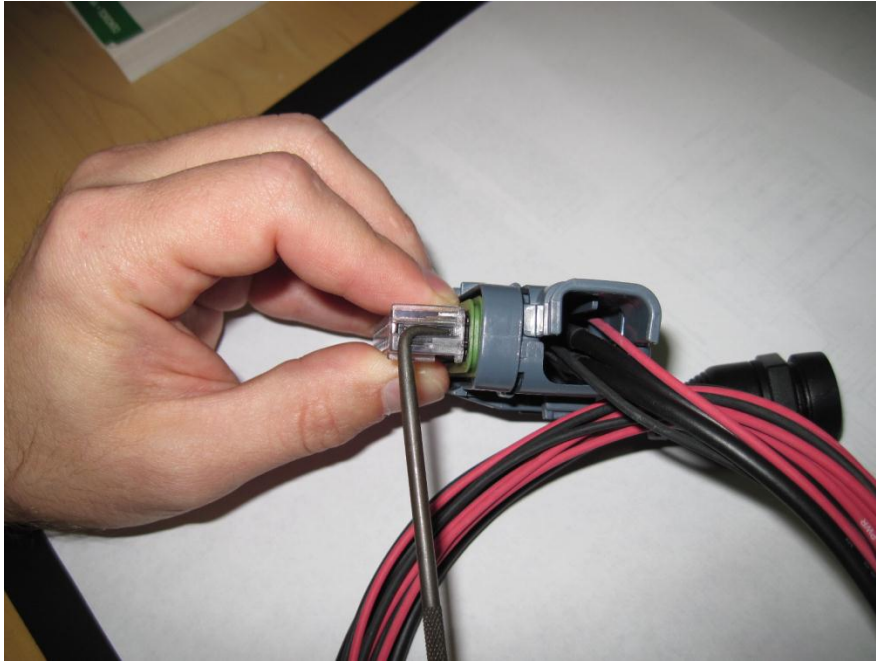

Using a sharp pick or probe, push in on the locking tabs holding the outer retainer.

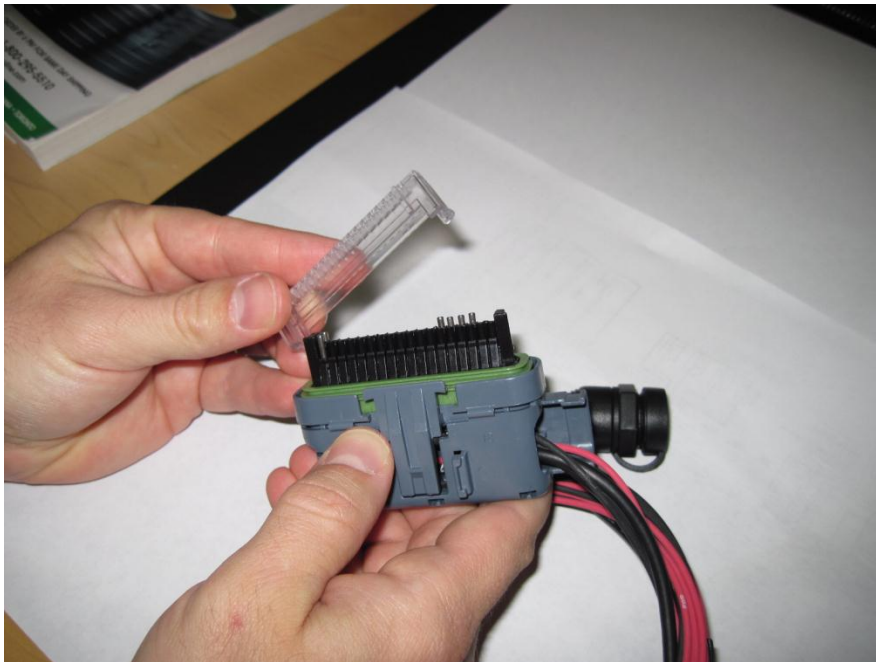

Remove the retainer.

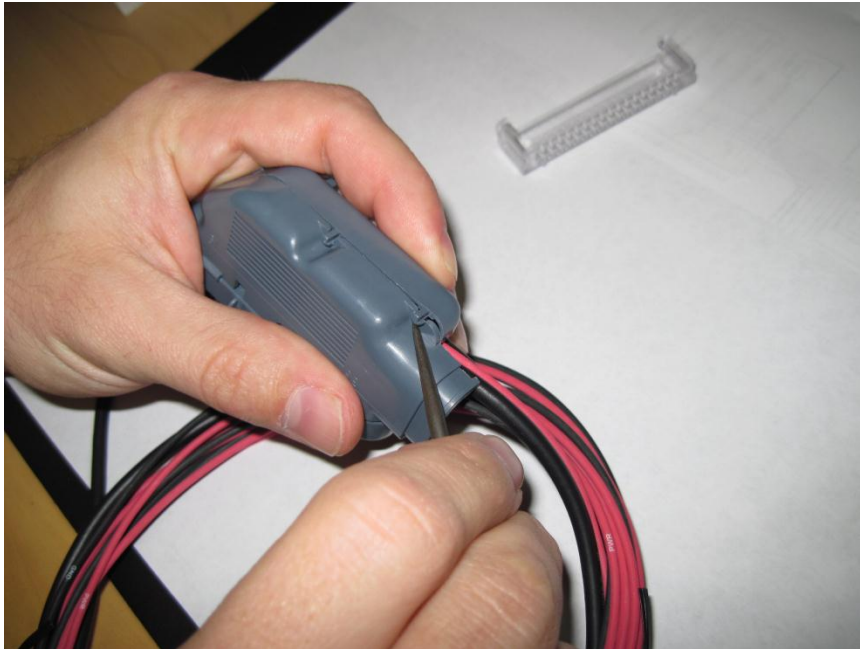

Use pick to pry open the retaining tabs holding the backshell halves together.

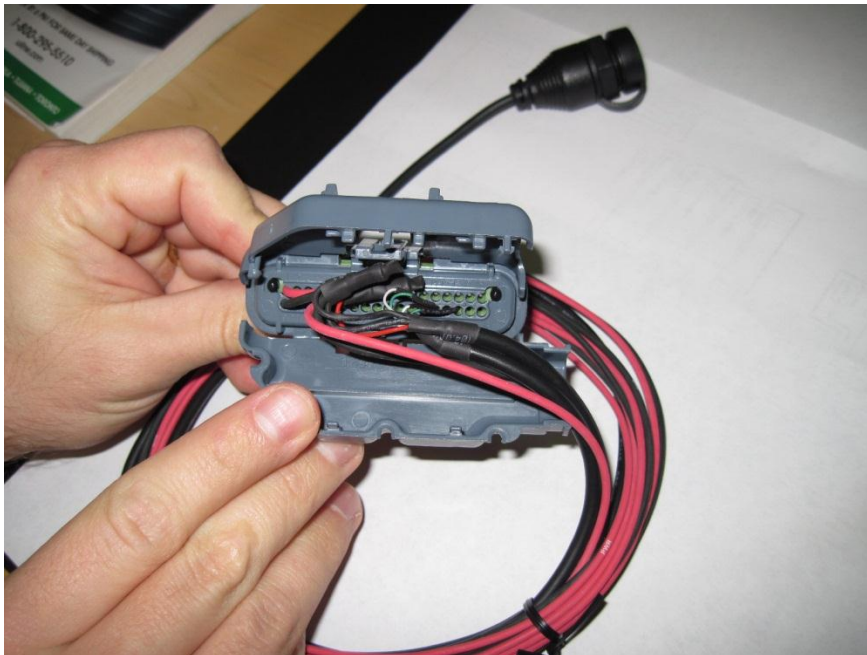

Open the shell to expose the cavities.



To remove a terminal, carefully pry up on the retaining clip. Be careful as the clips can break if bent too far.

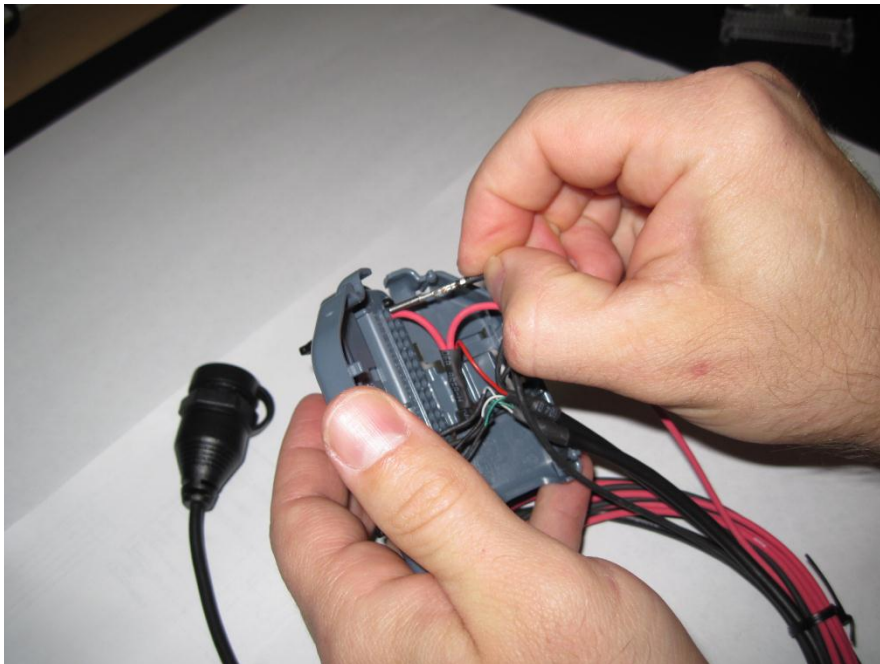

To add a new circuit, insert the terminal from the back as shown until it clicks into place.



Showing terminal fully seated.

Following is the proper tool for use with the Delphi Micro Pack terminals used in the ECU main connector.

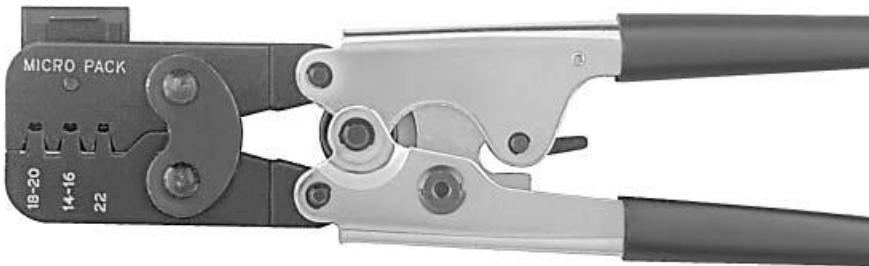

Delphi Part No: 12070948

Application: Unsealed Micro-Pack 100, Female only

Core and Insulation

Cable Range (mm²): 2.0-0.35

The tool is available in many places. One is shown below. Web address – <http://www.mouser.com> AEM recommends using the proper tool for all ECU terminations.

The screenshot shows the Mouser Electronics website interface. At the top, there is a navigation bar with the Mouser Electronics logo (a tti company), contact information (817) 804-3888, and links for Contact Us, Feedback, View Cart, and Change Country. Below this is a search bar with the text "Part # / Keyword (English Only)" and a "Search" button. Navigation tabs include Products, Suppliers, Catalog, Project Manager, EZ Buy, Order History, and Help. Language and currency are set to English and USD.

The main content area is titled "Product Detail" and shows the breadcrumb path: "All Products » Interconnects » Automotive Connector Accessories » 12070948". The product image shows a hand crimper tool. Key details include:

- Mouser Part #:** 829-12070948
- Manufacturer Part #:** 12070948
- Manufacturer:** Delphi Connection Systems
- Description:** Automotive Connector Accessories HAND CRIMPER

Additional information includes a "Data Sheet" link, a "Larger Image" link, and a note: "Images are for reference only See Product Specifications".

On the right side, there is an "Availability" section with the following information:

- Stock:** 2 Can Ship Immediately
- On Order:** 0
- Factory Lead-Time:** 8 Weeks

Below this is a "Buy" button with a quantity input field. The "Enter Quantity" section shows a minimum of 1 and multiples of 1.

The "Pricing (USD)" section shows:

- 1: \$145.92
- 25: \$134.69

There is a "Get Quote" link for more information.

At the bottom of the page, there is a "Specifications" section with tabs for "Specifications", "Documents", and "My Notes". The specifications table is as follows:

Manufacturer:	Delphi Connection Systems	<input checked="" type="checkbox"/>
Product Category:	Automotive Connector Accessories	<input checked="" type="checkbox"/>
RoHS:	Not Applicable	
Product:	Application Tooling Hand Crimper	<input checked="" type="checkbox"/>
Packaging:	Bulk	

Below the table are buttons for "Add to Compare List" and "Show Similar". A note states: "Show Stocked Products With Similar Attributes. Found: 3". A checkbox is checked, and the text reads: "Show stocked product(s), check and uncheck the boxes above. Per above selection(s)".



Image shows a properly crimped terminal. Top View.



Side View. After crimping, be sure to do a pull test to make sure the terminal is properly installed.

Electronic Wiring Conventions

A proper wiring job includes proper termination of the wire at the sensor. The wire terminal end must be moisture tight where it plugs into the sensor and it must have strong, electrically sound terminals. The preferred method of securing a wire to a terminal is to use a crimp terminal with NO solder. It is important to use the proper crimping tool for sound terminal construction. Plastic terminal plugs must have moisture tight seals. Inspect each plug to make sure the seals are in place. Also, before the plug is installed on the sensor, apply a dab of di-electric grease in the terminal slots to further aid in corrosion resistance.

If a splice into a wire must be made and no solder-less terminals are available, then you must properly solder the splice.

Noise can be a serious problem and can cause intermittent misfiring of the engine. Every precaution should be taken to prevent interference to the ECU's operation. Resistive plug leads are REQUIRED, and shielded cables from the crank and cam angle sensor inputs are highly recommended. All racing AEM EMS wire harnesses come with properly shielded cables and are color coded for easy identification of circuits. They are also shrink wrapped for abrasion protection. The crank and cam angle sensor wire has a bare wire running down the length of it. It is **NOT** terminated at the sensor end of the cable because we ground it at the plug end of the harness. **DO NOT GROUND THIS WIRE!** This will cause a condition called ground looping and will remove any noise protection the cable has.

To eliminate or reduce the chance of EMI, wires that carry high current must run in twisted pairs. An example of this would be the power leads from a multiple spark ignition system. These ignition systems can carry up to 100 amps for a couple milliseconds at the time of discharge, which induces a strong magnetic field in close proximity of the wires.

The routing of the wire loom is critical to EFI system performance and safety. The following safety considerations should be made when installing the wire loom:

- Heat protection: the loom should be placed away from or insulated from sources of heat. The obvious item(s) that should be avoided are the exhaust manifolds, EGR delivery tubes, and turbochargers. If it is absolutely necessary to route a wire in close proximity to any of these items, then a suitable insulator must be used.
- Noise suppression: do not route wires near the HT leads. For coil- on-plug ignition systems this is not as critical.
- Moving component protection: route wires away from moving components such as fans, the blower belt, or the throttle linkage. Also, make sure the wires are not under any strain when the engine is at full deflection on the motor mounts (we have seen map sensor wires disconnect while under full acceleration because the motor mounts were bad).
- Never have the wires in exposed bundles throughout the engine compartment. A professional harness has shrink tube over it to resist abrasion and chemical damage to the wire loom.

Grounding

The ECU must have an electrically secure ground connection, which means that the battery negative must be properly grounded to the chassis AND engine. The ground wire, whether it is from the battery or to the chassis and engine, must have perfect electrical conductivity. This means that there must not be any paint or rust under the wire terminal. Make sure that when you install the ground wire there is bare metal exposed where the wire contacts the vehicle component. To prevent rust build up, we recommend applying a protective layer of dielectric grease, such as Standard Ignition SL-4, to the bare metal surface. The ground wire must be **at least** the same gauge as the power lead to the ECU. We also recommend that the ground wire be as short as possible.

Power Requirements of the AEM EMS

The AEM EMS requires a minimum supply voltage of 10V or greater to run. We recommend that the ECU be supplied with 13.8V nominal operating voltage. Ensure that the vehicle's charging system is in perfect operating condition prior to installing the AEM EMS.

Use of Relays to Control Ancillary Devices

Relays are remote switching devices that are used to isolate a device from the ECU's circuitry to reduce noise and power constraints on the ECU. Typical devices that are powered by a relay are:

- Fuel Pump
- Variable Valve Control
- Oxygen Sensor Heater
- ECU power
- Nitrous Oxide solenoids

Noise can be caused by the electric motor in a fuel pump, which if connected directly to the ECU, may feed back into the circuit board ground plane. In the case of a fuel pump, the typical amperage required to run the pump is 10A or more depending on its size. The driver in the ECU that sends the command to run the fuel pump is only capable of supplying 1.5A, and clearly this type of load on the driver would cause it to burn out. There are drivers that can handle larger currents but cost, size, heat dissipation, and noise problems prevent their use.

- Typical relays in use today are capable of carrying 40A. A relay has an electromagnet inside it that is used as a switch. This electromagnet, or switch, is used to position a contact within the relay that is capable of carrying high current. There are typically four or five terminals on the base of a relay. These terminals can be wired in several ways to achieve different results. Refer to the **EMS-4 System Schematic** for common wiring schemes used with relays.

Installation with Full Harness, P/N 30-3905-96

For the following section, please refer to the EMS-4 System Diagram for more information. It shows a schematic representation of a properly designed system using the fully populated harness.

NOTE: The columns in the connection tables below labeled “WIRE” refer to the wire gauge recommended for the harness.

USB Connector



USB Connector

A high quality over-molded termination is included for USB communications. Plug one end of a standard USB extension cable (included) into the harness connector and the other end into an open USB port on the PC. Communications is possible only when the EMS is powered up.

CAN Connector

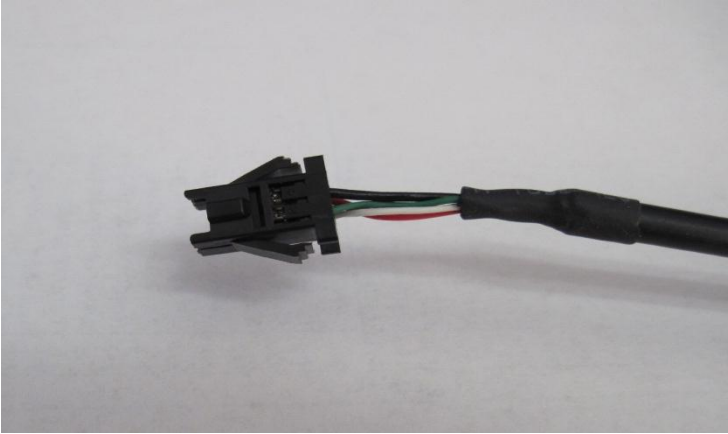

CAN Connector

A compact pre-terminated connector is included for use with AEM CAN enabled devices.

Injectors

Injector Basics

A fuel injector is a valve that can be opened and closed very quickly. To open the valve, current must flow through a solenoid contained in the upper part of the injector assembly. The EMS-4 triggers the injector by providing a ground path to the negative terminal. Fused power is provided to the other terminal from the harness.

WARNING! – The EMS-4 is compatible with high impedance injectors only. For direct drive operation, injector coil resistance must be greater than 8 ohms. Low impedance injectors can be used if a suitable ballast resistor box or Peak and Hold Driver module is used such as AEM P/N 30-2710.

To determine the size of the injectors, the total engine power must be estimated or known. The fuel pump calculations and BSFC information mentioned in the Fuel Pump Sizing section on page 135 provides a good understanding of the fuel requirements for an engine. The following equation will allow you to determine the requirements of your injectors:

$$((\text{Power} \times \text{BSFC}) \times (1 + \text{Safety Margin}))/\text{Number of Injectors} = \text{pounds/hour}$$

An example of this equation is:

6 CYL. engine rated at 500 hp on gasoline using moderate boost with a 15% safety margin on the injector

$$500 \times .625 = 313 \text{ lbs}/6 = 52 \text{ lbs/hr/ injector. } 52 \times 1.15 = 60 \text{ lbs/hr/ injector}$$

If we take the flow of the injector (60 lbs/hr) and multiply it by the number of cylinders (6), we arrive at a total of 360 lbs/hr of flow. As you can see, the fuel pump described in the fuel pump sizing section referenced above has enough capacity to feed the engine with a little room to spare.

It is a good idea to know the maximum operating pressure of the fuel injectors. In some cases the fuel injector will not open if the fuel pressure exceeds the design limit of the injector. Also, at the higher pressures the injector fuel flow may become non-linear and cause inconsistent fuel delivery, usually creating a lean condition. Most injectors can withstand up to 70 psi. Many of the pintle style injectors can withstand higher pressure.

In the fuel injector sizing, always use a safety margin between 15-20%.

Harness Connections

Injector Harness Connections

Name	Wire	Wire Color	Stamping
Injector #1	22	Orange	INJ 1
Injector #2	22	Orange	INJ 2
Injector #3	22	Orange	INJ 3
Injector #4	22	Orange	INJ 4
Fused Injector Power	14	Red	INJ POWER

INJ1 – Connect to 1st injector to fire.

INJ2 – Connect to 2nd injector to fire.

INJ3 – Connect to 3rd injector to fire.

INJ4 – Connect to 4th injector to fire.

INJ POWER – Fused injector power. Splice required number of power leads and distribute to each injector.

AEM kit P/N **30-2020 (Optional)** Bosch Style Injector Connector Kit contains the parts to assemble 4 injector connectors. The kit contains Four Bosch style female injector connectors and 10 contacts (2 extra contacts are included for spares).

IMPORTANT!

The contacts are “Pull to Seat” meaning you must feed the wire through the connector housing BEFORE you crimp on the contacts. The wire is then pulled back into the housing and the contact locks in place. The contact cannot be inserted or removed from the rear (wire side entry) of the housing.

Contacts (10 Included)

Plating	Tin Plated
Cable Range	1.00 - 0.05 mm ²
Outside Cable Diameter	2.40 - 2.03 mm ²
Temperature Range	-40 to 125 C
Resistance in mOhms at 20 mV	> 10.0 Ohms
Voltage Drop in mV per amp	> 3.0 Ohms

Housing (4 Included)

Color	Black
Cavities or Contacts	2
Gender	Female
Temperature Range	-40 to 125 C
Resistance at 20 mV	> 10.0 mOhm
Voltage Drop per amp	> 3.0 mV
Exterior Dimensions	27.8L X 29.6W X 20H
Seating Process	Pull To Seat

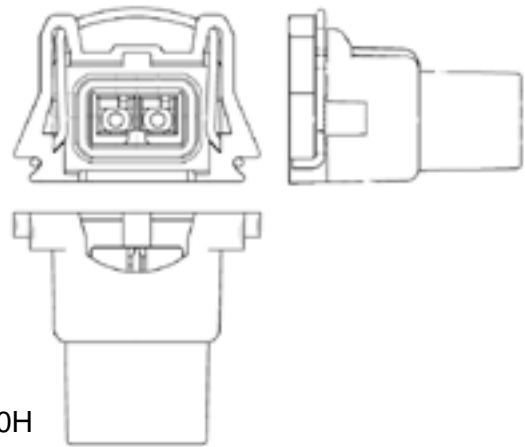

Coils / Electronic Ignition System Basics

An ignition coil is charged when current flows through the primary side of the coil. A coil driver is required to sink the current and dissipate the heat generated during operation. The coil outputs from the EMS-4 are used to trigger the drivers. The drivers can either be contained within the coils themselves or they can be contained within a stand-alone device installed between the EMS-4 and the coils.

There are several different types of ignition systems in use on modern cars. They are:

- Distributed spark using a single coil and a distributor for all cylinders.
- Wasted spark using one coil for two cylinders.
- Direct Fire using one coil on plug of each cylinder.

Distributed Spark

Distributed spark systems have been around the longest. As the name implies, the spark is distributed to the plugs via a coil output to a rotor, then through the distributor cap to the appropriate plug via a high-tension (HT) lead. This is the most complex system because of the relationship that has to be maintained between the firing point, rotor to cap terminal angle, and

engine position. Distributed spark systems also rely on a mechanical link between the engine and ignition output, which adds another dimension of unreliability-and to a minor extent-inaccuracy in timing. In addition to these problems, distributed spark systems typically produce the least intense spark of all ignition systems. The time to achieve full charge diminishes as engine speed increases; therefore the coil charge is reduced as a function of RPM. In spite of the potential problems with distributed spark systems, they have been used successfully for many years on high-performance engines. Distributed spark ignition systems respond well to spark amplification within their design limits.

Wasted Spark

Wasted spark systems employ one coil for two cylinders. The term “wasted spark” comes from the fact that each plug fires every engine revolution. On a 4-cycle engine, the piston is at Top Dead Center (TDC) two times for every cycle; once for firing and again during the overlap phase. The wasted spark coil fires one plug Before Top Dead center (BTDC) and another plug just before the overlap phase (at the latest part of the exhaust stroke before the exhaust valve closes). Wasted spark systems have a higher potential for spark intensity because the duty of charging and discharging is split between the coils, which allows for more charge time per coil. Additionally, wasted spark systems build up less heat in the coil, making it more reliable. Wasted spark systems have been in use since the mid 80’s on GM cars and on motorcycles for considerably longer than that. There are no moving parts, no complicated relationships with a cap and rotor to maintain, and they deliver very accurate spark timing. Furthermore, multi-channel spark amplification systems to enhance spark duration or intensity are available for wasted spark ignition systems.

Direct Fire

Direct fire systems employ one coil on each spark plug and is the most reliable system used today, (this type of system is used on most modern cars). Each coil fires sequentially in the cylinder firing order. The charge time for each coil is twice as long as those of a wasted spark system, which allows direct-fire, coil manufacturers to build compact, lightweight coils that retain sufficient spark energy. There are no moving parts to wear out and no HT leads that will deteriorate. The lack of HT leads in direct fire systems is a major advantage for an EFI-equipped car because there is a very low incidence of noise due to leaking or improperly routed wires. There have been incidences of the terminal from a direct-fire coil (that attaches to the spark plug) cracking and subsequently causing Radio Frequency Interference (RFI) or “noise” to the ECU. This will cause engine operation problems, but it should be noted that these cases are extremely rare.

Harness Connections

Coil Harness Connections

Name	Wire	Wire Color	Stamping
Coil 1 Output	22	Dk Blue	IGN 1
Coil 2 Output	22	Dk Blue	IGN 2

Coil 3 Output	22	Dk Blue	IGN 3
Coil 4 Output	22	Dk Blue	IGN 4
Fused Coil Power	14	Red	COIL PWR
Coil Ground	14	Black	PWR GND

Warning! - The ignition outputs from the EMS-4 are not designed to trigger an ignition coil directly. Connecting them to a coil that does not contain a built-in driver will damage the EMS-4. Coils without built-in drivers typically have only two pins on the connector. Coils with built-in drivers typically have 4 or more pins on the connector. If you are not sure what kind of ignition coils you have, contact AEM tech support for help.

IGN 1 – Connect to 1st coil driver to fire.

IGN 2 – Connect to 2nd coil driver to fire.

IGN 3 – Connect to 3rd coil driver to fire.

IGN 4 – Connect to 4th coil driver to fire.

COIL PWR – Fused coil power. Splice required number of power leads and distribute to each coil.

PWR GND – Ignition power ground.

AEM Kit P/N **30-2840 (Optional)** Four Channel Coil Driver is custom manufactured to AEM's specifications by HÜCO Electronic GmbH in their ISO 9001 facility in Germany. It has been specially designed by AEM for driving the high power dwell controlled ignition coils commonly found on performance engines.

The 30-2840 Kit contains:

- Four Channel Coil Driver
- Five Pin Mating Connector
- Four Pin Mating Connector
- 10 Terminals & Wire seals (one extra of each as a precaution)
- Mounting hardware
- Thermal Grease
-

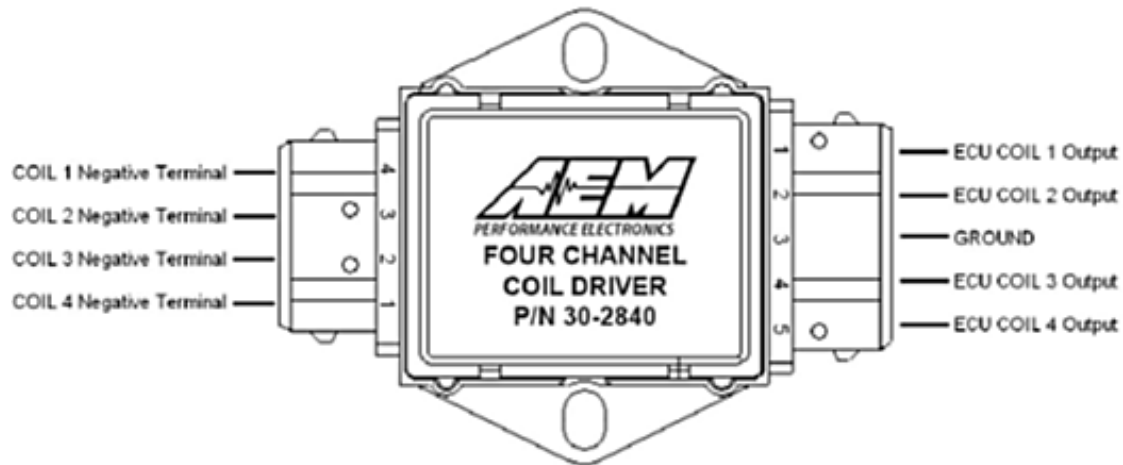

AEM Four Channel Coil Driver P/N 30-2840

Four Channel Coil Driver Connections

Coil Driver Connections

Coil Driver	Connect to
ECU Coil 1 Output	EMS-4 harness, IGN 1
ECU Coil 2 Output	EMS-4 harness, IGN 2
ECU Coil 3 Output	EMS-4 harness, IGN 3
ECU Coil 4 Output	EMS-4 harness, IGN 4
Ground	EMS-4 harness, PWR GND
Coil 1 Negative Terminal	Coil 1 Negative Terminal
Coil 2 Negative Terminal	Coil 2 Negative Terminal
Coil 3 Negative Terminal	Coil 3 Negative Terminal
Coil 4 Negative Terminal	Coil 4 Negative Terminal

CDI Installations

The ignition outputs from the EMS-4 are considered a falling edge fire signal where signal high is dwell time. A coil driver will invert the signal from the EMS-4 pulling the signal low (ground) and allowing current to flow through the coil primary windings. Some CDI ignition boxes are only capable of triggering on the “rising edge” or “Points Trigger” signal. These systems will still require an in-line coil driver to invert the ignition output to fire on the correct edge. The AEM Twin Fire CDI system P/N 2820 (8 channel) and 2821 (4 channel) can be configured to fire on either a rising or falling edge. Applications using an AEM Twin Fire will not require an in-line coil driver. Contact your CDI manufacturer for more information.

IGNITION OUTPUT FROM EMS TO COIL DRIVER OR CDI

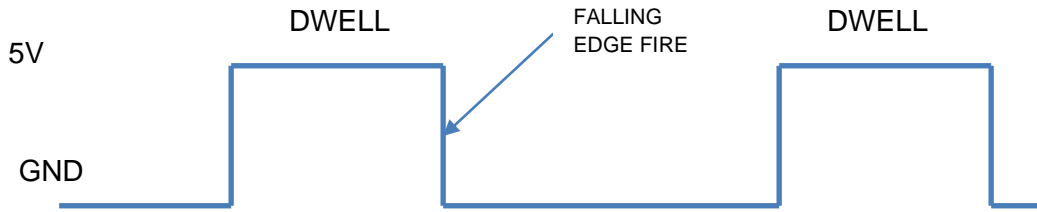

IGNITION OUTPUT AFTER COIL DRIVER

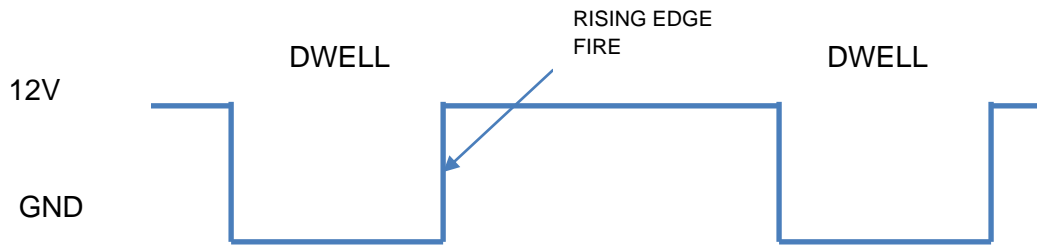

Signal comparison – before and after coil driver

TPS (Throttle Position Sensor)

Harness Connections

TPS Harness Connections

Name	Wire	Wire Color	Stamping
+5.0 volts, Vcc	22	Red	VCC
Throttle Position Sensor	22	White	THROTTLE
Sensor Ground	22	Black	SIG GND

VCC – Connect to sensor 5 volt reference

THROTTLE – Connect to sensor signal

SIG GND – Connect to sensor ground

MAP Sensor

Harness Connections

MAP sensor harness connections

Name	Wire	Wire Color	Stamping
+5.0 volts, Vcc	22	Red	VCC
Manifold Pressure Sensor	22	White	MAP
Sensor Ground	22	Black	SIG GND

VCC – Connect to sensor 5 volt reference

MAP – Connect to sensor signal

SIG GND – Connect to sensor ground

Optional AEM MAP Sensor Listing:

AEM P/N 30-2130-30 “MAP Sensor Kit, 2 BAR”

Typically used to measure intake, air box and crankcase pressures.

AEM P/N 30-2130-50 “MAP Sensor Kit, 3.5 BAR”

Typically used to measure intake & exhaust back pressures.

AEM P/N 30-2130-75 “MAP Sensor Kit, 5 BAR”

Typically used to measure intake & exhaust back pressures.

Air Temp Sensor

Harness Connections

Air Temperature Sensor Harness Connections

Name	Wire	Wire Color	Stamping
Inlet Air Temp Sensor	22	White	AIR TEMP
Sensor Ground	22	Black	SIG GND

AIR TEMP – Connect to sensor signal

SIG GND – Connect to sensor ground

AEM P/N **30-2010 (Optional)** Air Temp Sensor kit is specifically designed for temperature measurements in automotive systems. The kit contains One GM style temperature sensor, one “6” Flying Lead” mating connector assembly and a weld in aluminum bung.

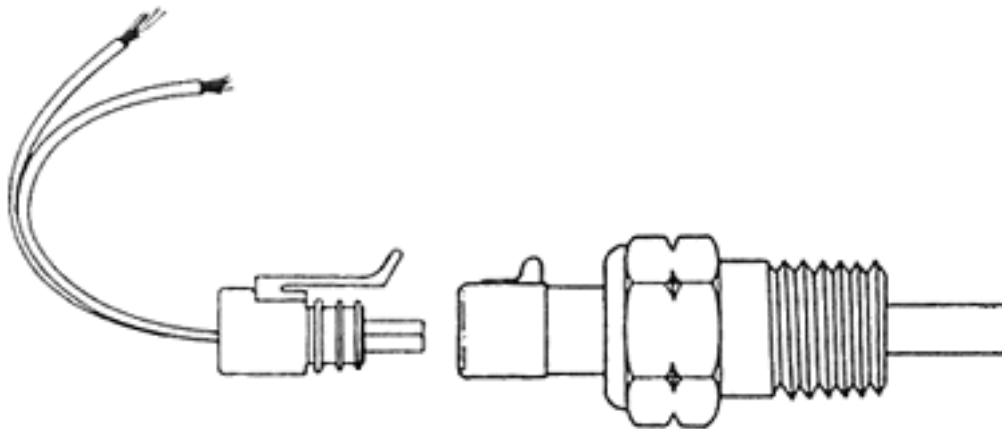

Air Temperature Sensor Diagram

Housing Material: Brass with 3/8” NPT Thread (Torque to 25 Ft-Lbs)

Elec. Termination: Integral weatherproof connector, Includes mating connector with 6” leads, 18 AWG.

Wiring to your EMS: Polarity does not matter. Connect one wire to harness AIR TEMP lead and the other to harness SIG GND lead.

Water Temp Sensor

Harness Connections

Water Temperature Sensor Harness Connections

Name	Wire	Wire Color	Stamping
Coolant Temp Sensor	22	White	COOLANT
Sensor Ground	22	Black	SIG GND

COOLANT – Connect to sensor signal

SIG GND – Connect to sensor ground

AEM P/N **30-2011 (Optional)** Water Temp Sensor kit is specifically designed for temperature measurements in automotive systems. The kit contains One GM style temperature sensor, one “6” Flying Lead” mating connector assembly and a weld in aluminum bung.

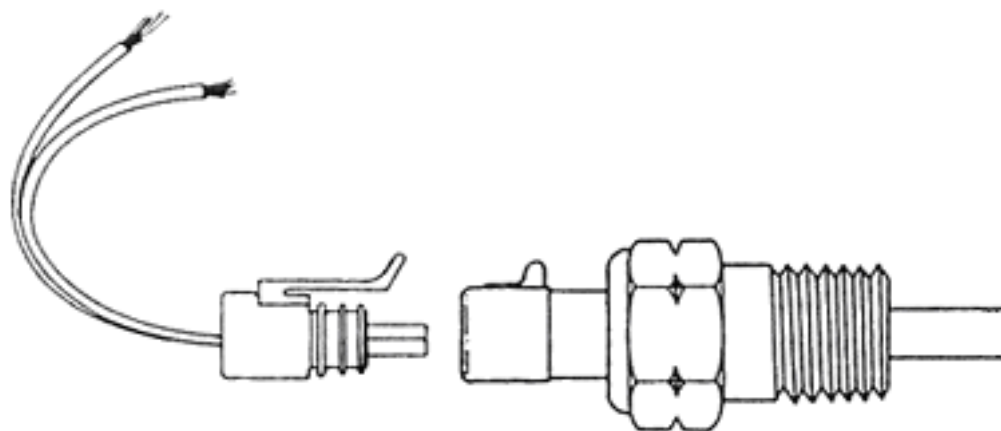

Water Temperature Sensor Diagram

Housing Material: Brass with 3/8” NPT Thread (Torque to 25 Ft-Lbs)

Elec. Termination: Integral weatherproof connector, Includes mating connector with 6” leads, 18 AWG.

Wiring to your EMS: Polarity does not matter. Connect one wire to harness COOLANT lead and the other to harness SIG GND lead.

Crank Sensor

Crank Sensor Basics

The crank sensor is used to calculate engine speed, ignition timing and injection phasing angles. It senses a toothed wheel (reluctor wheel, reluctor ring, etc.) and converts this pattern into a voltage/frequency signal that the EMS uses for basic calculations. Either on its own, or combined with the cam position sensor, it is the most important input to the system. There are two basic types of crank sensors, variable reluctance (VR or “mag”) and hall-effect.



VR Sensor raw voltage signal



Hall Effect voltage signal

The internal circuitry on the EMS is different depending on what type of sensor is being used. Note that there are two different inputs on the EMS for crank and cam position. One for a Hall Effect type pickup. The other for a VR or “mag” pickup.

The EMS-4 crank sensor VR inputs go through a signal conditioning chip on the circuit board that converts the raw (zero crossing) signal into a clean 0-5V square wave signal as shown below. The signal conditioning circuit will invert the significant edges of the raw signal. The consistent edge of the raw signal in the example below is the rising edge. The conditioning circuit inverts the signal and creates a falling significant edge.

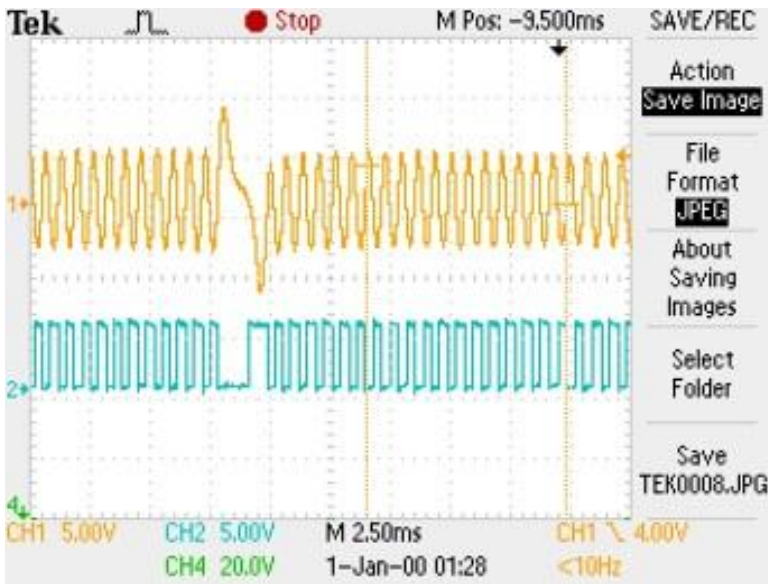

Shows signal conditioning with edge invert on typical “missing tooth” style VR crank sensor pattern

Internal Signal Conditioning Example

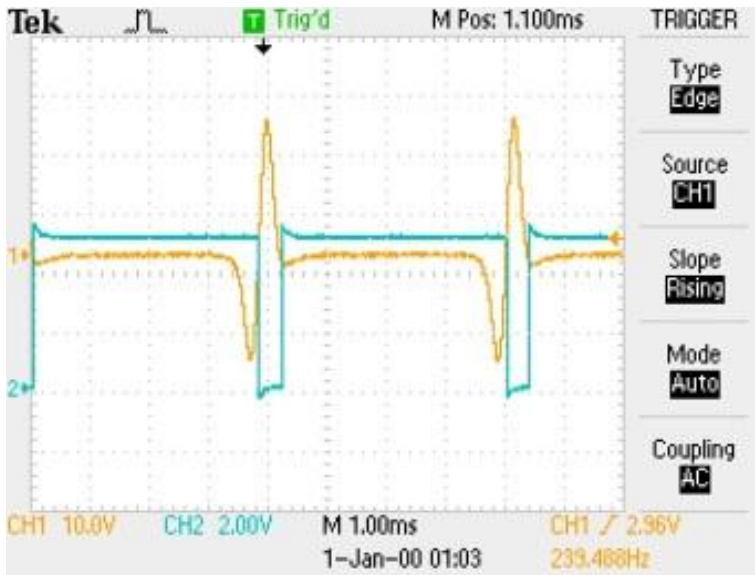

Shows signal conditioning with edge invert on typical evenly spaced VR crank pattern.

Internal Signal Conditioning Detail

All VR Crank Sensor inputs to the EMS-4 must be connected such that the rising edge of the raw sensor signal is the consistent zero crossing edge as shown in the examples above. Failure to do this could result in misfires or ignition timing inaccuracies. Verify data with an oscilloscope or contact your sensor manufacturer to verify polarity. The crank inputs to the EMS-4 are contained within a black shielded cable assembly as shown below. **Refer to the EMS-4 System Diagram for more information.**



Crank Sensor Input Cable End

Harness Connections

Crank Sensor Harness Connections

Crank Sensor Ground	28	White	
Crank Sensor Mag Input	28	Green	
Crank Sensor Hall input	24	Black	
+12 volts	24	Red	
Cable Shield	---		

Crank Sensor Mag Input, Green – Connect to VR (+) signal (rising edge zero cross). Not used for Hall sensor configurations.

Crank Sensor Hall input, Black – Connect to Hall sensor signal. Not used for VR sensor configurations.

+12 volts, Red – Connect to Hall sensor reference voltage. Not used for VR sensor configurations. ***Insulate if not using (hot at key-on).***

Crank Sensor Ground, White – Connect to Crank sensor VR (-) or Hall sensor signal ground

Cam Sensor

Cam Sensor Basics

The cam sensor is used to calculate engine position. It is necessary for sequential fuel calculations. It senses a toothed wheel (reluctor wheel, reluctor ring, etc.) and converts this pattern into a voltage/frequency signal that the EMS uses for basic calculations. Combined with the crank position sensor, it is one of the most important inputs to the system. There are two basic types of cam sensors, variable reluctance (VR or “mag”) and hall-effect.

All VR Cam Sensor inputs to the EMS-4 must be connected such that the rising edge of the raw sensor signal is the consistent zero crossing edge as shown in the examples above. Failure to do this could result in misfires or ignition timing inaccuracies. Verify data with an oscilloscope or contact your sensor manufacturer to verify polarity. The crank inputs to the EMS-4 are contained within a black shielded cable assembly as shown below. ***Refer to the EMS-4 System Diagram for more information.***



Cam Sensor Input Cable End

Harness Connections

Cam Sensor Harness Connections

Cam Sensor Ground	28	White	
Cam Sensor Mag Input	28	Green	
Cam Sensor Hall	24	Black	
+12 volts	24	Red	
Cable Shield	---		

Cam Sensor Mag Input, Green – Connect to VR (+) signal (rising edge zero cross). Not used for Hall sensor configurations.

Cam Sensor Hall, Black – Connect to Hall sensor signal. Not used for VR sensor configurations.

+12 volts, Red – Connect to Hall sensor reference voltage. Not used for VR sensor configurations. *Insulate if not using (hot at key-on).*

Cam Sensor Ground, White – Connect to Crank sensor VR (-) or Hall sensor signal ground

Vehicle Speed Sensor (VSS)

Vehicle Speed Sensor Basics

The vehicle speed sensor must be a hall-effect device. It is used to detect wheel speed for use in various EMS-4 software functions.

Harness Connections

Vehicle Speed Sensor Harness Connections

Name	Wire	Wire Color	Stamping
VSS Ground	22	Black	PWR GND
VSS Hall Input	22	White	VSS
+12.0 volts	22	Red	PWR

PWR GND – Connect to vehicle speed sensor ground pin.

VSS – Connect to vehicle speed sensor signal pin.

PWR – Connect to vehicle speed reference voltage pin.

Fuel Pump and Idle Air Control Example Circuits

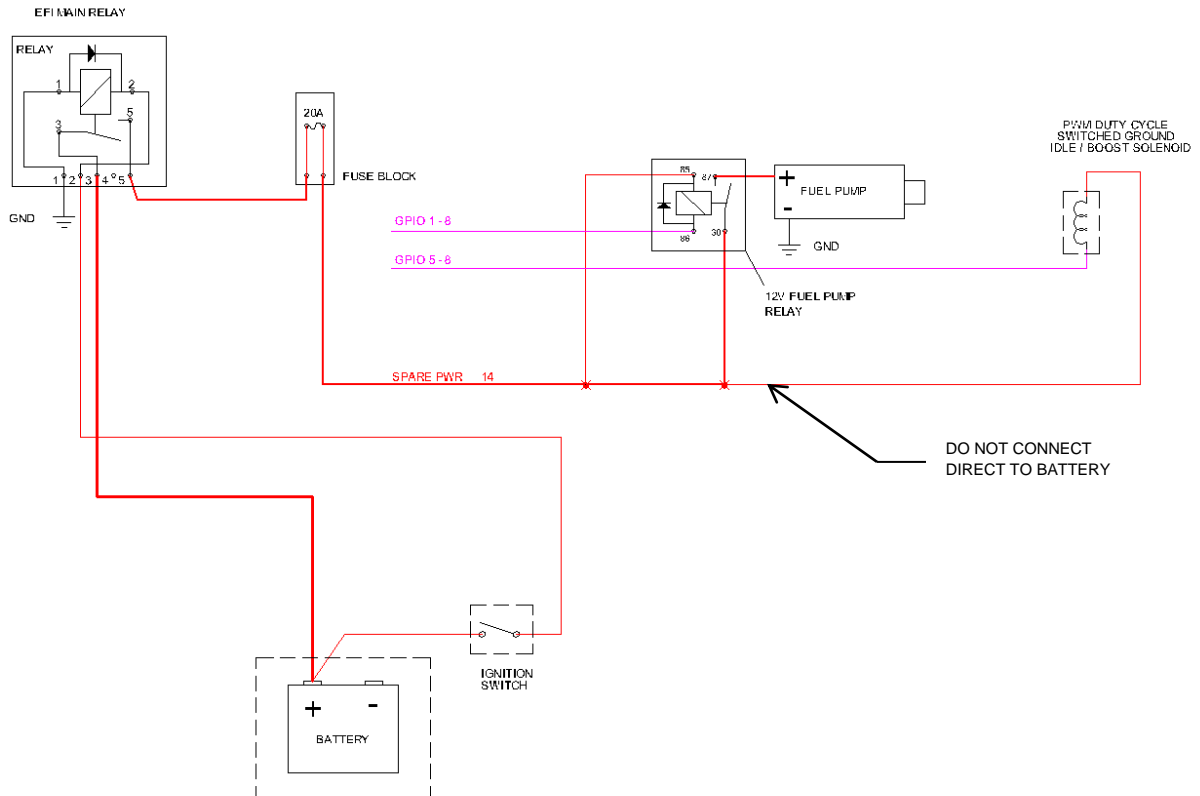

The example above shows proper wiring design for inductive loads like fuel pump relays and idle air control/boost control solenoids. Note that simple on/off type outputs from the EMS-4 can be connected to any GPIO output but Pulse Width Modified (PWM) circuits such as those used for idle control or boost control must be connected to GPIO 5 – 8, pins 14 – 17 on the 36 way ECU connector. **Note that the EMS-4 does not support Stepper Motor idle air control valves. Do not connect the power side of any actuator (relay, solenoid, etc.) direct to the battery.** Only use switched, fused power as shown above. Refer to the EMS-4 System Diagram for more information.

Part 2 – AEM Tuner

Software Installation

All current AEM Tuner software installations are available for download from the AEM Performance Electronics Forum at:

<http://forum.aempower.com/forum/index.php>

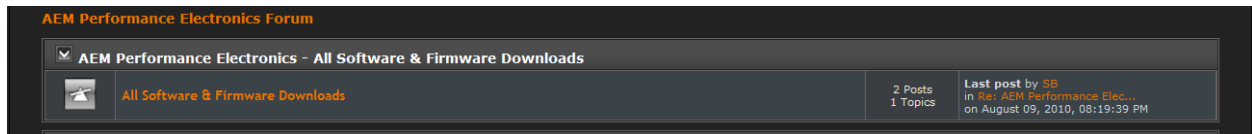

All Software Downloads Link

Click on the *All Software & Firmware Downloads* forum.

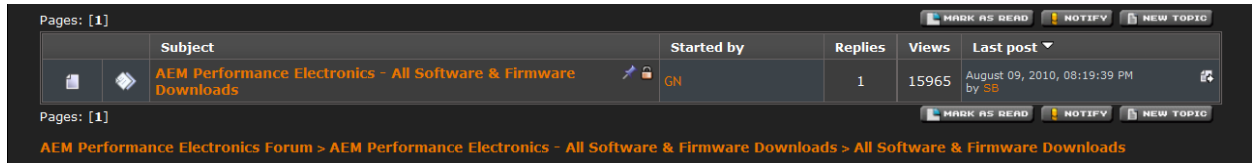

Software Downloads Link

Next click on the *AEM Performance Electronics – All Software & Firmware Downloads* forum

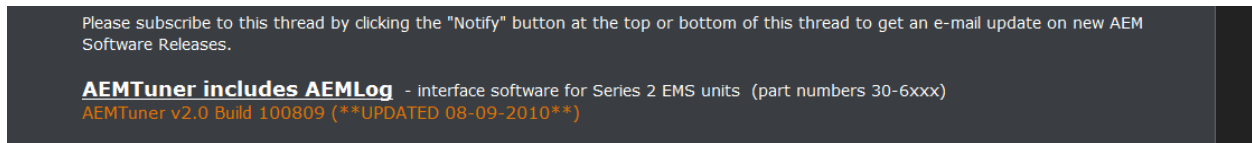

Software Downloads Link

Next click on the link shown above to reach the official download page. Note that you can subscribe to this thread to be notified when software updates are released.

AEMTuner v2.0 Build 100809 (**UPDATED 2010-08-23**)

Following is a summary of revisions included in Tuner 2.0 and firmware version 17. The release notes include much more detail, and can be found in the C:\Program Files\AEM\AEMTuner\Instructions folder.

Quick summary:

1. Improved AEM Tuner Menus and Workspace Layout
2. Mitsubishi Quick Start (01v17 firmware)
3. Better Idle Control (01v17 firmware)
4. Improved Mass Airflow Strategy (01v17 firmware)
5. Better Knock Control (01v17 firmware)
6. Serial Telemetry broadcast (01v17 firmware)
7. Improved Rev Limiters (01v17 firmware)
8. Simplified Dwell Control (01v17 firmware)

AEMTuner V2.0 – Improvements since V1.91:

- Improved Auto Display Layout feature.
- 2D table header column width now stored in workspace.
- Improved control when resizing 2D or 3D displays.
- Added menu item to show current workspace name.
- Reorganized "File" menu to minimize mouse clicking for frequently used tasks.
- Improved algorithm to access calibration 2D/3D table more efficiently.
- Option displays now compatible with hex format options.
- Smart table conversion added to minimize the number of items users must update in their calibration file when converting to firmware version 01V17.
- Fixed bug that caused the "+" key to make a beeping sound.
- If the scrollbar was visible, displays sometimes would not snap to grid when moved. This is now fixed.
- Fixed bug that kept options table display layout preferences from being saved in workspace.
- 2D/3D Display split information is now stored in workspace.
- Fixed bug that caused an error when displaying Series 1 EMS v1.19 calibrations. Note: AEMTuner is not 100% compatible with Series 1 EMS hardware.
- Fixed injector and coil phasing options display bug.
- Menu items "save workspace" and "save calibration" now disabled when workspace or calibration is not modified.

Software Installation Revision Notes Example

All current software releases will include a set of revision notes describing feature changes or additions since the last update.

SOFTWARE REQUIREMENTS

- Microsoft .Net 2.0 SP2 or .Net 3.5 SP1(for Vista user). You can get them at the following address:

.Net 2.0 SP2:

<http://www.microsoft.com/downloads/details.aspx?familyid=5B2C0358-915B-4EB5-9B1D-10E506DA9D0F&displaylang=en>

.Net 3.5 SP1:

<http://www.microsoft.com/downloads/details.aspx?familyid=AB99342F-5D1A-413D-8319-81DA479AB0D7&displaylang=en>

HARDWARE REQUIREMENTS

- USB 2.0. (USB1.1 is not support by AEMTuner).

INSTALLATION

1. Download the installer from here:

ftp://aem:a3m@216.23.176.210/cust/AEMTuner_v2.0.exe

2. Double click the downloaded file to install.

3. By default, the installer will install sample calibrations and a sample workspace. Be sure to select them if this is your first time setup.

- How to Install USB Driver?

There is no need to install USB drivers unless you need to connect to an old EMS unit that is using 01v11 firmware or older. See the C:\Program Files\AEM\AEMTuner\Old USB Drivers folder for more info.

FEEDBACK

You can provide feedback to us about the software on this forum. There is a forum for reporting bugs you encounter:

<http://forum.aempower.com/forum/index.php/board,86.0.html>

There is also a forum to provide suggestions for new Functionality:

<http://forum.aempower.com/forum/index.php/board,85.0.html>

When providing functionality suggestions please remember that this software is the tuning tool ONLY, it can interface and adjust calibration values but will not change the functions of the EMS itself.

We hope you see AEMTuner as a step forward for our EMS, and look forward to hearing your feedback!



Software Installation Instructions

Follow the Installation Instructions as outlined above.

After the software installation is complete, click on the AEM Tuner icon to launch the application.

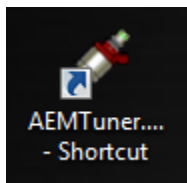

AEM Tuner Shortcut

AEM Tuner

When AEM Tuner launches, the application will begin with a window similar to the one below:

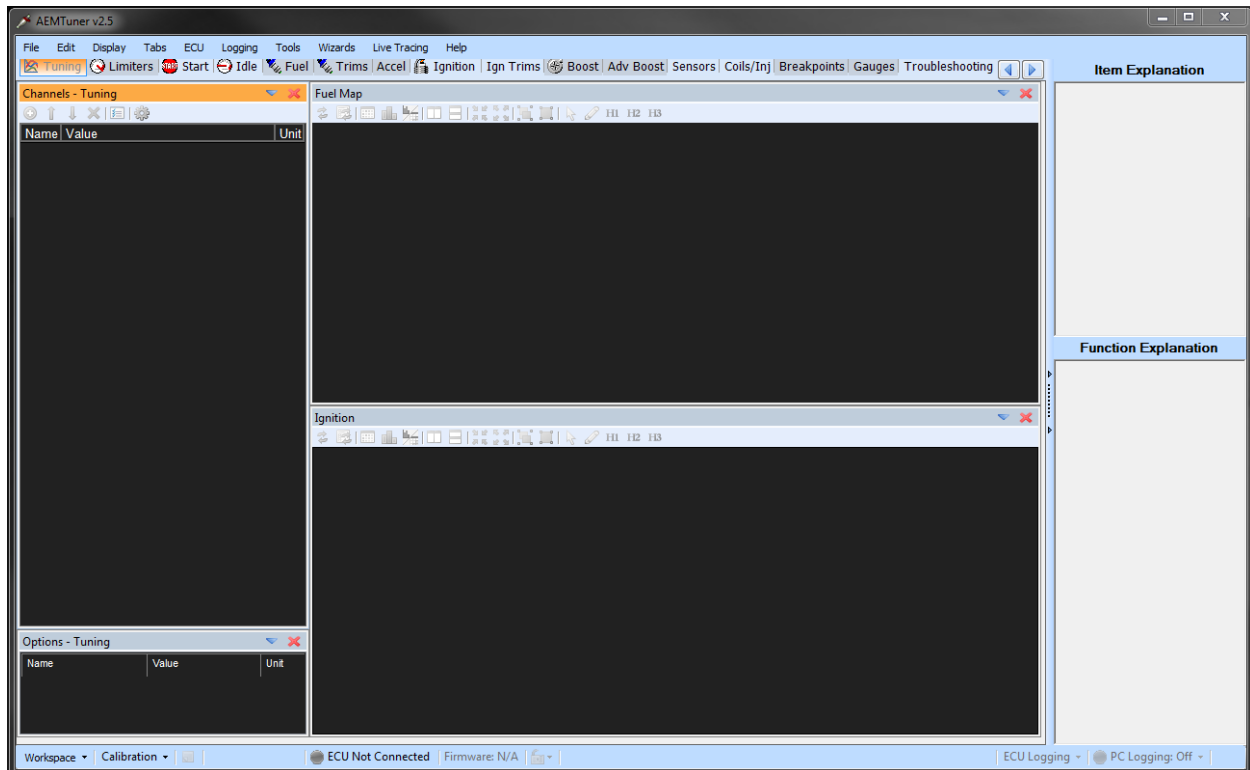

AEM Tuner Environment

Basic Terminology

Calibration File – The calibration file is what the tuner modifies and will be specific to the engine setup.

Options – Single values that are set by the user to change the operation of an EMS.

Channels - Channels are data for viewing and logging. They are a window to the engine. They tell you everything the engine is doing and what all of the sensors are seeing. This window is one of the most valuable tools in helping to tune the engine.

Tables – Tables are two dimensional data sets that define one value as a function of another.

Maps – Maps are three dimensional data sets that define one value as a function of two others.

Tabs – Tabs are screen templates that the user can create and edit to group sets of calibration data as needed.

Workspace – User defined AEM Tuner configuration settings that include in part: Basic application preferences, the display settings, the number of tabs displayed and the tab configuration, color preferences, unit preferences, hot keys, etc.

Item Explanation

Boost Error Duty (%) vs Boost Error Table.

Closed loop feedback duty correction for boost error.

Generally used to increase duty cycle when Boost Error is negative (actual Engine Load is less than desired Boost Target) and decrease duty cycle when Boost Error is positive (actual Engine Load is greater than desired Boost Target).

Function Explanation

By default the boost target is determined by the [Boost Target RPM/TPS](#) map. If the vehicle speed based boost target is active ([Boost FB VSS](#)) then the [Boost Target VSS](#) table is used to determine the target boost. The target can always be overridden by the [Switch is Always OFF](#) switch input. If it is then the boost target goes to [7.1](#).

The wastegate solenoid is on the [PW 2](#) output. The duty cycle for the solenoid is drawn from the [Boost WG Base Duty](#) map. The [Boost Target Comp](#) table can be used to create a global correction factor for the Boost WG Duty map when the target boost varies as a function of speed etc...

The maximum duty the boost control solenoid can

gging ▾ | PC Logging: Off ▾

Item Explanations - Item Explanations provide a brief description of what the currently selected in the currently selected Display does, or is used for. So, for example, if the selected Display was an Options Display, the Item Explanation would describe the selected Option with that selected Options Display. For Calibration items (Options and Tables) this explains how the ECU uses that item to accomplish a function. For Log items (Channels) this explains what the value represents to the ECU.

Function Explanations - Function Explanations provide an in depth explanation of the way Options, Tables and Channels work together in the ECU to accomplish a function. Here a function just means anything that the ECU needs to control. So, for example, firing the fuel injectors is a function, or controlling a boost control solenoid is a function. Function explanations are associated with the selected Display, so selecting a Display is the only way to change the Function Explanation displayed.

Links - Function Explanations can contain links to the Calibration and Log items they refer to (Options, Tables, and Channels). Links are indicated with blue underlined text, just as the standard hyperlinks in a web browser are. When the user clicks on a link the item (either Calibration or Log) the link references will be added to the appropriate Display on the current Display Sheet and selected, giving it focus. If that item already exists in a Display on the current Display Sheet, then the item will just be selected. So, for example, if the user clicks a link representing the "WG Base Duty" map (as seen in example of the left) the 3D Map Display containing that table would be opened (unless it already existed on the Sheet) and that Display would become selected.

Option links are treated differently from Table and Channel links. Instead of just displaying the name of the Option in the link, its current value from the loaded Calibration is used, to provide an even more meaningful description of how your particular car is setup. So if a link is simply a number, it is an Option link. It can still be clicked just as Table and Channel links are, and the referenced Option will be displayed and selected.

Menu Items

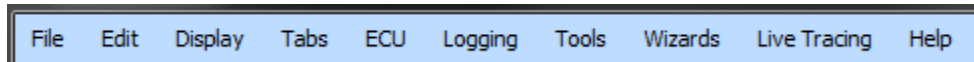

Following is a basic description of each menu function.

FILE

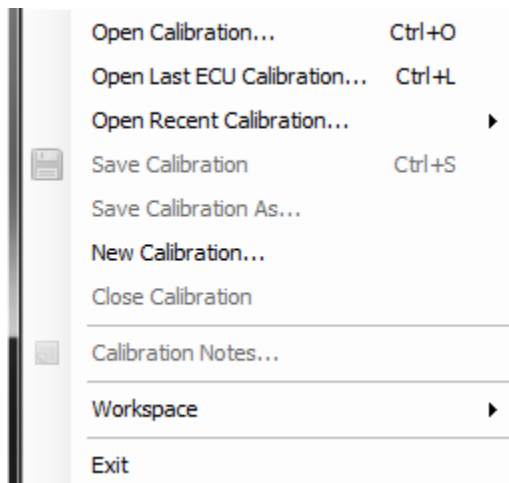

Open Calibration - Opens a previously saved calibration file

Open Last EMS Calibration – Opens the last calibration file saved in memory

Open Recent Calibration – Displays a list of recent opened calibrations files. Choose one to open.

Save Calibration – Saves currently loaded calibration file with the same file name. Only active when a calibration file is loaded.

Save Calibration As – Saves the currently loaded calibration with the option of changing the file name.

New Calibration – Creates a new blank calibration file.

Close Calibration – Closes the currently loaded calibration file.

Calibration Notes – Allows the user to enter text that describes the calibration file.

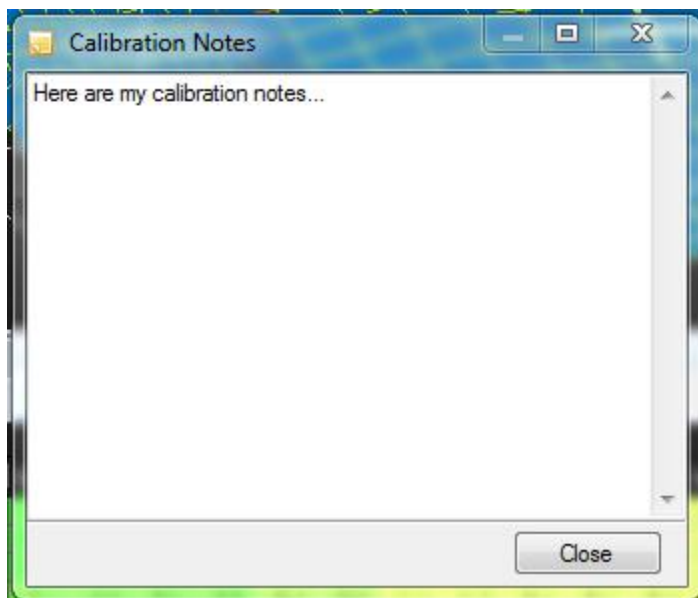

Calibration Notes

Workspace

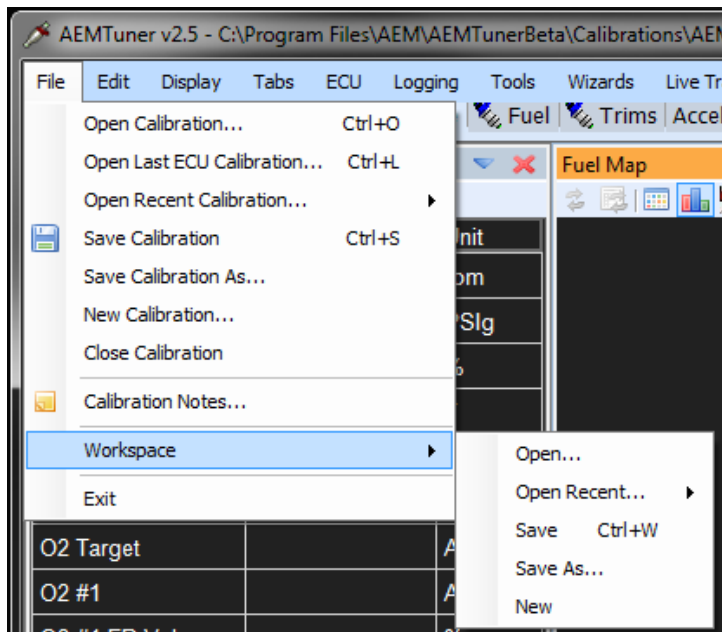

File-Workspace

Workspace – Open – Opens a previously saved workspace file.

Workspace – Open Recent – Displays a listing of recently opened workspace files.

Workspace – Save – Saves the current workspace file under the same filename.

Workspace – Save As – Saves the current workspace with the option of choosing a new filename.

Workspace – New – Creates a new blank workspace.

Exit – Closes the AEM Tuner application.

EDIT

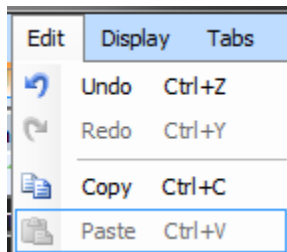

Edit Menu

Undo - Undoes the last change made to the loaded calibration. Does not undo changes made to the workspace or Application Preferences, only the loaded calibration.

Redo - Redoes the last change Undone in the system. Does not redo changes made to the workspace or Application Preferences, only the loaded calibration.

Copy - Copies the currently selected calibration value from the selected Display into the system's clipboard. This can be used to copy multiple cells in a 2D or 3D table. In this case the values are copied in a csv (Comma Separated) format that can be pasted into an Excel spreadsheet.

Paste - Pastes the value in the system's clipboard to the selected item in the selected Display. It can be either a number (for Options and Tables), or a set of numbers in csv (Comma Separated) for tables. If pasting into a table, the number of values in the clipboard does not need to match the number of cells selected to be pasted into. In this case the values from the clipboard will be interpolated to fit into the selected cells of a table.

DISPLAY

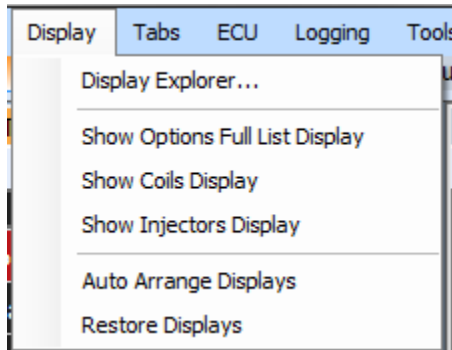

Display Menu

Display Explorer – Opens a separate window where the user can select options, channels, tables or maps for use in the current tab. Browse through the list of available displays and double click on one to add it to the current tab.

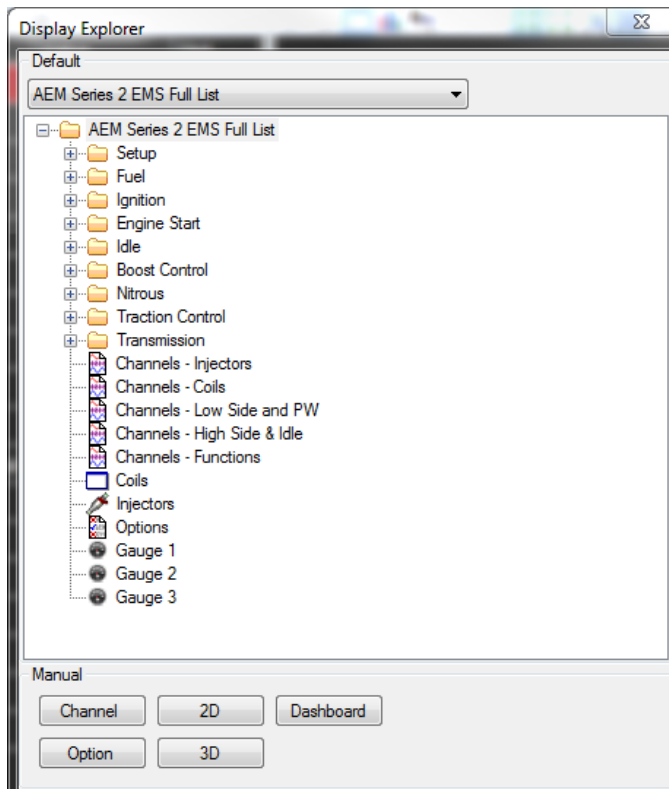

Display Explorer

Show Options Full List Display – Opens a display that contains all available options for the current calibration type. Used for internal AEM diagnostics only.

Show Coils Display – Opens a display that contains selections for activating and configuring ignition coil outputs.

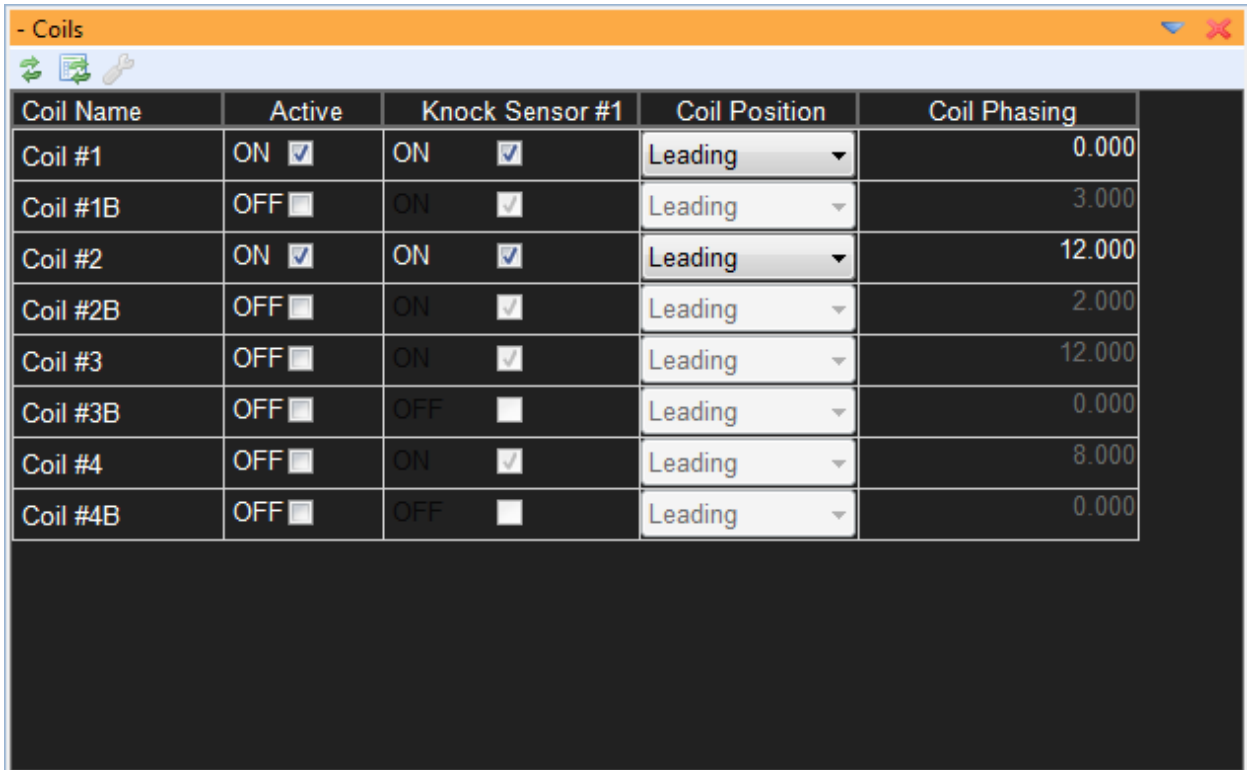

The screenshot shows a software window titled "- Coils" with a toolbar containing icons for refresh, save, and help. Below the toolbar is a table with the following columns: Coil Name, Active, Knock Sensor #1, Coil Position, and Coil Phasing. The table lists eight coils with their respective settings.

Coil Name	Active	Knock Sensor #1	Coil Position	Coil Phasing
Coil #1	ON <input checked="" type="checkbox"/>	ON <input checked="" type="checkbox"/>	Leading	0.000
Coil #1B	OFF <input type="checkbox"/>	ON <input checked="" type="checkbox"/>	Leading	3.000
Coil #2	ON <input checked="" type="checkbox"/>	ON <input checked="" type="checkbox"/>	Leading	12.000
Coil #2B	OFF <input type="checkbox"/>	ON <input checked="" type="checkbox"/>	Leading	2.000
Coil #3	OFF <input type="checkbox"/>	ON <input checked="" type="checkbox"/>	Leading	12.000
Coil #3B	OFF <input type="checkbox"/>	OFF <input type="checkbox"/>	Leading	0.000
Coil #4	OFF <input type="checkbox"/>	ON <input checked="" type="checkbox"/>	Leading	8.000
Coil #4B	OFF <input type="checkbox"/>	OFF <input type="checkbox"/>	Leading	0.000

Coils Display

Show Injectors Display – Opens a display that contains selections for activating and configuring injector outputs.

Injector Name	Active	Knock Sensor #1	O2 Feedback	EGT Feedback
Injector #1	ON <input checked="" type="checkbox"/>	ON <input checked="" type="checkbox"/>	O2 #1	EGT #1
Injector #2	ON <input checked="" type="checkbox"/>	ON <input checked="" type="checkbox"/>	O2 #1	EGT #1
Injector #3	ON <input checked="" type="checkbox"/>	ON <input checked="" type="checkbox"/>	O2 #1	EGT #1
Injector #4	OFF <input type="checkbox"/>	ON <input checked="" type="checkbox"/>	O2 #1	EGT #1

Injectors Display

Auto Arrange Displays – Automatically organizes the displays within the current tab so that none are overlapping.

Restore Displays – Restores the workspace settings back to the previously saved settings.

TABS

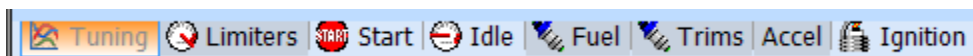

AEM Tuner Tabs

The Tabs menu item lists all currently saved tabs screen templates. Right clicking in the tab area of the menu space shown above will bring up the following menu:

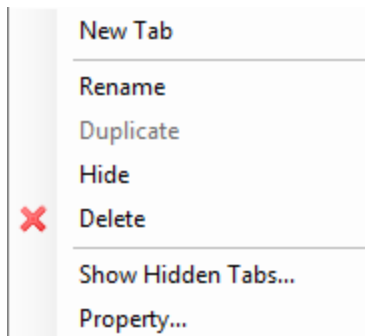

Tabs Menu

New tabs can be created. Existing tabs can be renamed hidden or deleted. Currently hidden tabs can be displayed for re-use and all tab properties can be modified by selecting the Property item.

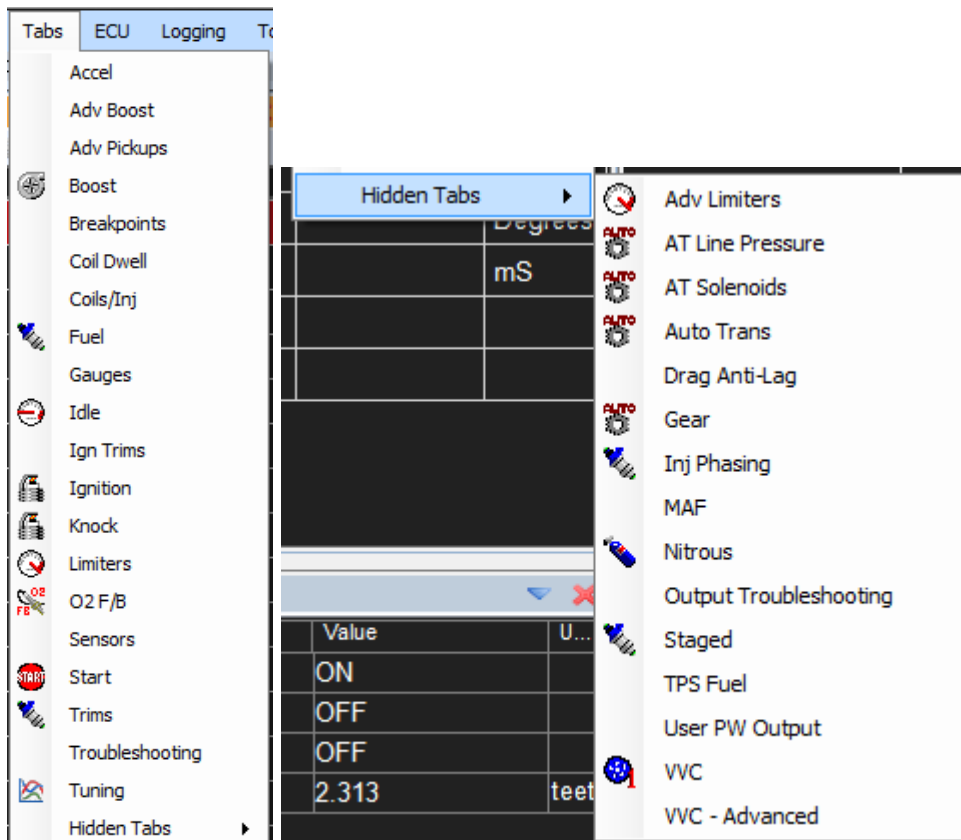

Tabs Menu Detail

Tabs are saved as part of the Workspace configuration. Remember to save the workspace to retain your changes.

ECU

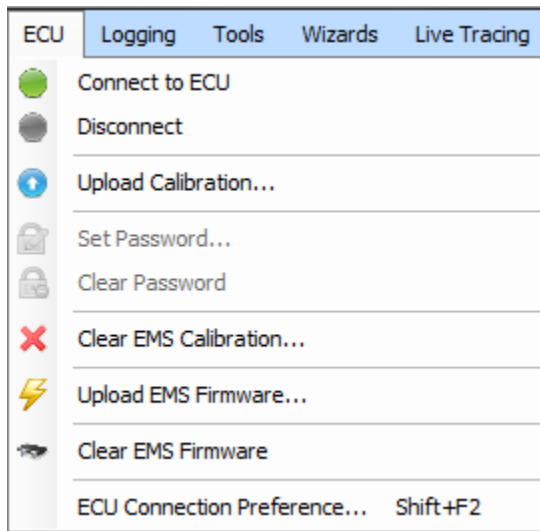

EMS Menu

Connect to ECU – Instructs AEM Tuner to attempt a communications connection with the EMS hardware.

Disconnect – If connected, instructs AEM Tuner to close the communications connection with the EMS.

Upload Calibration – Loads a new calibration file into the EMS.

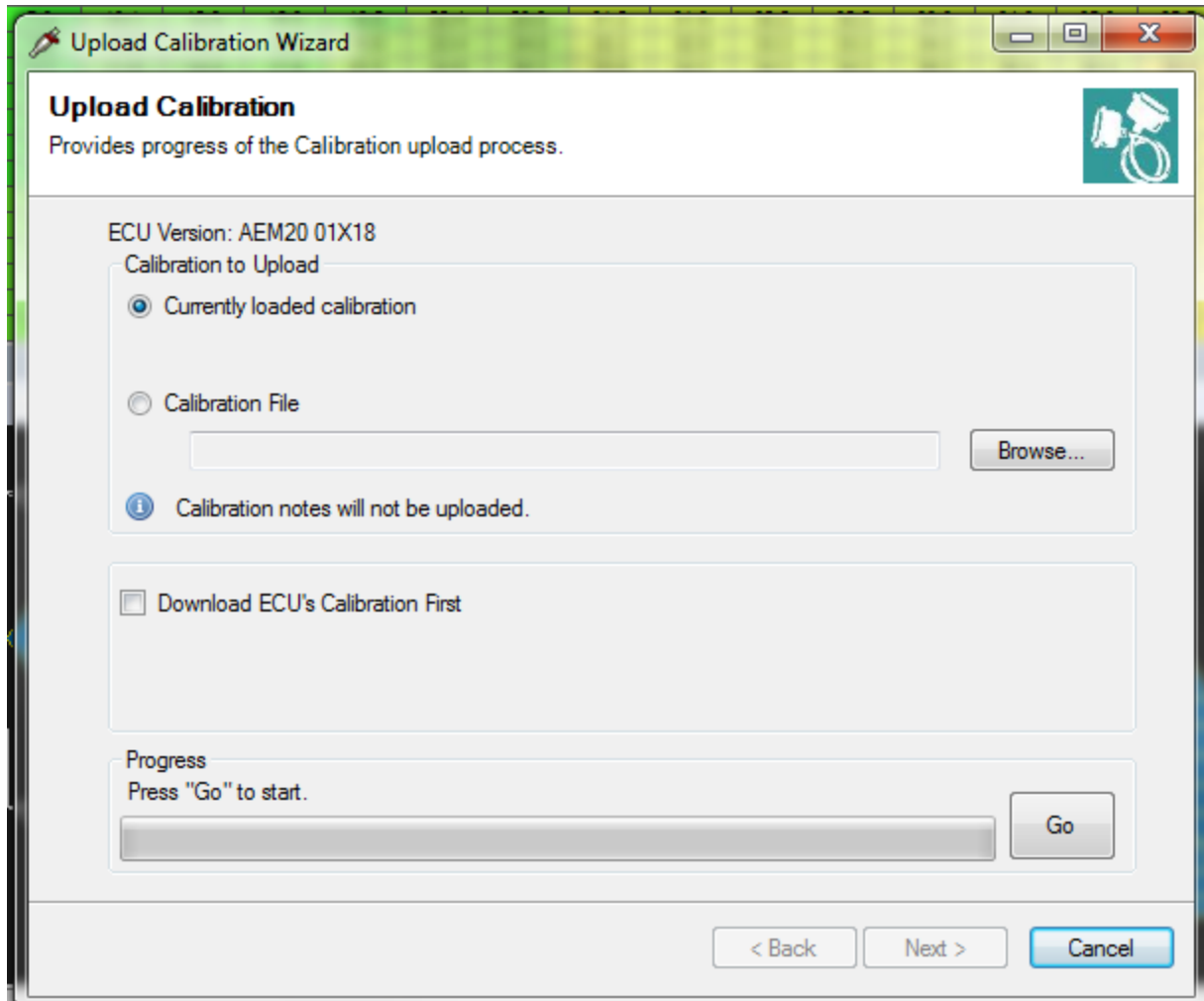

Upload Calibration Dialog

Click the Browse button to select a calibration file. Note that the calibration firmware version must match the EMS firmware version. The current EMS version is displayed at the top of this window. An optional check box labeled Download EMS's Calibration First allows the currently loaded calibration file to be saved prior to loading the new one. When the desired calibration file is chosen, click on the Go button to load it into the EMS. Follow the on-screen instructions and cycle power afterwards.

Set Password – Allows the user to define a password for the EMS calibration. Must be connected to an EMS for this function to become available.



Set Password Dialog

Clear EMS Calibration – Clears the currently loaded calibration from EMS memory.

Upload EMS Firmware – Allows the user to update the EMS firmware to the most current revision. Follow the on-screen instructions to complete the upgrade. Note that a new calibration compatible with the new firmware version is required to complete the process.

Clear EMS Firmware – Clears the currently loaded firmware version. Follow the on-screen instructions to complete the process.

EMS Connection Preference – Allows the user to choose how AEM Tuner will connect with the EMS. Note that EMS-4 systems do not have a serial port connection capability.

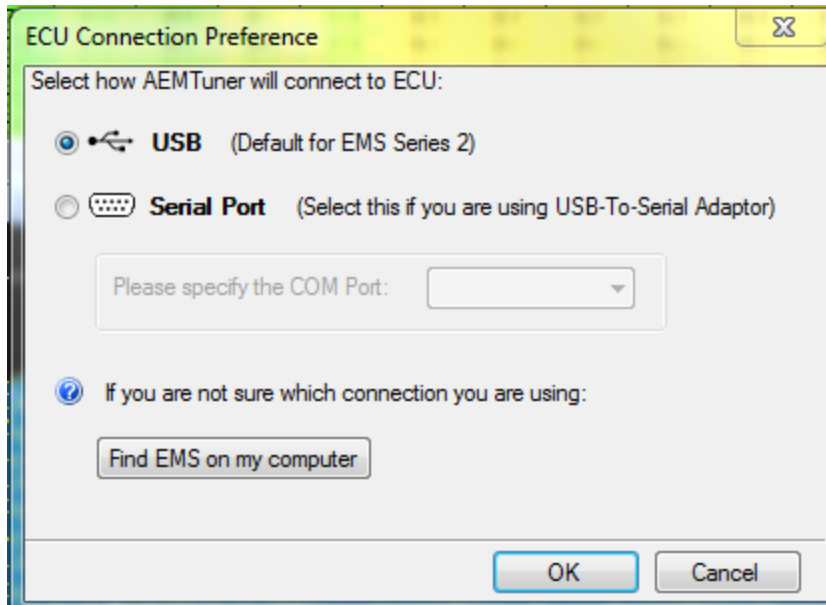

EMS Connection Preference Dialog

LOGGING

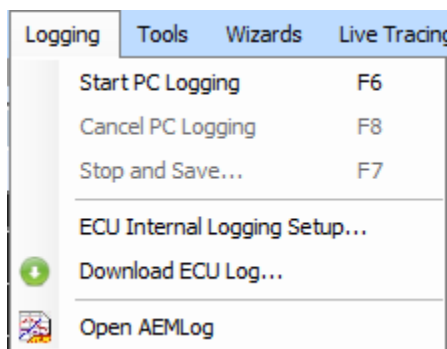

Logging Menu

Start PC Logging – (F6 Hotkey) will log data from all channel displays in the active tab.

Cancel PC Logging – (F8 Hotkey) will stop logging and discard the file.

Stop and Save – (F7 Hotkey) will stop logging and prompt the user to save the logged file.

EMS Internal Logging Setup – Opens a dialog window that allows the user to configure the internal logging settings of the EMS.

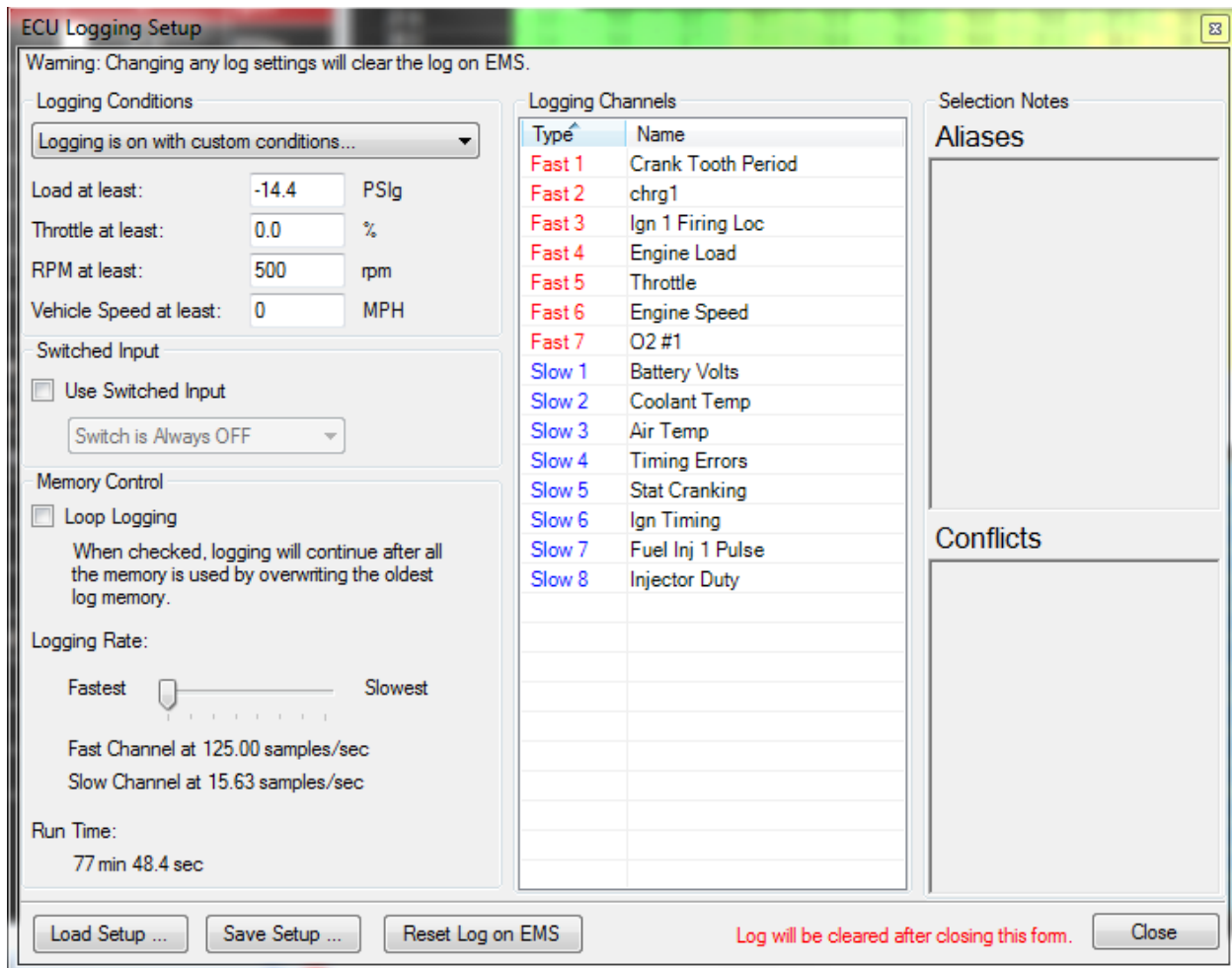

EMS Internal Logging Setup Dialog

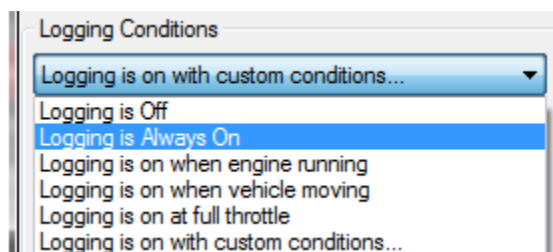

Logging Conditions

Logging Conditions – Defines the activation criteria for the internal logging function.

Logging is Off – Internal logging function is disabled.

Logging is Always On – When the EMS is powered up, the logger is logging.

Logging is on when engine is running – When engine speed is greater than 0, data will be logged.

Logging is on when the vehicle is moving – When the vehicle speed is greater than 0, data will be logged. Note that this setting requires a properly configured vehicle speed sensor.

Logging is on at full throttle – Data will be logged at wide open throttle only.

Logging is on with custom conditions – Logging activation is determined by the following settings:

Load at least:	<input type="text" value="-14.4"/>	PSIg
Throttle at least:	<input type="text" value="0.0"/>	%
RPM at least:	<input type="text" value="500"/>	rpm
Vehicle Speed at least:	<input type="text" value="0"/>	MPH

Logging Custom Conditions

Switched Input

Use Switched Input

Switch is Always OFF

Switch is Always ON

GPIO1 Gnd=On

GPIO1 12V=On

GPIO2 Gnd=On

GPIO2 12V=On

GPIO3 Gnd=On

GPIO3 12V=On

GPIO4 Gnd=On

GPIO4 12V=On

Log Switch Settings

Select *Use Switched Input* to define a log activation switch input from the drop down list.

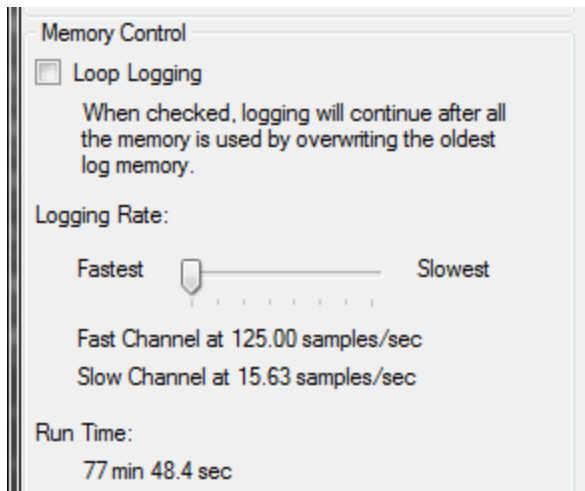

Internal Logging Memory Control

Select *Loop Logging* to continue logging after all memory is used. Only the oldest data will be lost when the log loops.

Use the slider to select the logging rate. The rate, channels selected and EMS logging memory capacity will be used to estimate the log run time.

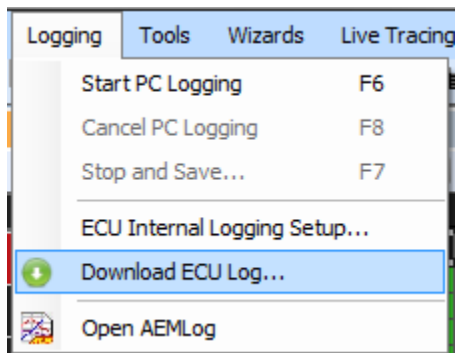

Download EMS Log Menu Item

Download EMS Log – Select this item when connected to the EMS to download the current logged data file.

Open AEMLog – Select this item to Open AEMLog data analysis software.

TOOLS

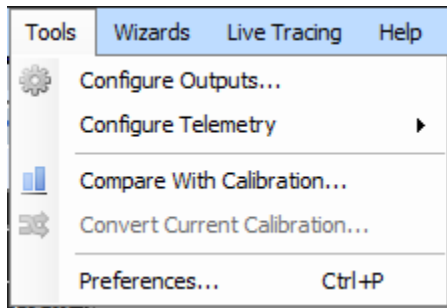

Tools Menu

Configure Output Dialog – Used to define the activation criteria for EMS configurable outputs.

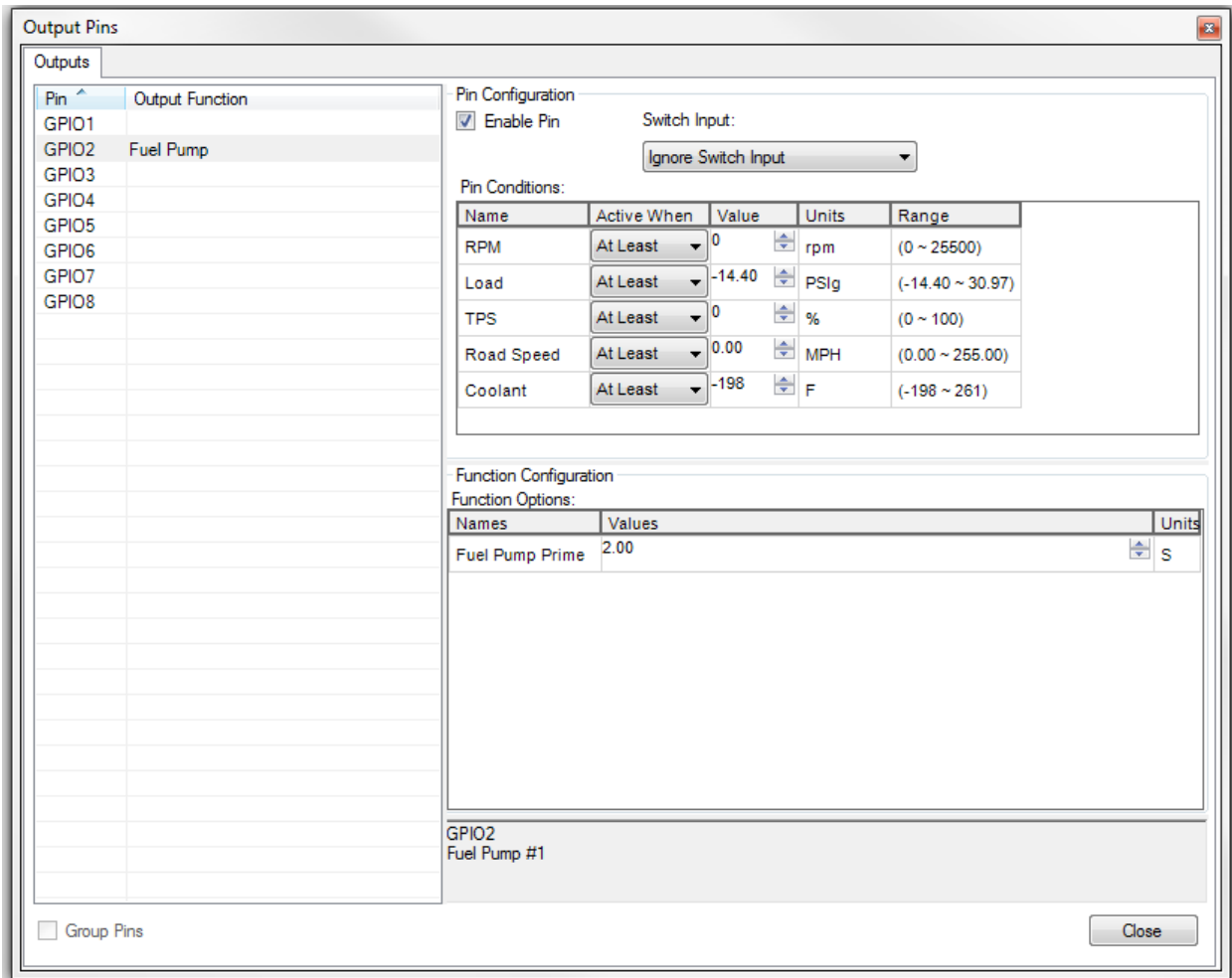

Configure Outputs Dialog

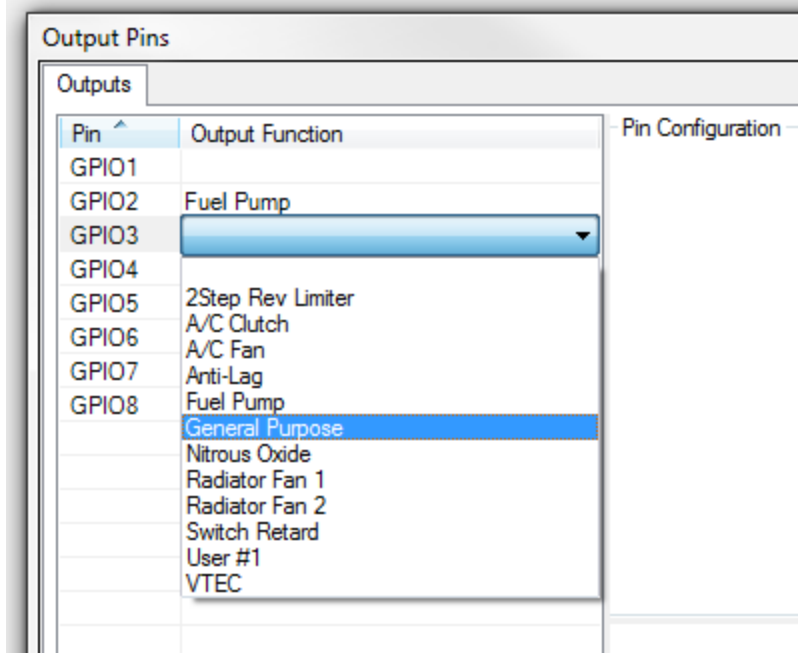

GPIO General Purpose Activation

To activate an output for a General Purpose Function, double click on the output function row/column cell adjacent to the output name as shown. Select General Purpose from the drop down list then hit the ENTER key to confirm.

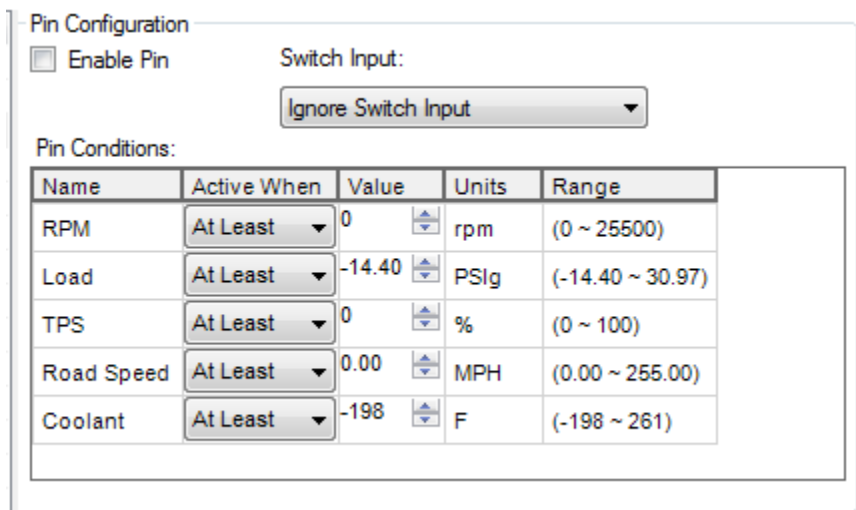

Output Activation Criteria

Under Pin Configuration, check the Enable Pin box to activate the output. The Switch Input drop down selection allows the user to select a switch input to manually activate the output. Note that the general pin conditions must also be met in addition to the switch input status for

the output to activate. To control the output using only the pin conditions, select Ignore Switch Input and set the activation conditions as needed. In the example above the following conditions must be true for the output to turn on:

- RPM greater than 0
- Engine Load greater than -14.40 psig
- Throttle Position greater than 0%
- Road Speed (Vehicle Speed) greater than 0
- Coolant Temperature greater than -198 deg F

Configure Telemetry Dialog – Allows the user to select custom settings for serial or CAN telemetry output. Note that the EMS-4 systems do not support serial comms or telemetry. EMS-4 systems communicate with the PC using USB only.

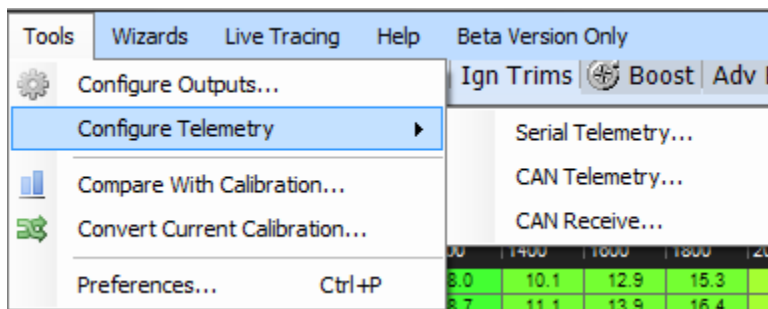

Telemetry Setup Menu Items

Calibration Compare Tool – Will compare two calibrations and allow the user to copy settings from one to the other.

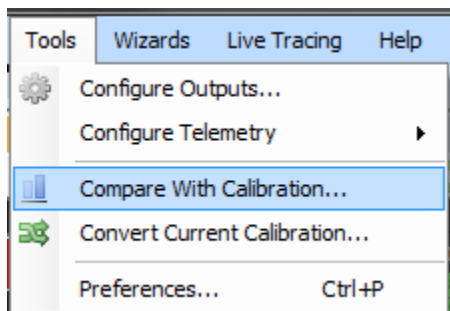

Compare With Calibration Menu Item

The calibration compare tool will compare the currently loaded calibration with a second one chosen by the user. With a calibration opened in AEM Tuner, the first step is to select the second calibration.

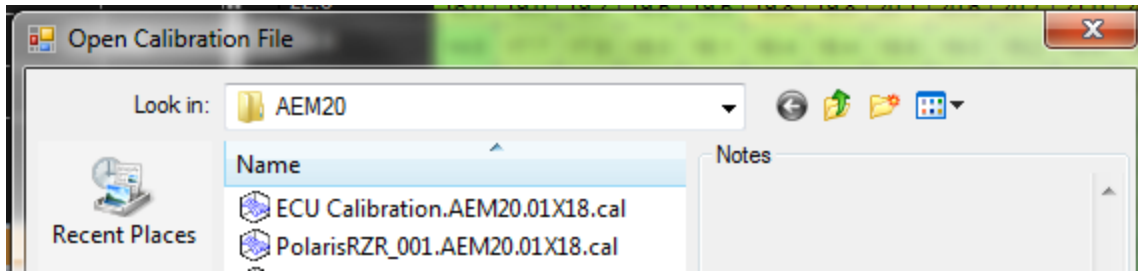

Compare - Open File Window

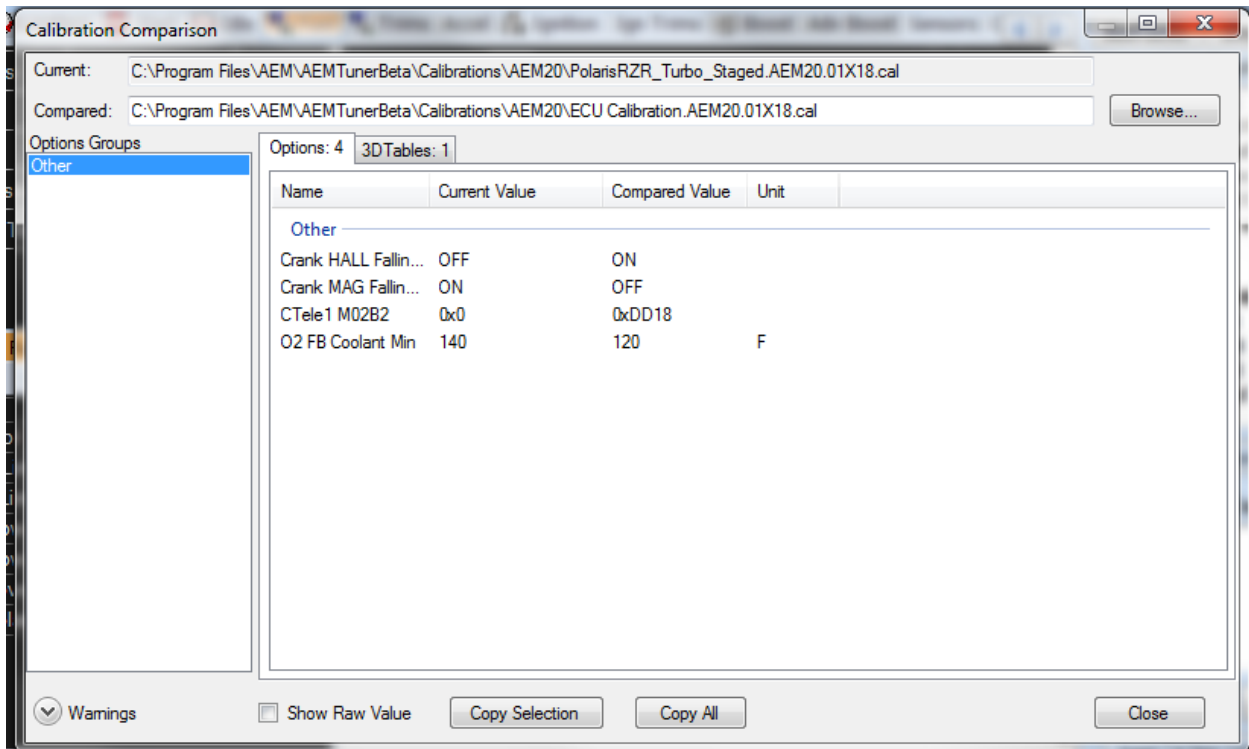

Calibration Compare Dialog

The tool will allow the user to choose and copy selected options, tables or maps values from the “Compared Calibration” to the currently opened calibration.

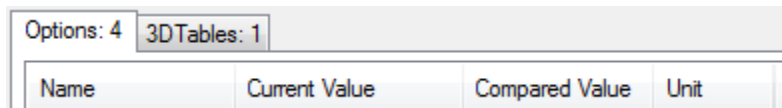

Compare Calibration Detail

The tabs at the top of the window allow the user to select between different types of data, options, tables or maps.

To copy a value, highlight it and click Copy Selection. Alternatively, all items can be copied at once by clicking the Copy All button.

Convert Current Calibration Tool – Will convert a calibration created in one EMS version to another EMS version. Calibration versions must match the version of software installed in the EMS. Software installed in the EMS is also referred to as firmware. The EMS firmware is constantly being upgraded and improved. When AEM releases a new version of firmware, the convert calibration tool allows customers to convert a previously tuned calibration so it is compatible with the new firmware revision.

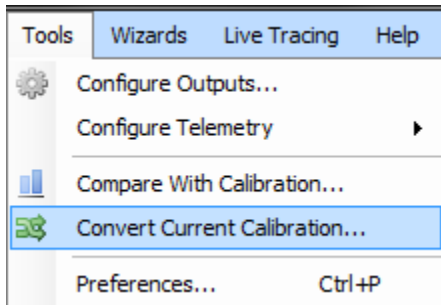

Convert Calibration Menu Item

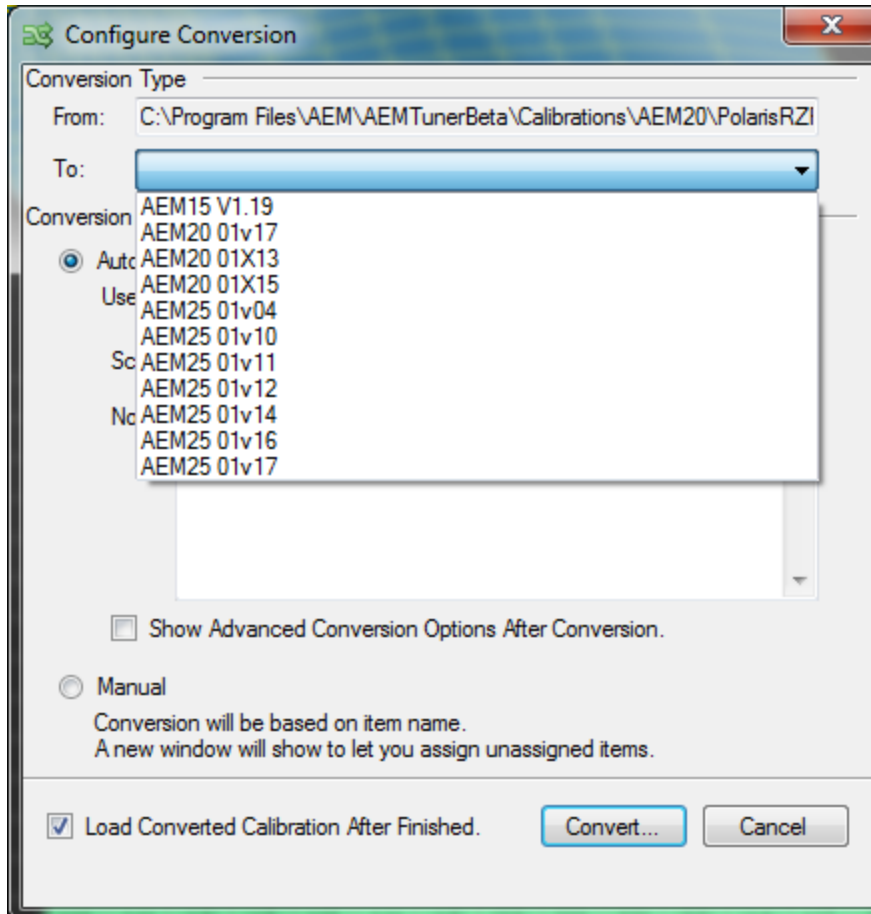

Configure Conversion Dialog

The first step is to choose the EMS version to convert the current opened calibration into. There are two different types of conversions, Auto and Manual. Manual conversions are usually for internal AEM use but these can also be accomplished by experienced users as well. Auto conversions employ a conversion script provided with the new firmware release. The conversion script simplifies the process limiting the number of decisions the user must make during the conversion process.

Preferences – The preferences tool is used to define many AEM Tuner application specific preferences.

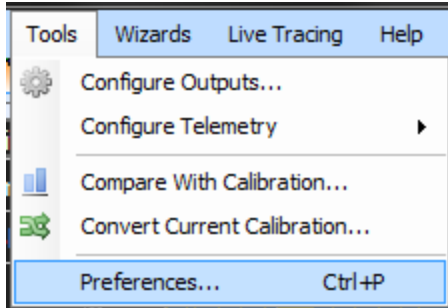

Tools - Preferences Menu Item

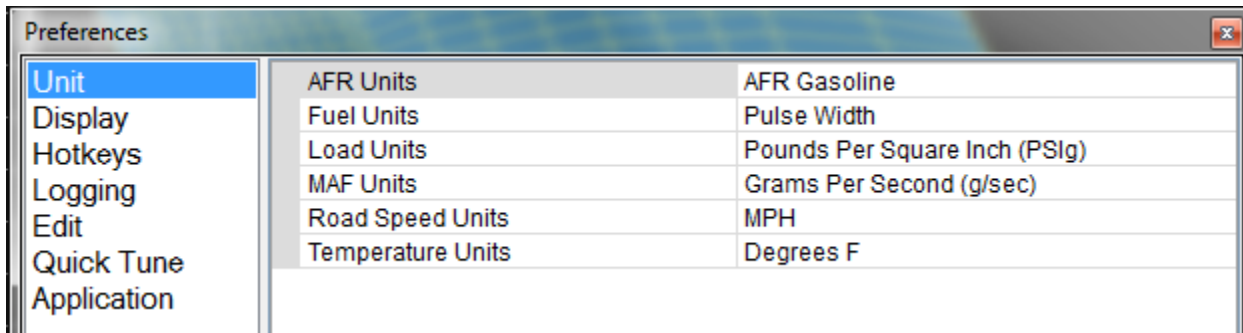

Unit Preferences

The first preference category allows the user to select their preferred units. This selection defines what units will be used in channel displays and logged data for each type.

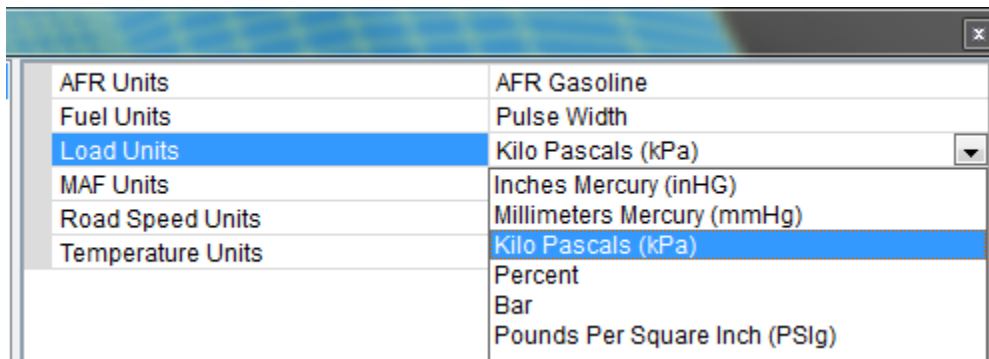

Unit Preferences Detail

The right hand column in this dialog includes drop down selection lists. Left click to activate the drop down then select from the list.

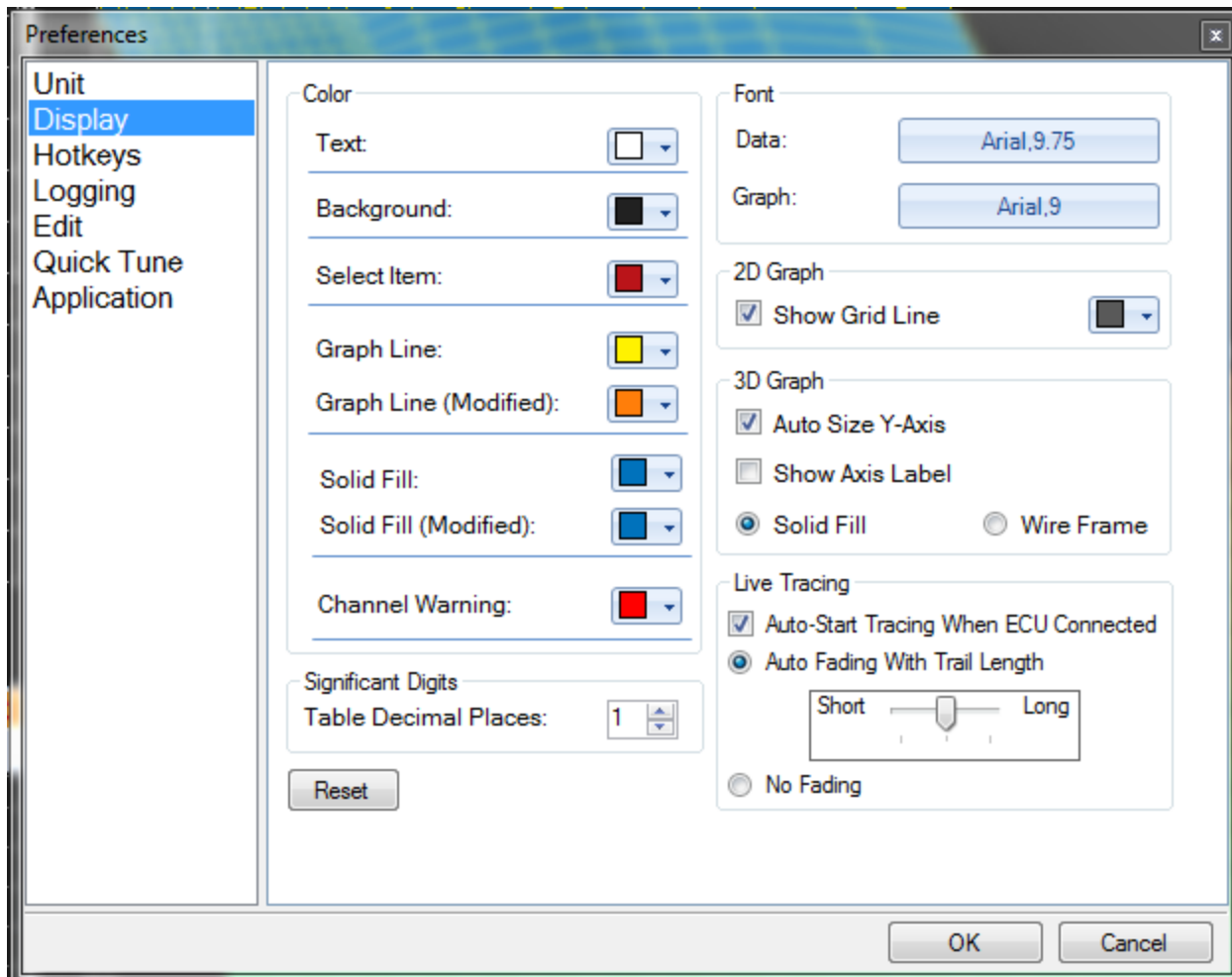

Display Preferences

The display preferences dialog includes basic color and font preferences for use in AEM Tuner. Experiment to find what works best. This dialog also includes preferences for Live Tracing. Live Tracing is used in maps to graphically highlight the areas of the map the EMS is accessing at any given point in time. This is only active when the EMS is powered up and connected to the PC.

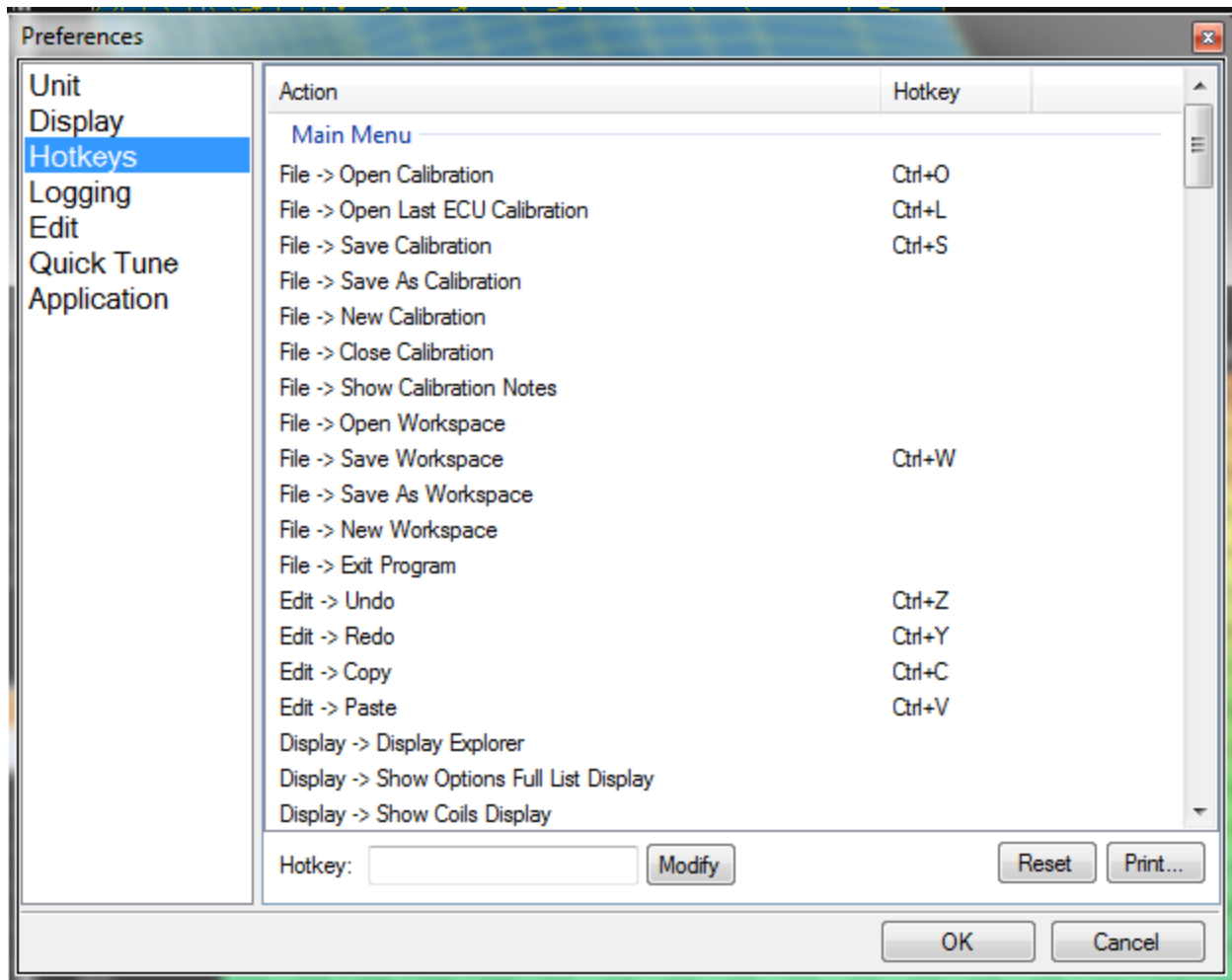

Hotkey Preferences

Hotkeys are time saving tools and are extremely useful. The Hotkeys preference dialog allows the user to have complete control over the Hotkeys defined for almost any action. Many standard Hotkeys are pre-defined. All can be modified by the user. To add a new Hotkey to one of the action items in the list or to modify an existing Hotkey, highlight the action item then type the preferred Hotkey into the box below:

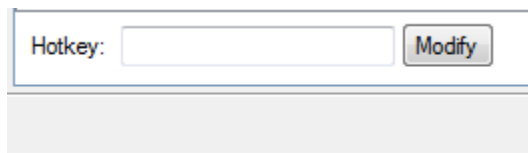

Hotkey Detail

To define a Hotkey using the *Control + I* combination, click inside the Hotkey box and type *Control + I* then click the Modify button to activate the change.

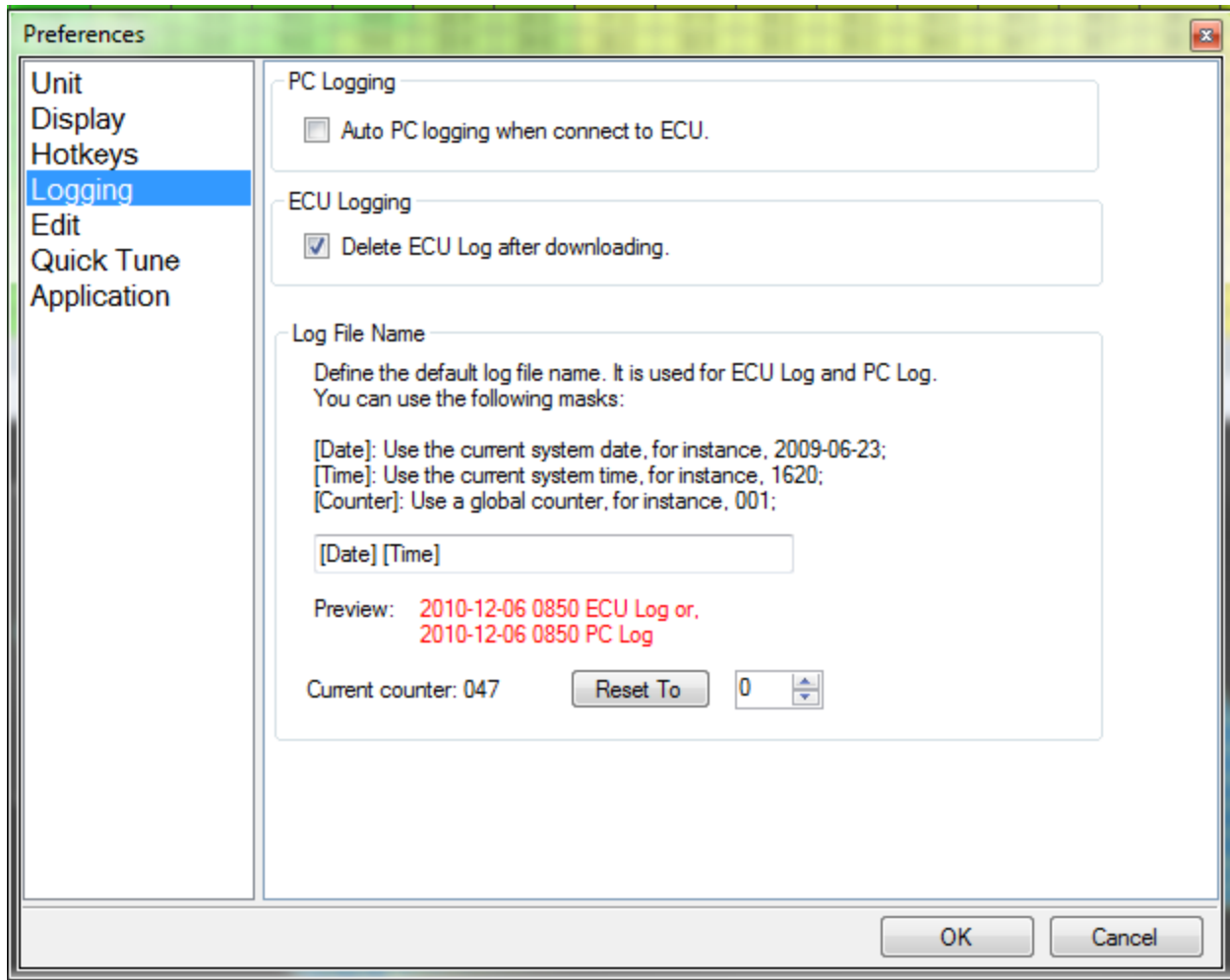

Logging Preferences

There are two types of logging, Internal Logging and PC Logging. The system can be configured to always log to the PC when the PC is connected to the EMS by selecting the first checkbox in the window above. The second checkbox allows the user to always delete the log file saved internally to the EMS after downloading. Otherwise, a copy is downloaded and the original is retained in EMS memory. Standard log file names for both types of logging can also be configured in this window.

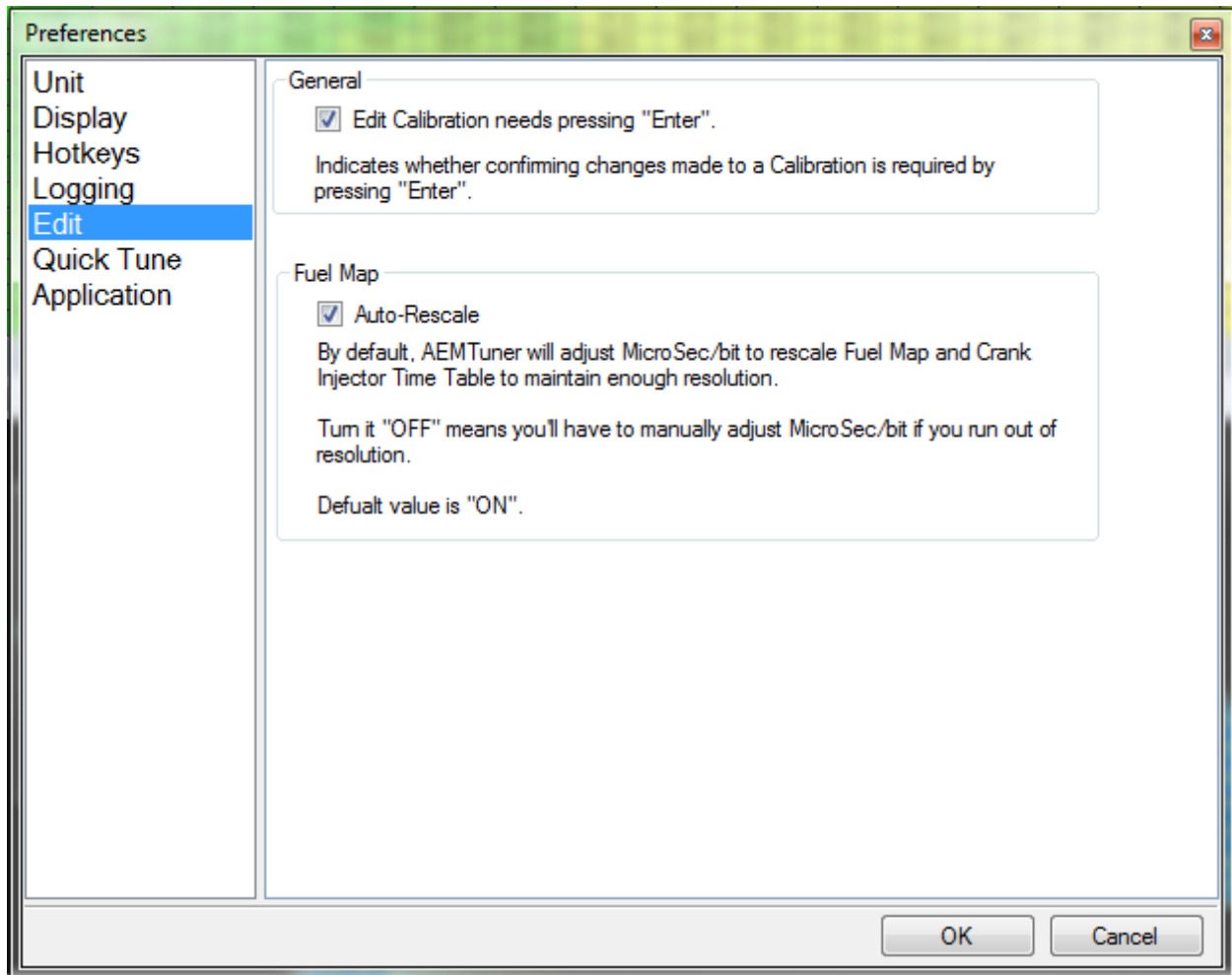

Calibration Edit Preferences

When the first checkbox in the window above is selected, the ENTER key must always be pressed to confirm calibrations changes. This is the default configuration.

The Auto-Rescale selection allows AEM Tuner to continuously optimize the resolution in the main fuel map and crank injector time table. Default setting for this selection is ON.

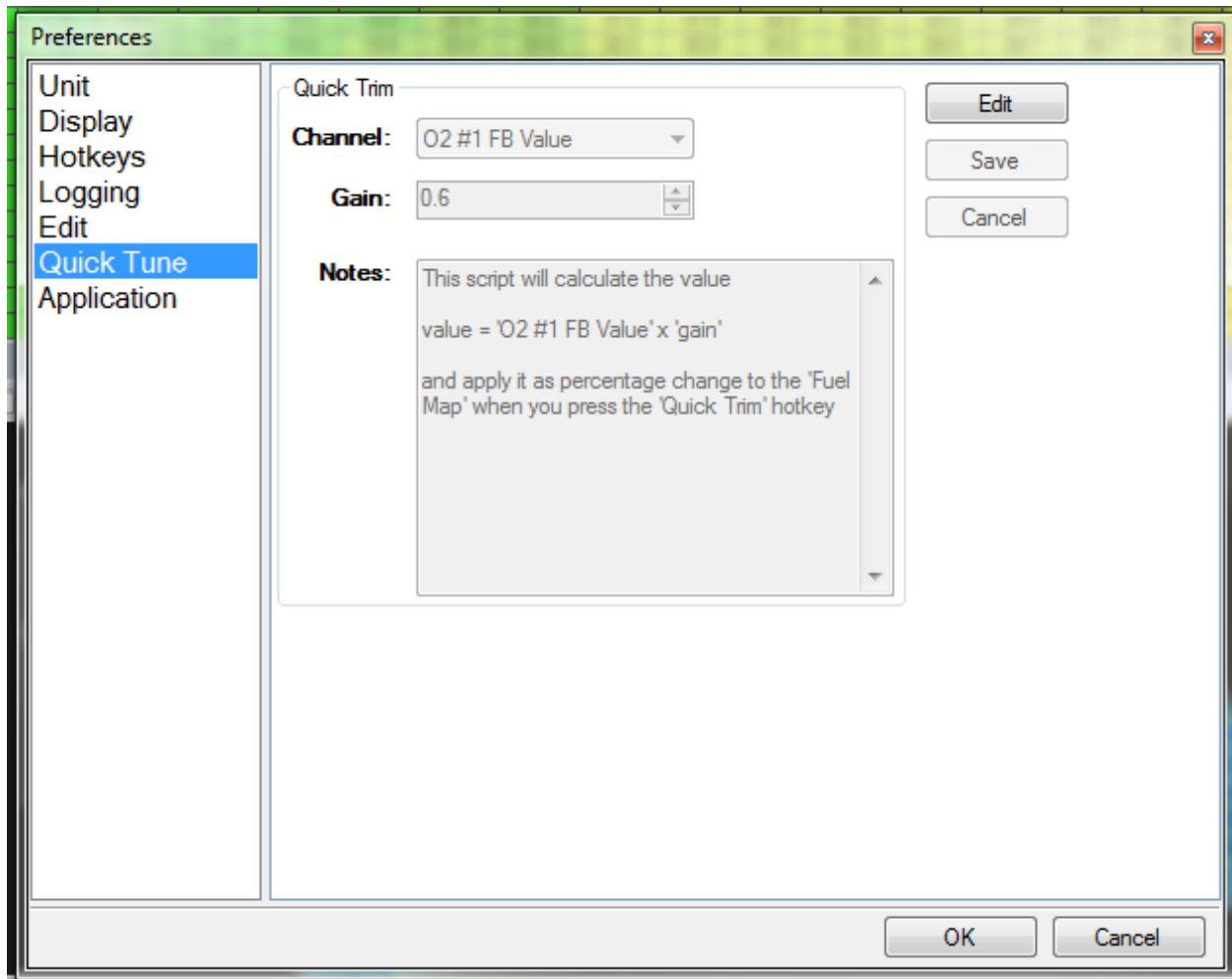

Quick Tune Preferences

The quick tune feature allows AEM Tuner to automatically calculate main fuel map changes necessary to minimize the O2 correction value.

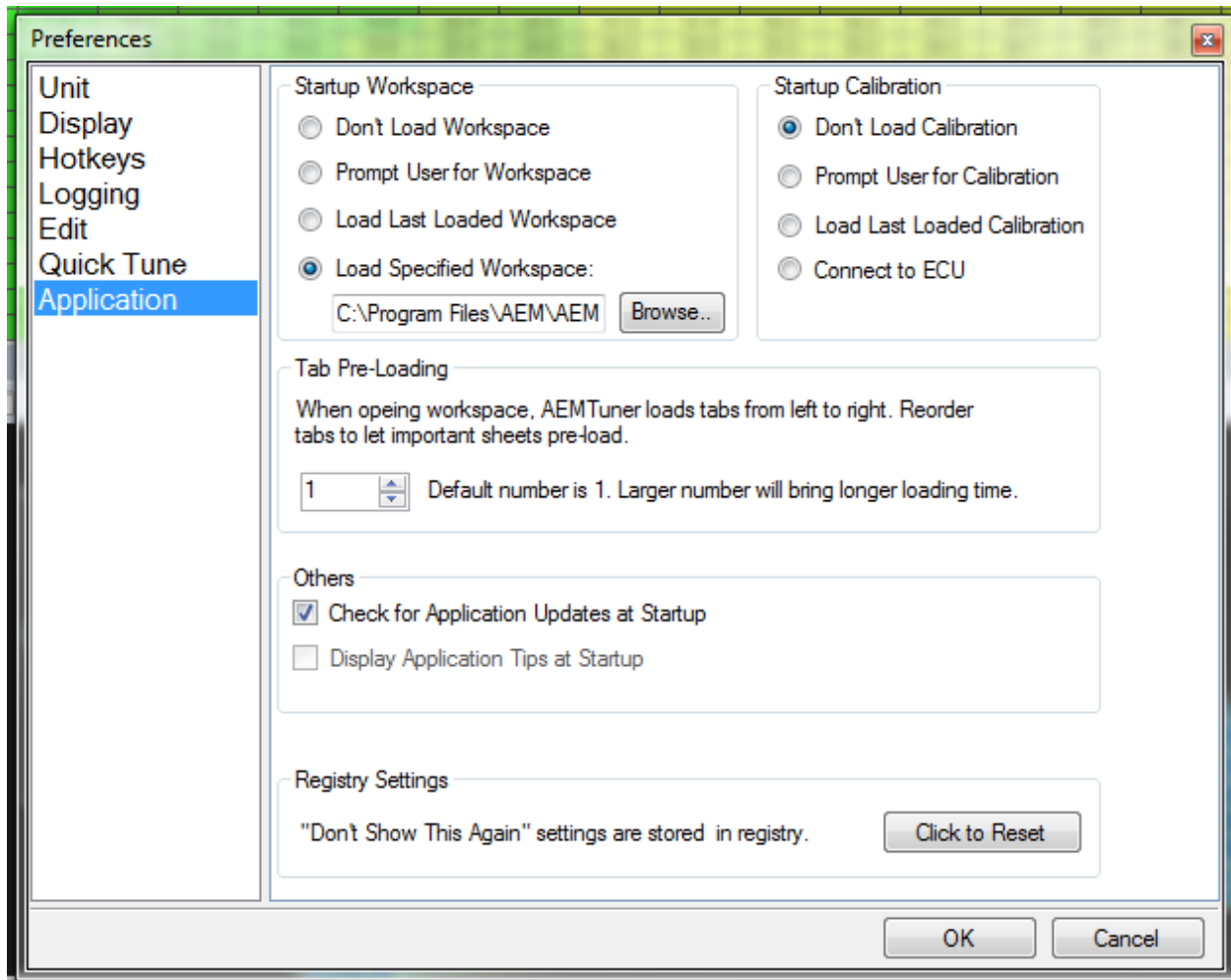

Application Preferences

The application preferences dialog controls settings related to Workspace, Calibration Files and Tabs loading. It also allows the user to enable or disable the application updates feature. When the Check for Application Updates at Startup is selected, AEM Tuner will connect to the internet and notify the user of software or calibration file updates from AEM.

WIZARDS

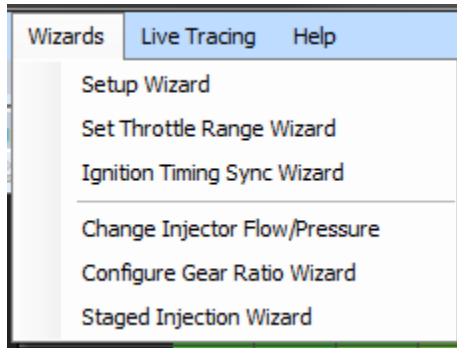

Wizards Menu Item

Setup Wizard – Contains pre-defined options, tables and maps to configure a calibration file for a certain purpose. Applying a Setup Wizard modifies the currently opened calibration file. Setup Wizards can be used to apply the proper battery offsets for fuel injectors or select the proper settings for a certain manifold pressure, air temperature or coolant temperature sensor. AEM is constantly adding to the list of available Setup Wizards for each EMS type.

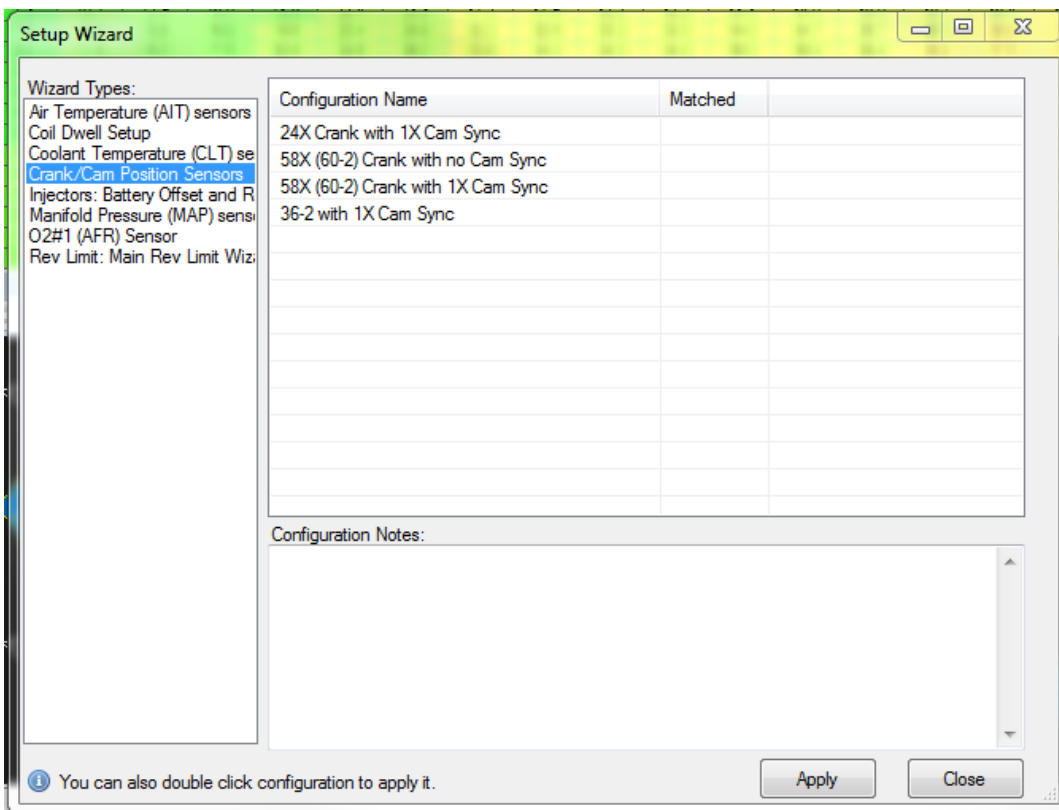

Setup Wizards

To use a Setup Wizard, select a Wizard type then either double click on the desired settings or click once and hit the Apply button.

In addition to the generic Setup Wizard shown above, there are several specific Wizards used to accomplish certain tasks.

Set Throttle Range Wizard – The useable range for the TPS sensor must be defined in the calibration file accurately. The Set Throttle Range Wizard automates this process.

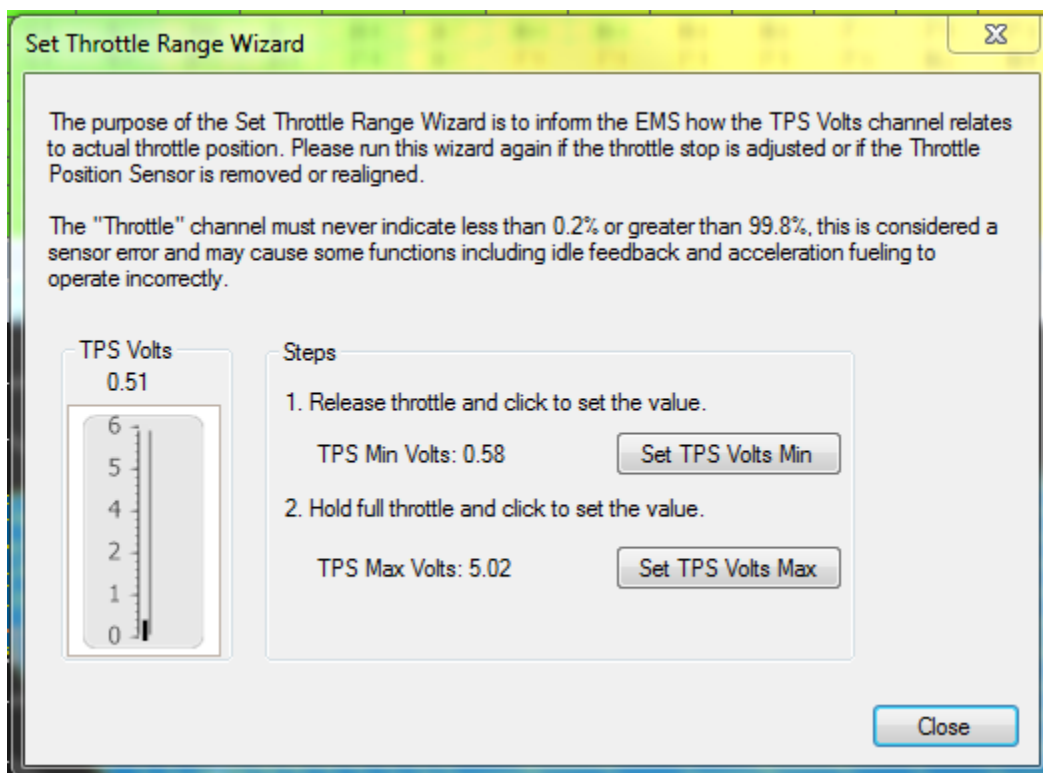

Set Throttle Range Wizard

The PC must be connected to the EMS. With the throttle in the full closed position, monitor the TPS Volts value in the window above. Minimum TPS voltage is usually 0.5 – 1.0 volts. Click the Set TPS Volts Min button. Next push the throttle to the wide open position. Monitor the TPS Volts value. Maximum TPS voltage is usually 4.0 to 4.5 volts. With the throttle held open, Push the Set TPS Volts Max button. Close the window. The throttle is now calibrated.

Ignition Timing Sync Wizard – The purpose of the Timing Sync Wizard is to synchronize the actual ignition timing with the value commanded by the EMS.

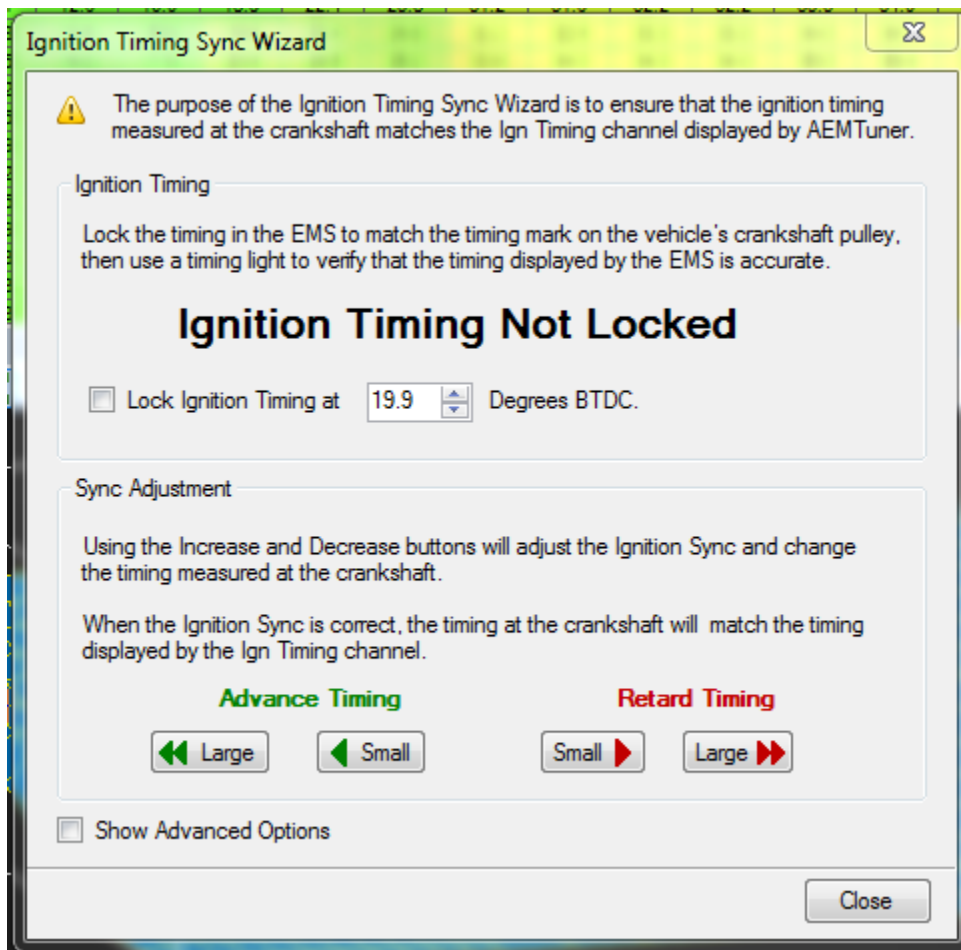

Ignition Timing Sync Wizard

The PC must be connected to the EMS and the engine must be running. To minimize ignition timing fluctuation, the timing from the EMS can be locked at a given setting. Select or type in a value then click the *Lock Ignition Timing at* checkbox. Next measure the ignition timing at the balancer with a timing light and compare the actual reading to the commanded "locked" value. If they differ, use the Advance or Retard Timing buttons to adjust the actual value until it matches the locked timing value.

Change Injector/Pressure Wizard – If the fuel pressure setpoint is adjusted or if different size injectors are installed on an engine that was previously tuned, the injector/pressure wizard can be used to automatically compensate for this change.

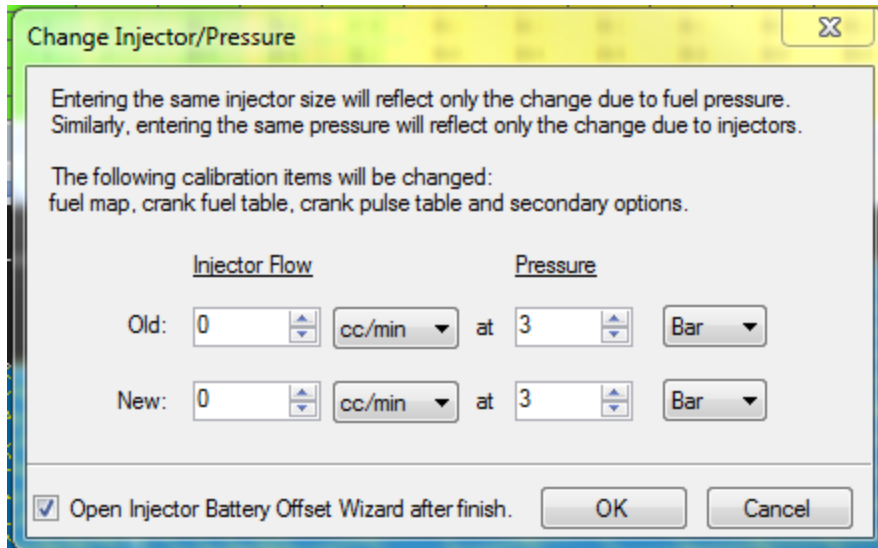

Change Injector/Pressure Wizard

Enter the original (old) injector size and pressure setting and the new settings. AEM Tuner will automatically adjust the calibration to account for these changes.

Configure Gear Ratio Wizard – The gear ratio can be calculated based on a ratio of engine speed to vehicle speed. Once the gear ratio is calculated, the data can be used to define a gear position table based on calculated gear ratio. This wizard automates the process.

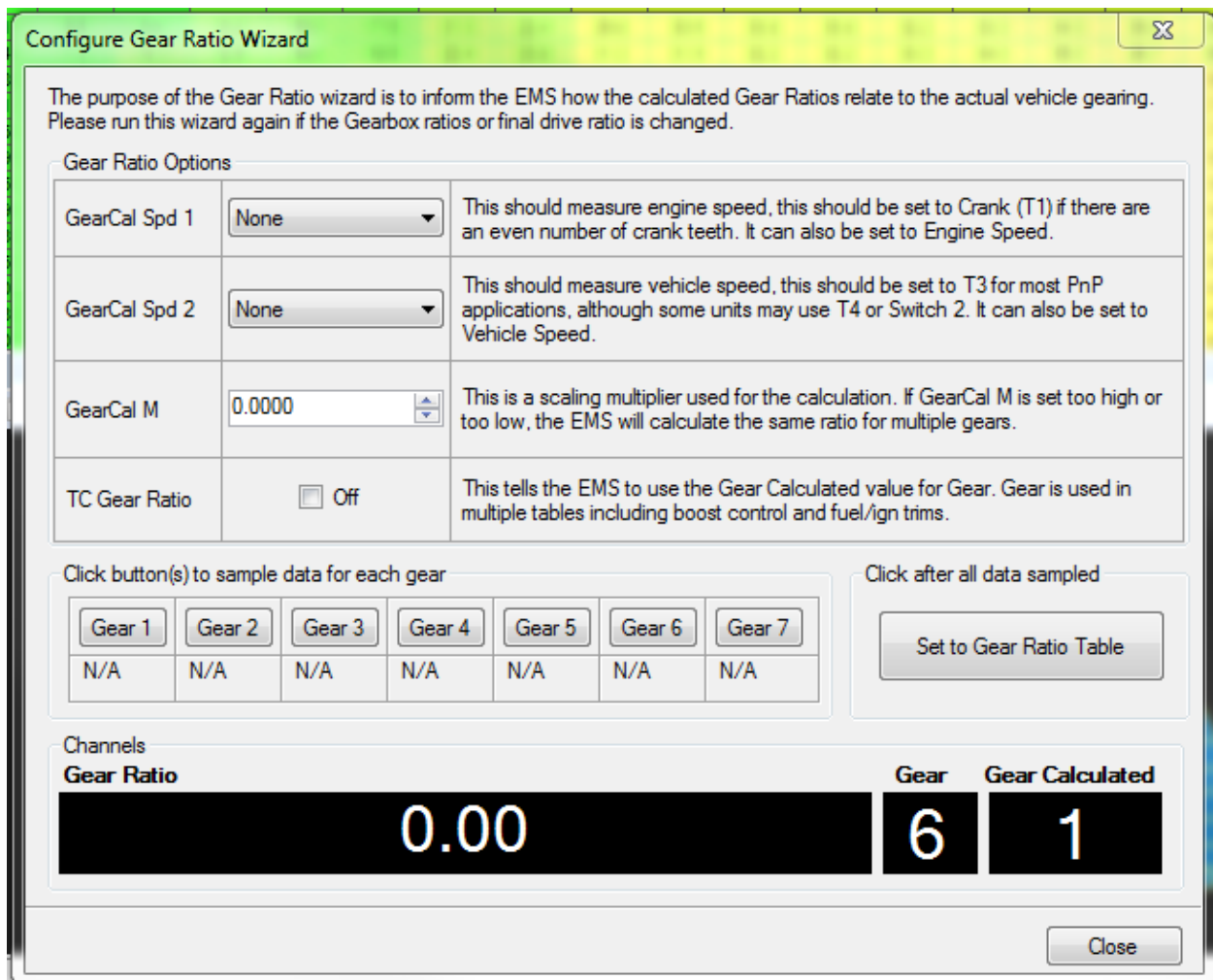

Configure Gear Ratio Wizard

The EMS must be powered up and the PC must be connected. **WARNING!** This procedure should be completed on a chassis dynamometer to ensure safety. The driven wheels must be rotating to generate a suitable vehicle speed signal. Follow the on-screen instructions. Select Engine Speed for GearCal Spd 1 and Vehicle Speed for GearCal Spd 2. Note that certain plug and play applications may have different settings but these will be pre-configured in the base calibration. While driving in each gear, click the Gear 1 – 7 buttons to sample data. When all gears are sampled, click the Set to Gear Ratio Table button to finalize the process.

Staged Injection Wizard – This wizard is used to determine the flow ratio between the primary and secondary injectors and to account for differences in fuel type, fuel pressure or number of injectors.

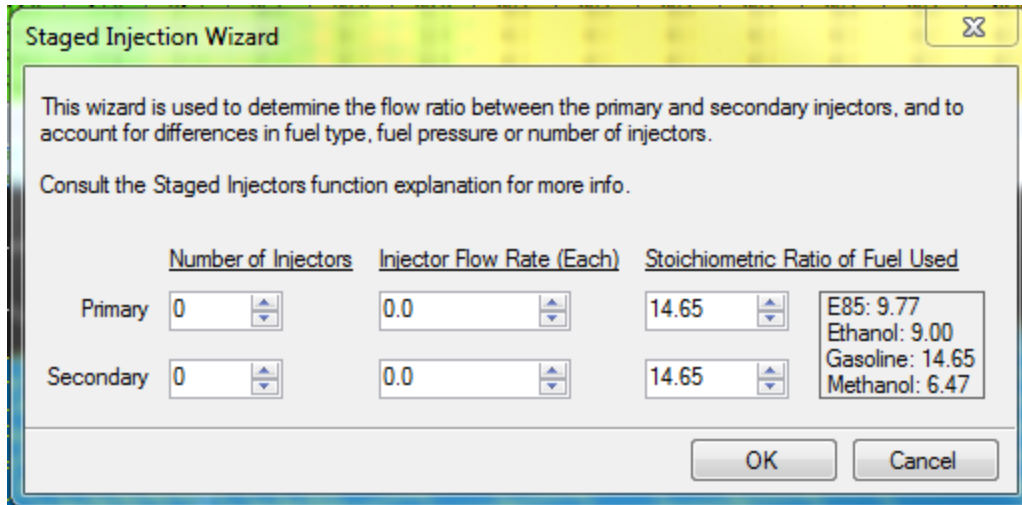

To use the wizard, enter the number of primary and secondary injectors, the flow rate of each (as measured in the same units) and the stoichiometric ratio of the fuel used for each. Click the OK button to complete the process.

Note that there are still certain settings necessary to completely define a staged injection setup. These will be covered later in this manual.

LIVE TRACING

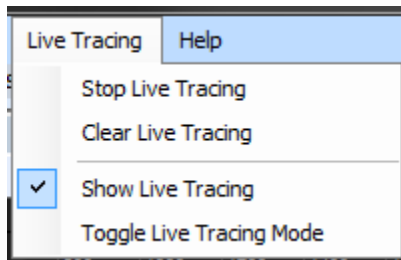

Live Tracing Menu

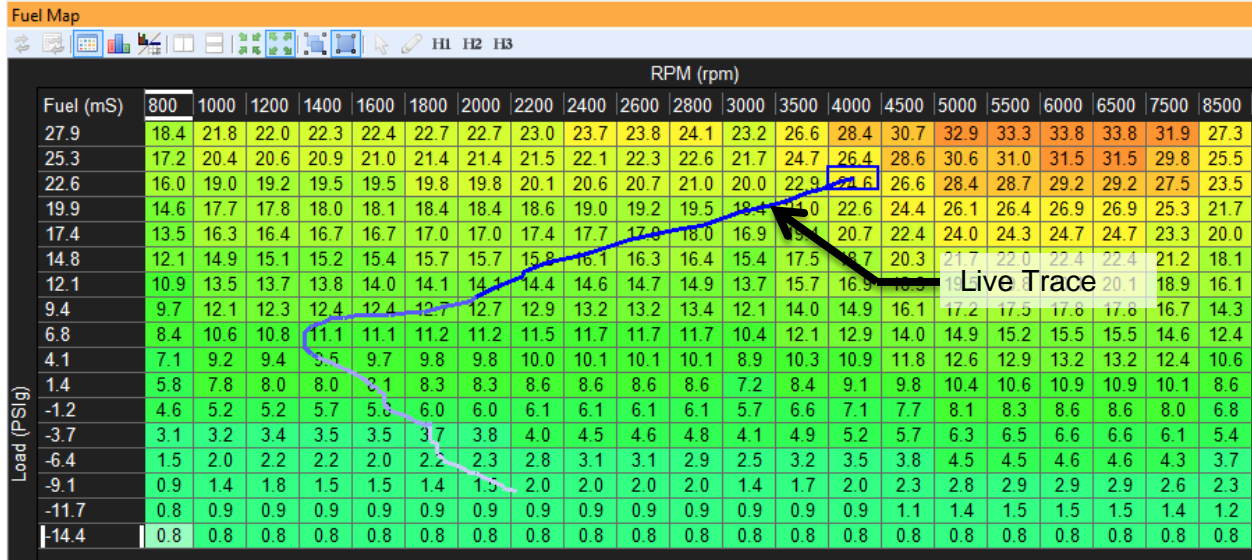

Main Fuel Map showing Live Tracing

The Live Trace features displays a brief “history” of where the EMS has been accessing tuning data from a map.

Stop Live Tracing – Stops Live Tracing if currently running.

Clear Live Tracing – Clears the current Live Trace saved in Memory.

Show Live Tracing – Displays the currently saved Live Trace.

Toggle Live Tracing Mode – Toggles between the two available Live Tracing modes, auto fading with trail length or no fading. See also Tools – Preferences – Display.

HELP

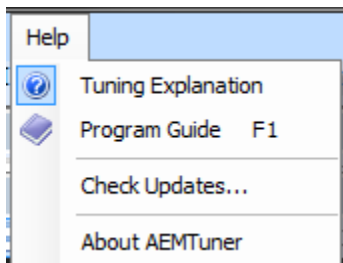

Help Menu

Tuning Explanation – Toggles On/Off the Item Explanation pane on the right hand side of the AEM Tuner window.

Program Guide – Opens the on-line help file.

Check Updates – If connected to the internet, AEM Tuner will contact the AEM servers and download any available software or calibration file updates.

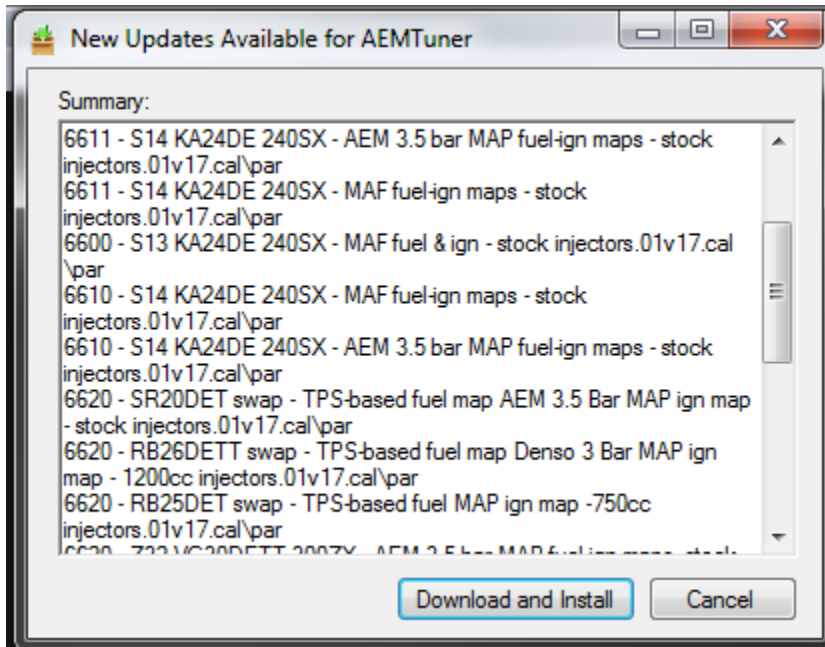

AEM Tuner Updates Feature

Click the Download and Install button to save the files. Calibration file updates are automatically saved in the AEM Updates folder as shown below:

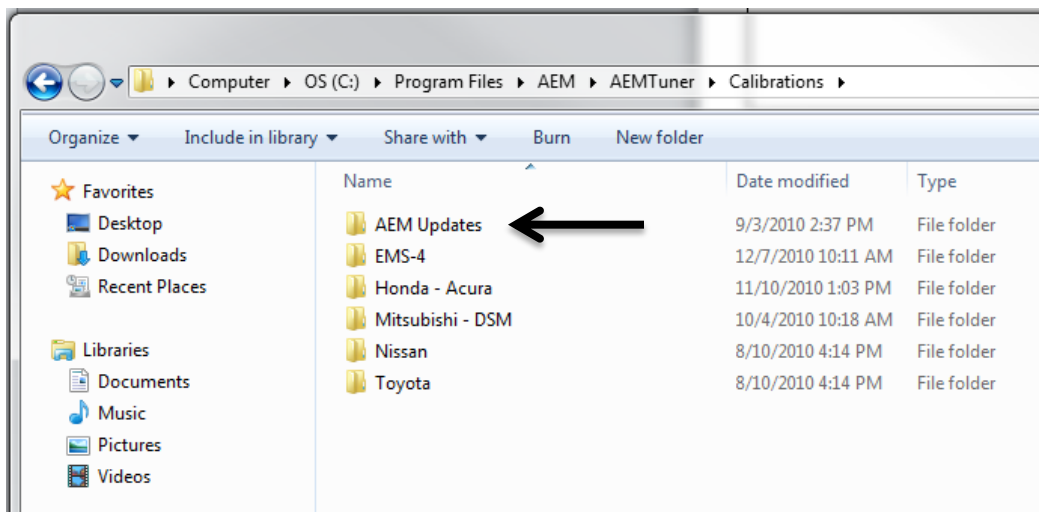

About AEM Tuner – Displays the installed version and build date:



Editing EMS Calibration Files

Editing Options Displays

Options can be any of the following:

1. Single numeric values like *Fuel Pump Prime* time in seconds
2. On/Off selections to enable or disable calibration features
3. Drop down list selections to assign an input pin or output pin for use in a calibration feature or function.

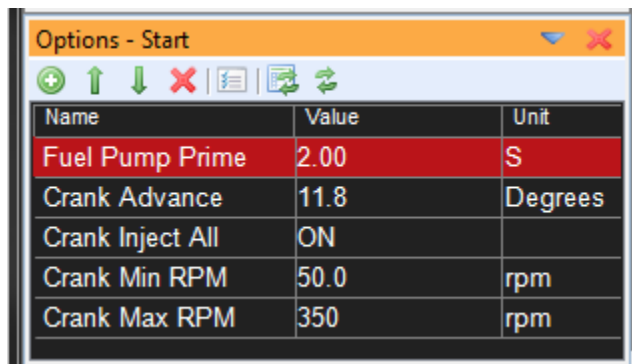



Options Display Toolbar Icon Function

 Show or hide the icon toolbar

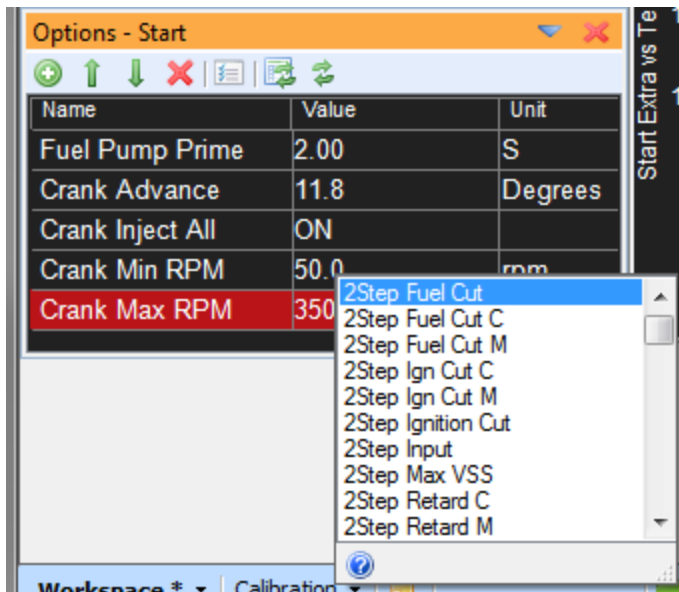
 Quick insert new option



Choose new option from drop down list. Option will be inserted after highlighted row.

  Move selected option row up or down within the display window.

 Removes currently selected option from display.

 Change display contents. Opens separate window below:

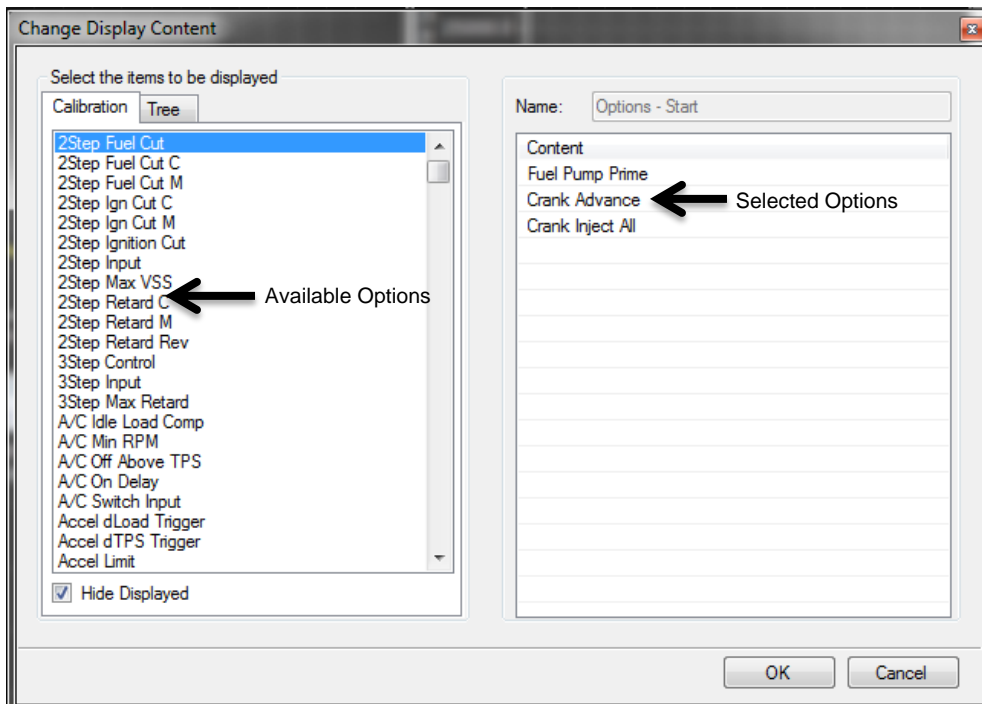

Select options from the left side then click OK to add them to the display. Options can also be selected from a “Tree” type view by clicking on the Tree tab above.

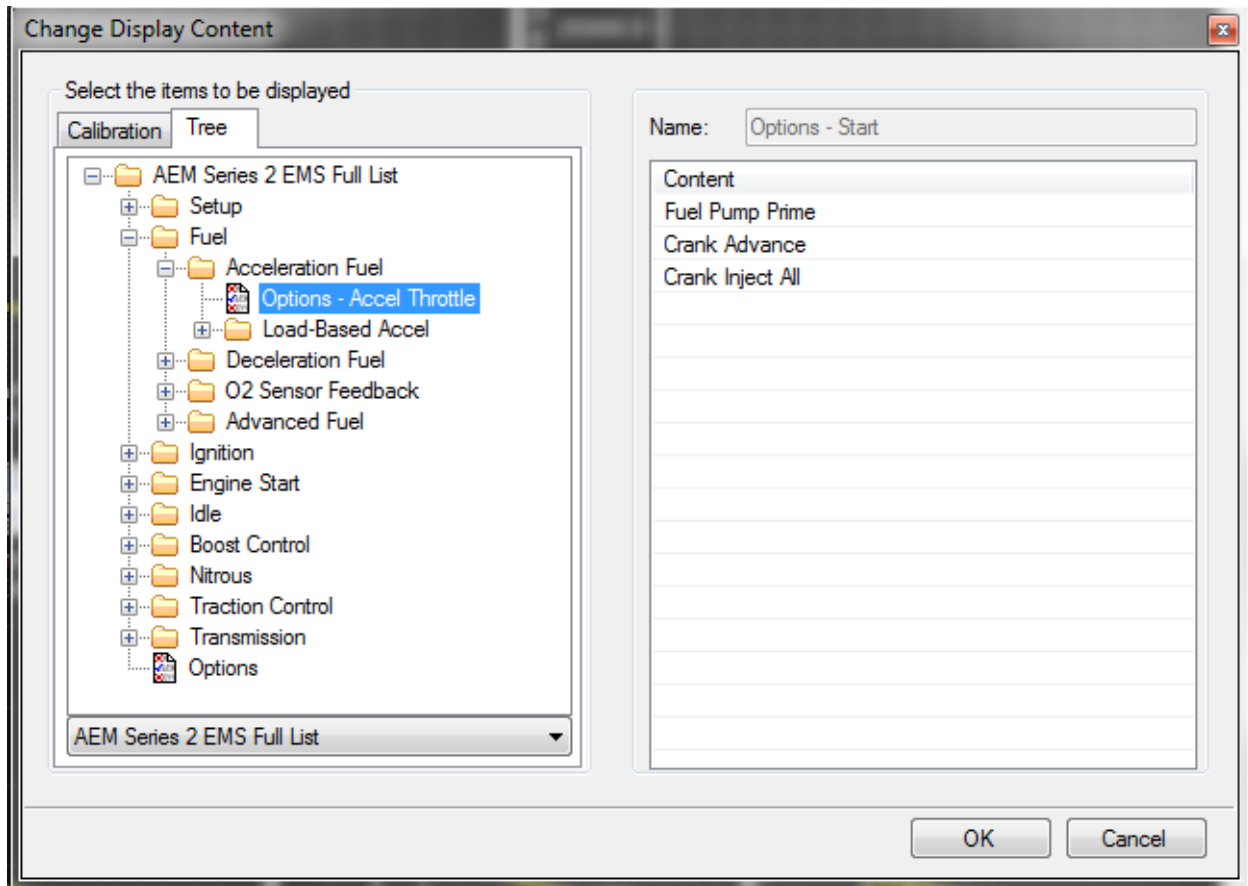

 Reset selected modification states. For any currently highlighted option row, clicking this button will reset the state of the selected option.

 Reset all states. Resets all modification states within the option window.

Options Display – Right Click Menu

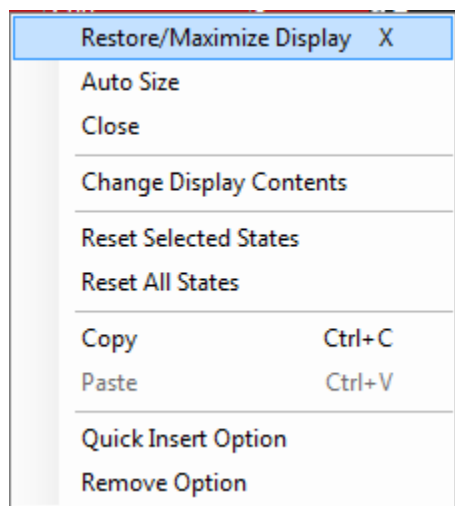

Right clicking within an option display brings up the menu above. Functions are similar to those described above using the toolbar icons.

Editing Options Display Data

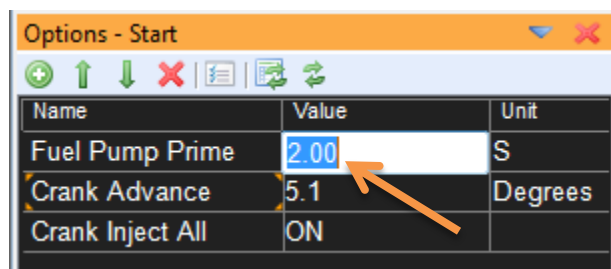

To edit a value within the options display window, first double click on the value until it is highlighted blue as shown above. At this point, function is similar to any standard Windows text box. Edit the value and hit the ENTER key to confirm. Double clicking on some options will open a drop down listing. Note that the ENTER confirmation requirement is a user preference. See Tools – Preferences – Edit for more information.

Crank Advance Changed option values will display a notification around the name indicating the calibration value has changed. This option is in a “modified” state.

Editing 2D Table Displays

A 2D **table** represents a function that equates one value to another. AEM EMS calibrations contain many 2D tables. Examples include sensor calibration tables that equate voltage to temperature, tables that define desired idle speed as a function of coolant temperature, etc.

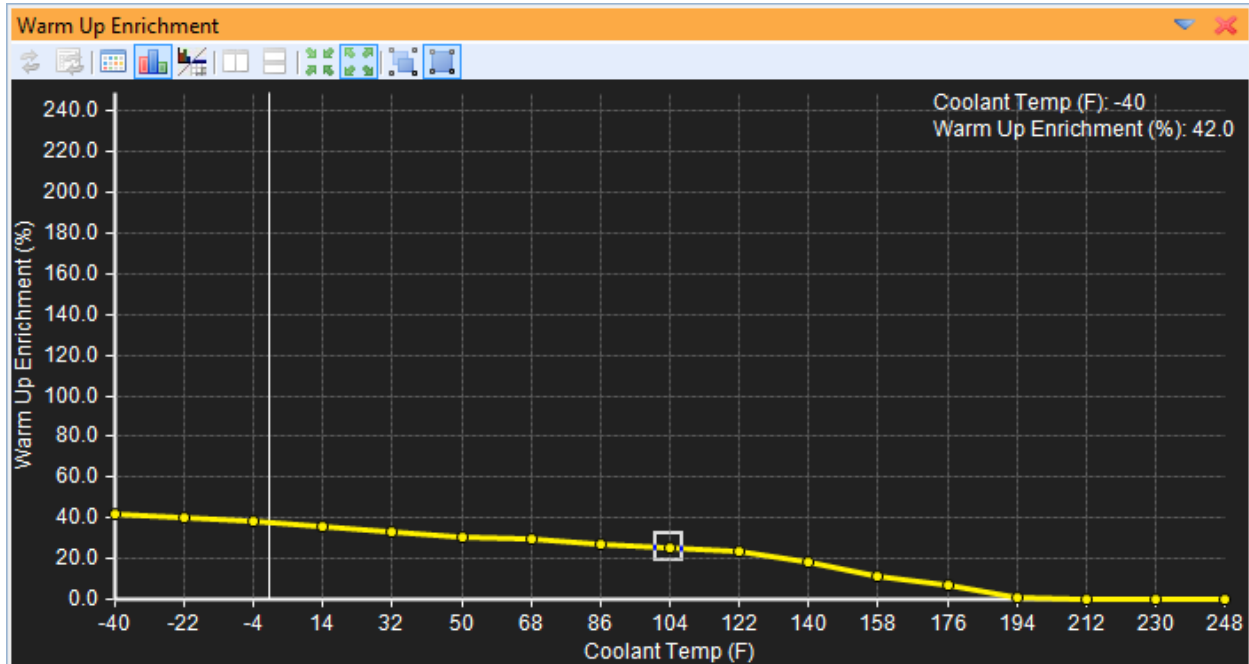





2D table in Graph View mode

Coolant Temp (F)	-40	-22	-4	14	32	50	68	86	104	122	140	158	176	194	212	230	248
Warm Up Enrichment	83.0	77.1	71.3	68.4	61.5	55.7	48.8	41.0	35.2	27.3	17.6	11.7	6.8	1.0	0.0	0.0	0.0

2D table in Table View mode

Table Display Toolbar Icon Function

-  Show or hide the icon toolbar
-  Close display
-  Reset all states. Resets all modification states within the table window.

 Reset selected modification states. For any currently highlighted cell, clicking this button will reset the modification state of the selected cell.

 Toggles table view mode

 Toggles graph view mode

 Toggles split graph/table mode

 Auto table sizing. Allows table cells and data to expand to fit current window size.

 Font table sizing. Maintains table font size specified in Tools – Preferences – Display – Font.

 Follow ECU. Selected cell or cell group will follow the table cursor while live tuning.

 Manual selection. Selected cells are independent of live cursor position.

Manual Table Editing with +/- keys



To modify table data, left click and drag to select the cells you want to change. Add or subtract from the existing value using the + and – keys. Holding the CNTRL key down will create larger changes.

Table Editing with Right Click Menu

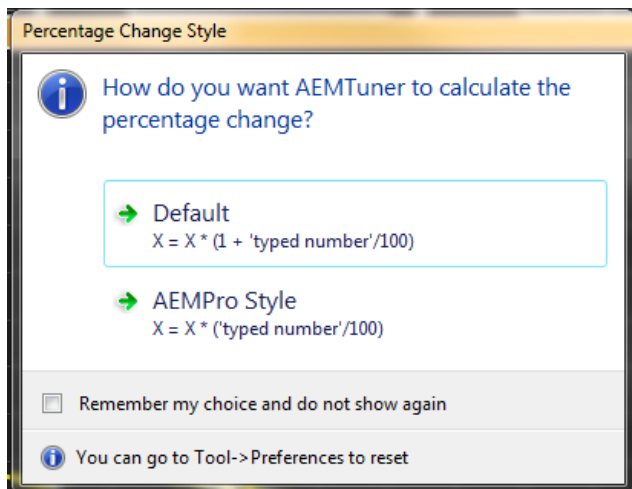
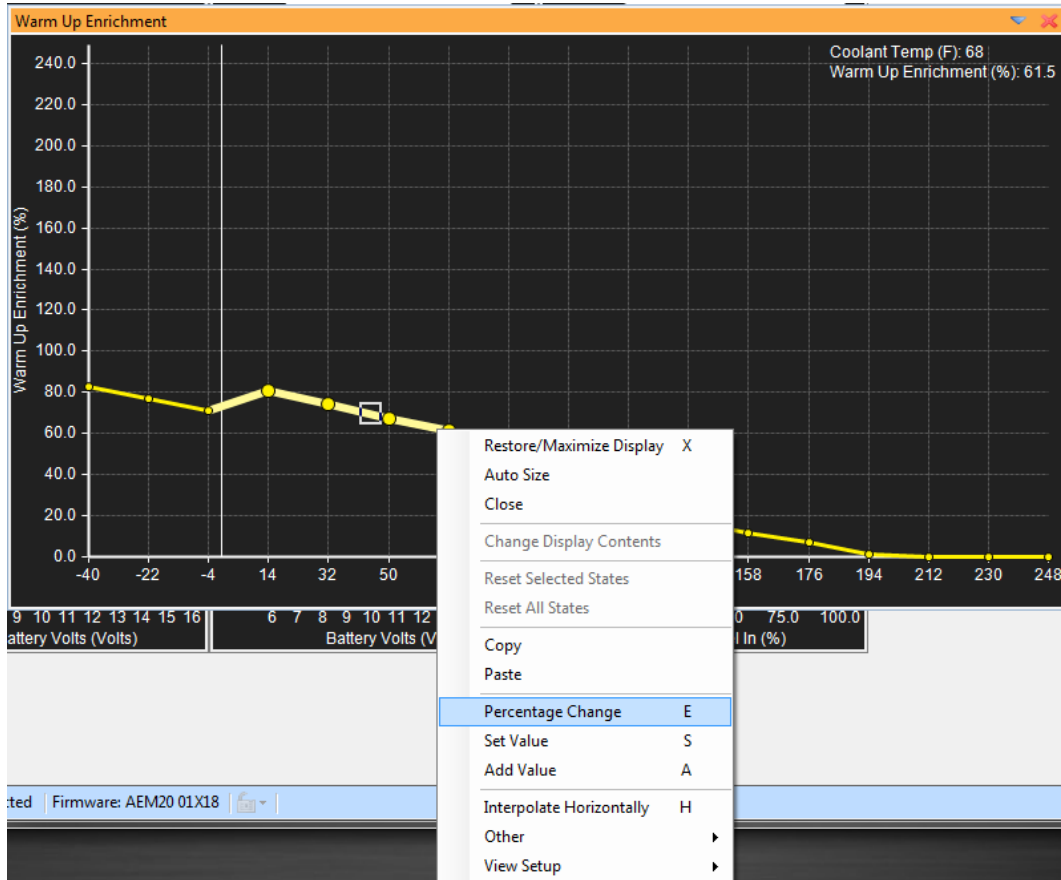

Percent Change – (hotkey E) applies a percentage offset to the value(s). Note that the percentage calculation type is a user preference.

Set Value – Replaces the existing value(s) with the new one entered.

Add Value – Adds an offset to the existing value(s)

Interpolate Horizontally - Uses the first and last cells selected in the direction of

interpolation (either horizontal or vertical) to determine a linear slope, then changes the values of all the cells in between so they have the same slope.

Before Interpolation:



Highlighting Cells to Interpolate:

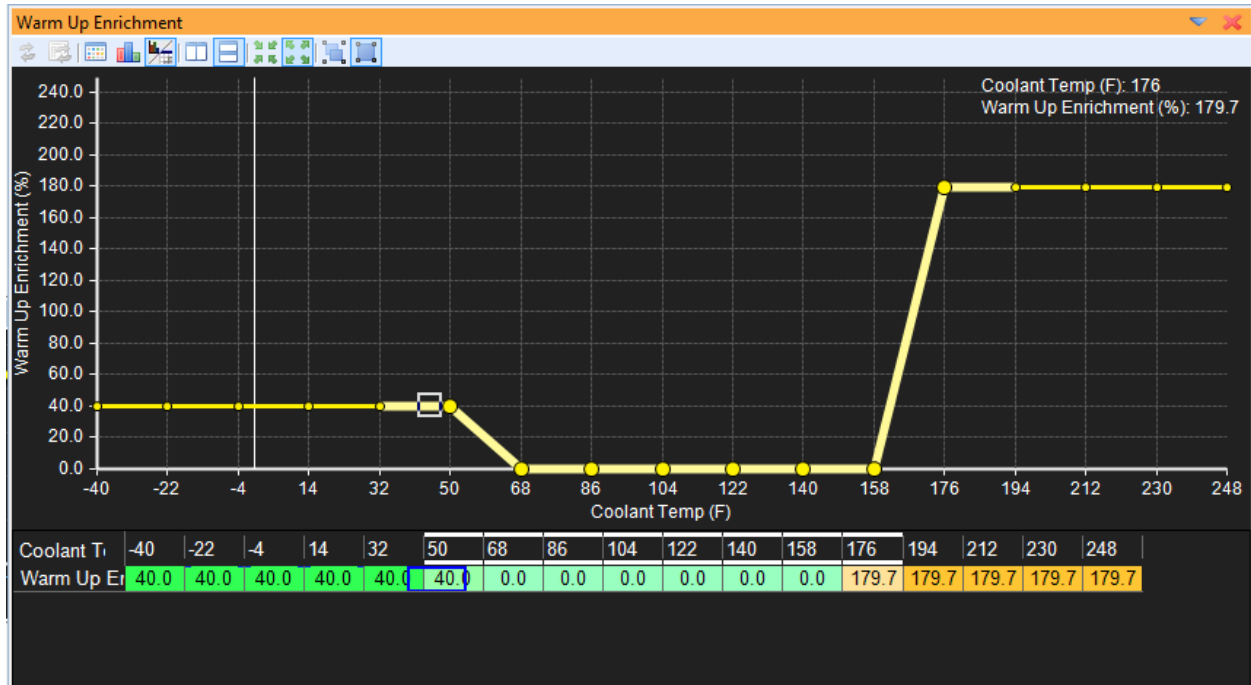

After Interpolation:

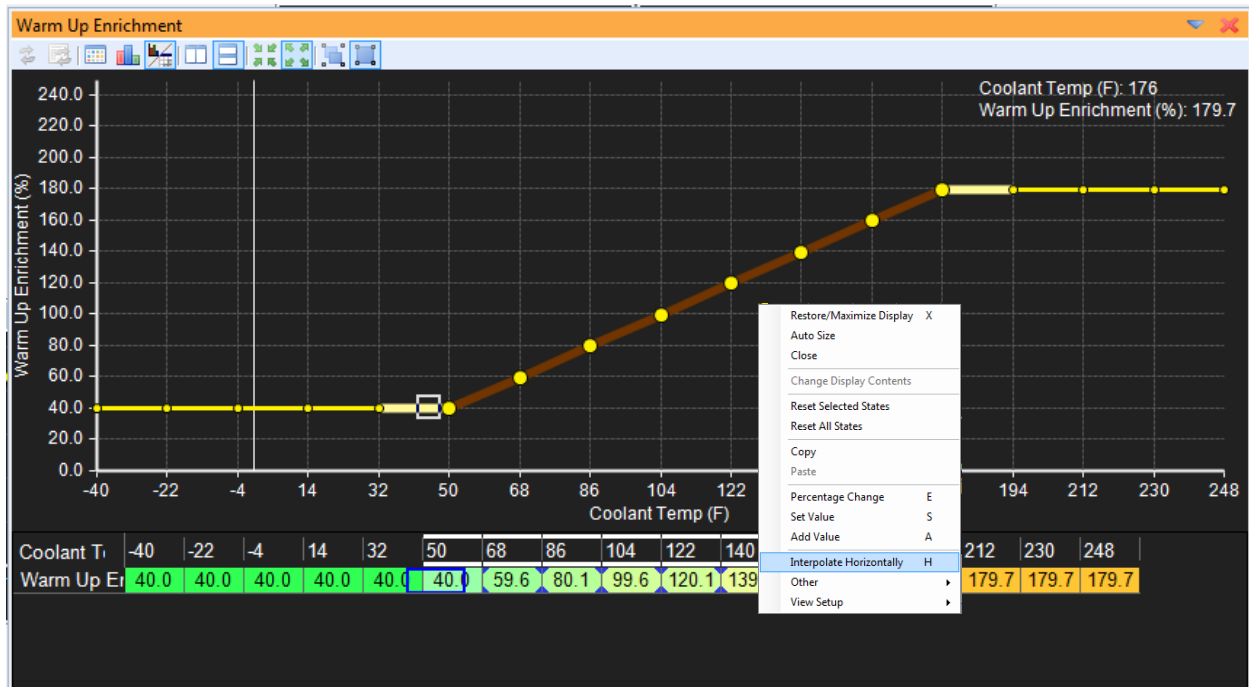

Other Editing Options:

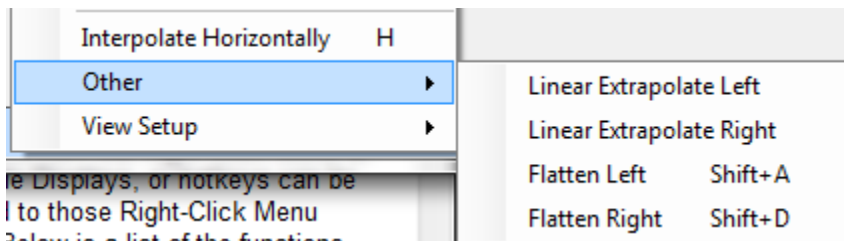

There are four **other** automatic editing options:

Linear Extrapolate (left or right) - Extends the slope of the first two selected cells to the rest of the cells selected in the interpolation direction.

Flatten (left or right) - Allows the user to assign to a group of selected cells the value of the first cell in the flatten direction.

Before Linear Extrapolation:



Selecting Cell Range to Extrapolate:



After Extrapolation:

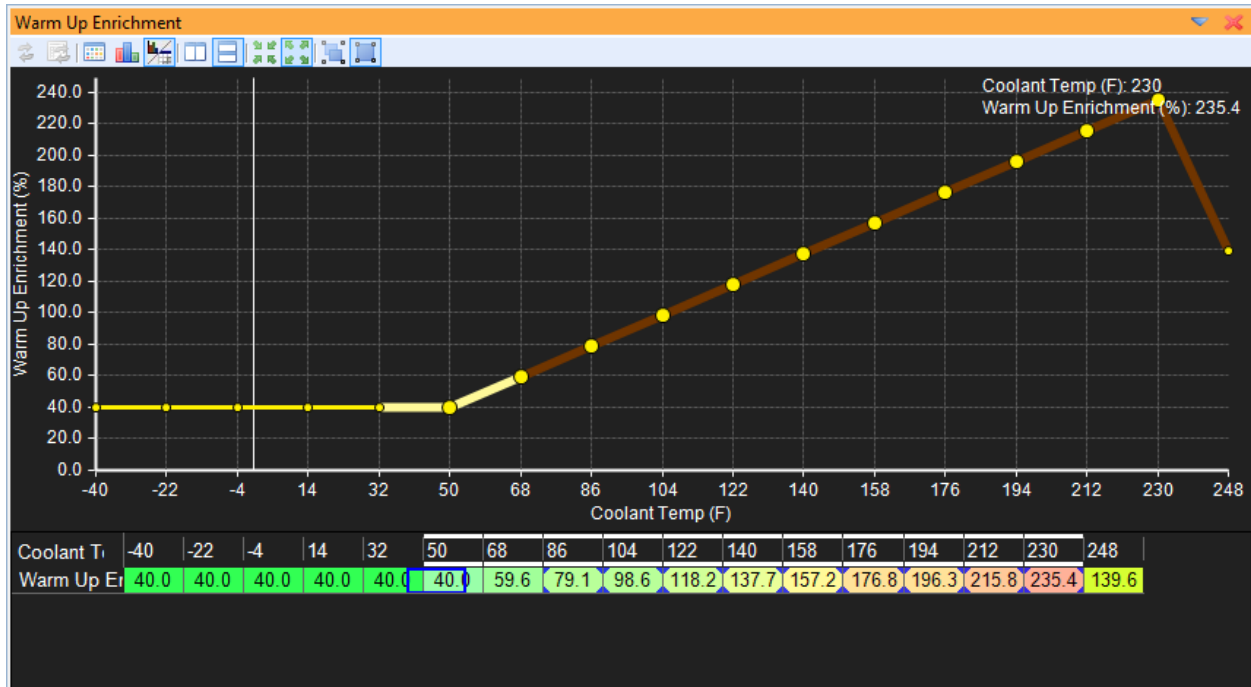

Before Flattening:



Selecting Cells to Flatten:







After Flattening Right:



Editing Channel Displays

Name	Value	Unit
Engine Speed	1409	rpm
Engine Load	5.5	PSI _g
Throttle	0.0	%
Coolant Temp	45.0	F
Air Temp	34.0	F
Ign Timing	16.4	Degrees
O2 Target	14.0	AFR
O2 #1	10.1	AFR
O2 #1 FB Value	0.0	%
Fuel Inj 1 Pulse	15.61	mS
Injector Duty Total	17.9	%
Knock 1 Volts	0.1	Volts
Battery Volts	11.5	Volts
Knock 1 Fuel	0.0	%
Knock 1 Retard	0.0	Degrees
Accel Fuel	0.0	mS
Stat Sync'd	ON	
Timing Errors	1	
Logging	OFF	

Channel Display Toolbar Icon Function

-  Show or hide the icon toolbar
-  Quick insert new channel
-  Move selected channel row up or down within the display window.
-  Removes currently selected channel from display.
-  Change display contents. Opens separate window below:

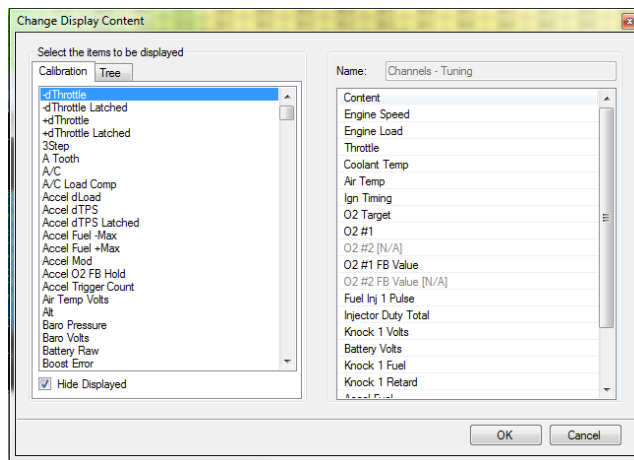

Add or subtract channels by selecting them in left column. Click OK to confirm. Tree view is also available by clicking the Tree tab.

 Configure channel properties. Allows changes to how data is presented in the channel displays.

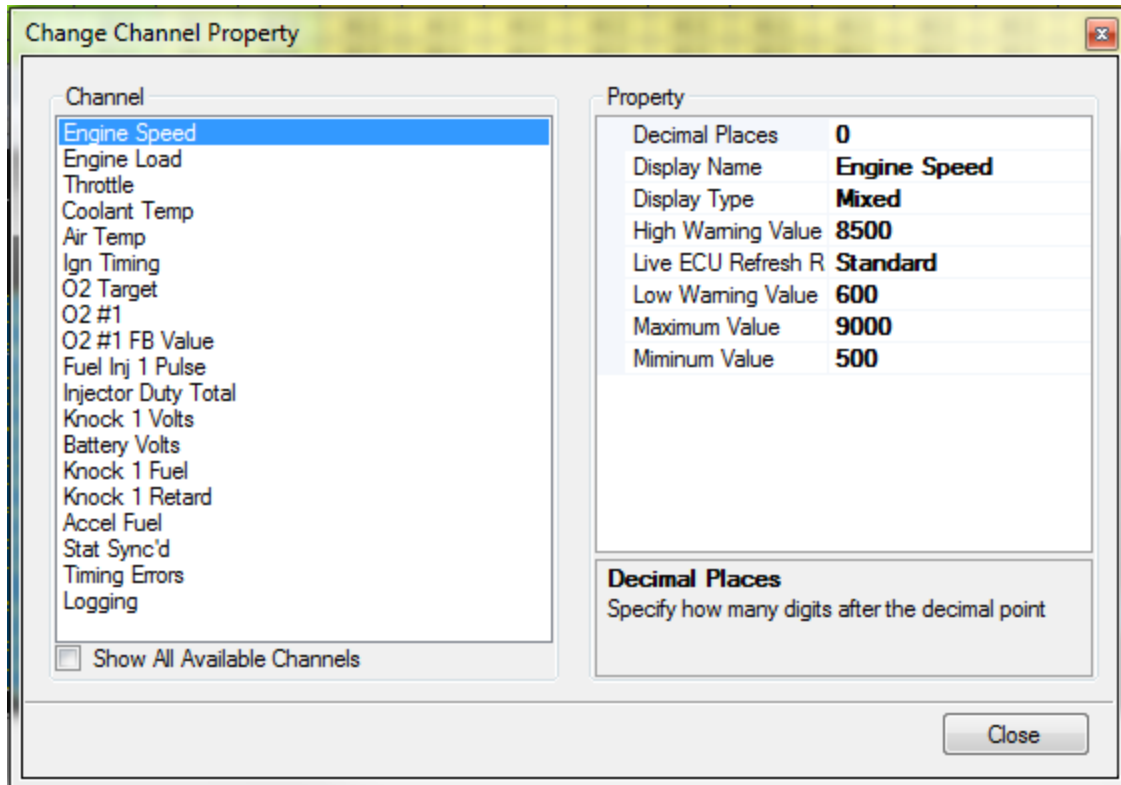

Select the desired channel then click the column next to each property to edit the settings.

Decimal Places – Specifies how many digits after the decimal point

Display Name – Alternative user defined name for the channel

Display Type – How to display the data – numeric value, bar graph or both

High Warning Value – Channel display will turn red when above this value

Live ECU Refresh Rate – Controls how often the channels value is refreshed from the ECU when connected

Low Warning Value – Channel display will turn red when below this value

Maximum Value – The maximum value the channel displays

Minimum Value – The minimum value the channel displays

Editing 3D Map Displays

Table Display Toolbar Icon Function

 Show or hide the icon toolbar

 Close display

 Reset all states. Resets all modification states within the map window.

 Reset selected modification states. For any currently highlighted cell, clicking this button will reset the modification state of the selected cell.

 Toggles table view mode

 Toggles graph view mode

 Toggles split graph/table mode

 Toggles horizontal view orientation. Only available in split graph/table mode





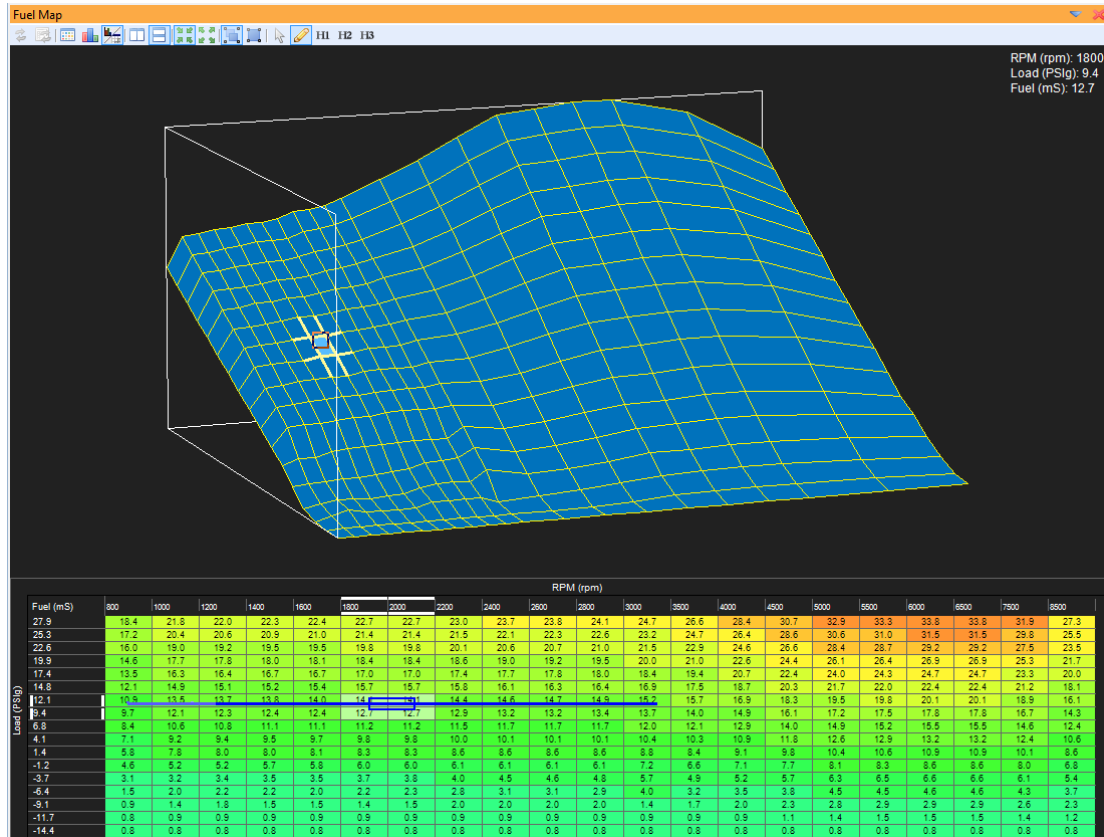

 Toggles vertical view orientation. Only available in split graph/table mode

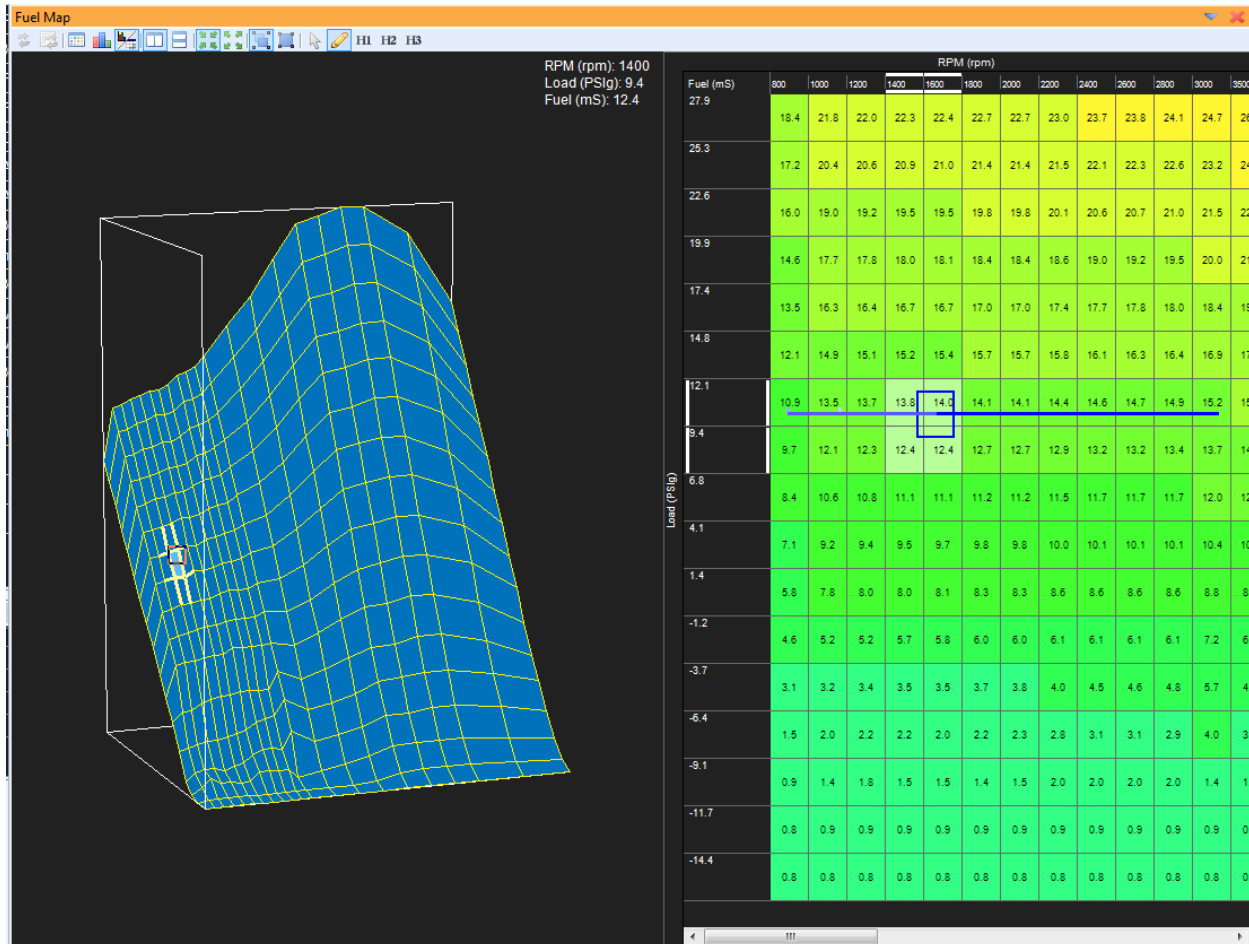
Split graph/table mode (horizontal orientation):



Split graph/table mode (vertical orientation):



-  Auto table sizing. Allows map cells and data to expand to fit current window size.
-  Font table sizing. Maintains map font size specified in Tools – Preferences – Display – Font.
-  Follow ECU. Selected cell or cell group will follow the map cursor while live tuning. With this feature turned on, tune with the +/- keys live and be sure you are editing the exact location used by the ECU.
-  Manual selection. Selected cells are independent of live cursor position.
-  Rotate, Zoom and Pan. When selected, left click and rotate to rotate the graph view. Hold the CNTRL key while left clicking to pan the view.
-  Select and change. When this icon is active, left click and drag to highlight (select) areas of the map to edit.

Highlighted area selected:

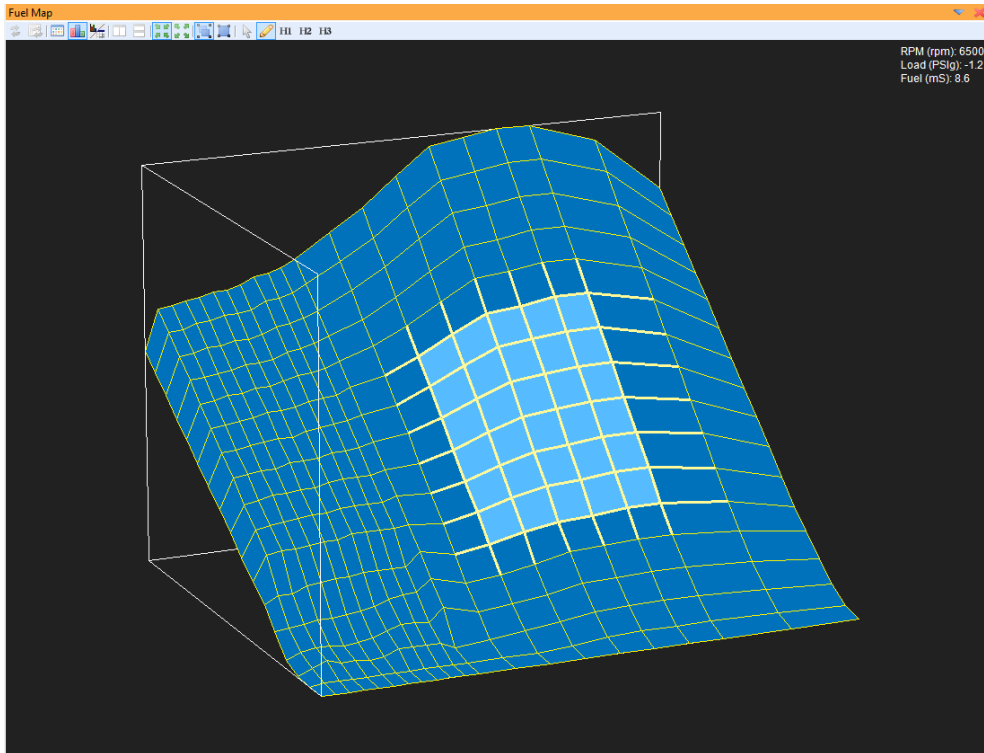

H1 H2 H3 User definable 3D positions. Set map to desired view orientation then right click over each of these buttons to select up to 3 default 3D orientations.

Manual Editing with +/- Keys

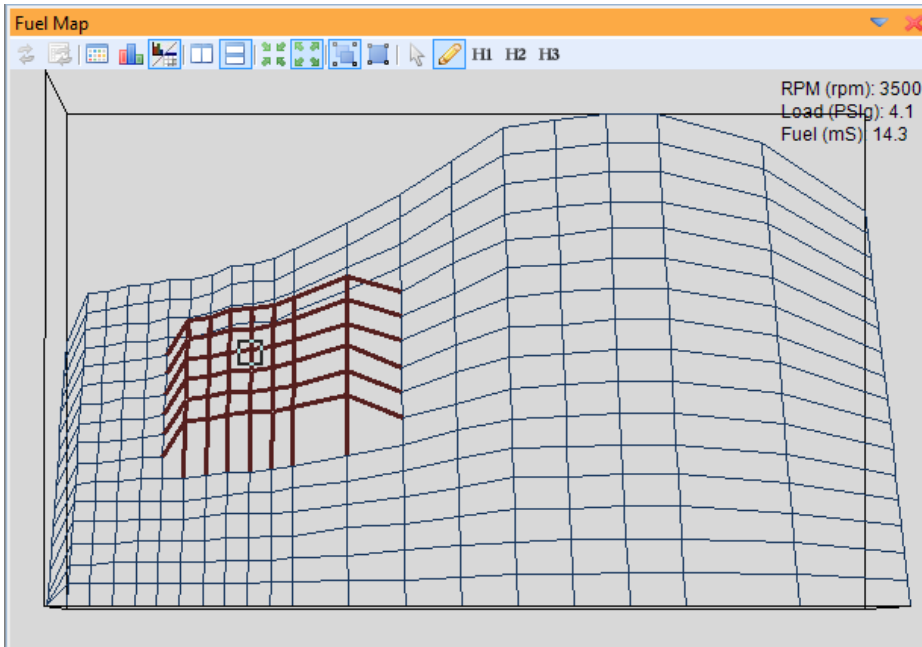

Highlighted area increased using the + key

Note: Display color preferences and orientation changed to illustrate variations

Automatic Editing with Right Click Menu

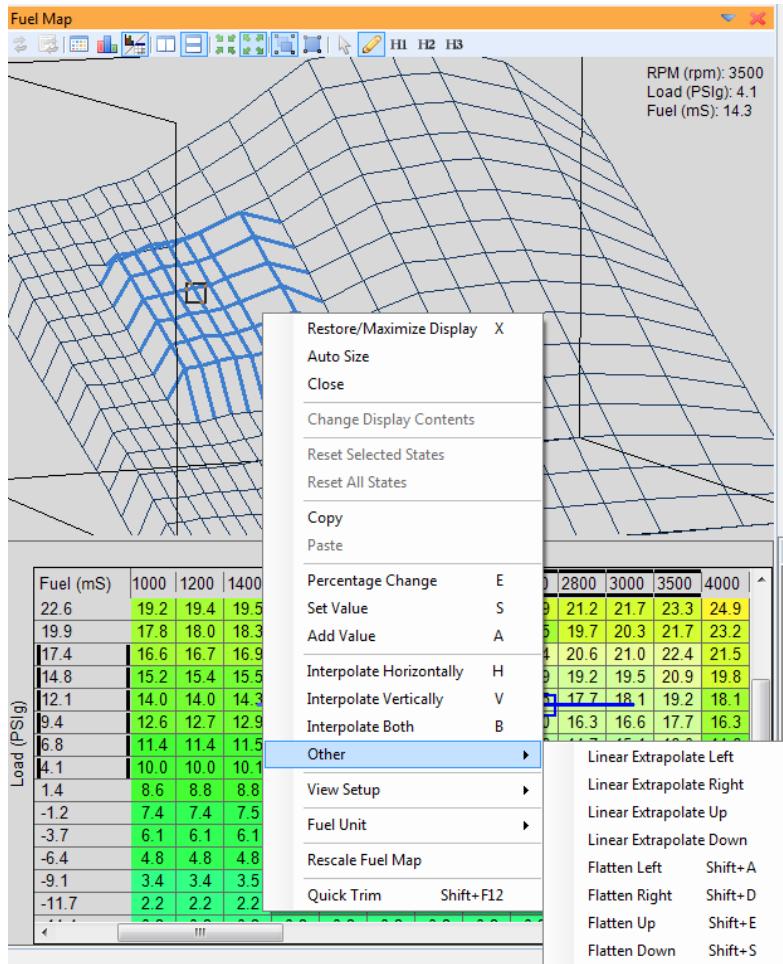

Right click menu editing options for 3D maps are similar to those for the 2D tables but there are more of them.

- Interpolate Horizontally (H hotkey)
- Interpolate Vertically (V Hotkey)
- Interpolate Both (B Hotkey)
- Linear Extrapolate Left
- Linear Extrapolate Right
- Linear Extrapolate Up
- Linear Extrapolate Down
- Flatten Left (Shift-A Hotkey)
- Flatten Right (Shift-D Hotkey)
- Flatten Up (Shift-E Hotkey)
- Flatten Down (Shift-S Hotkey)

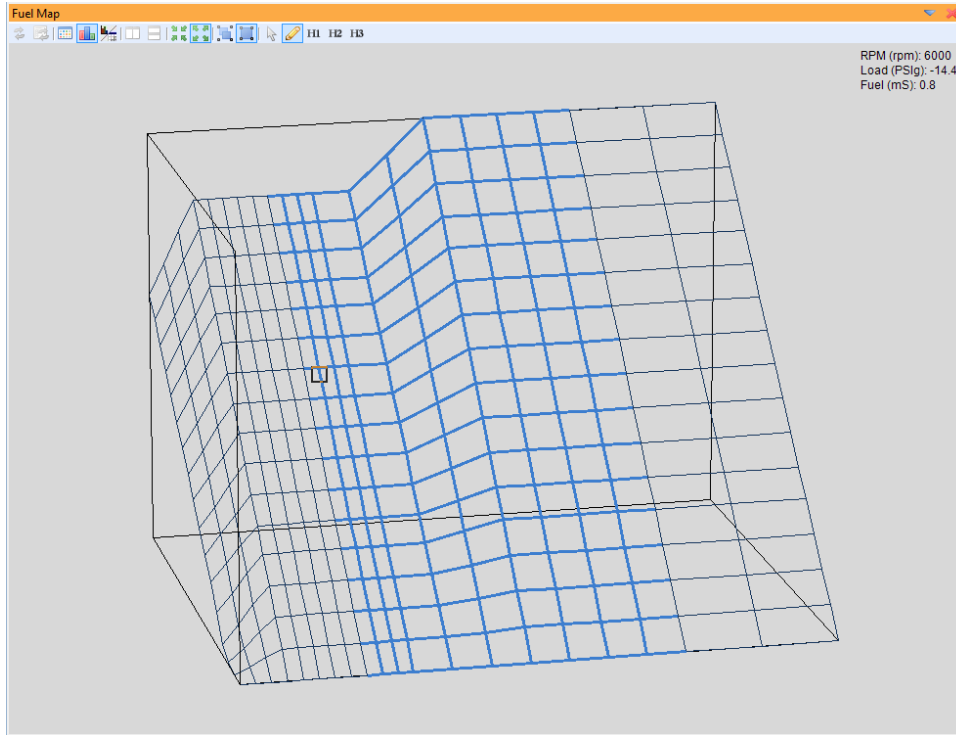

Before **horizontal interpolation**.
Area of interest highlighted.

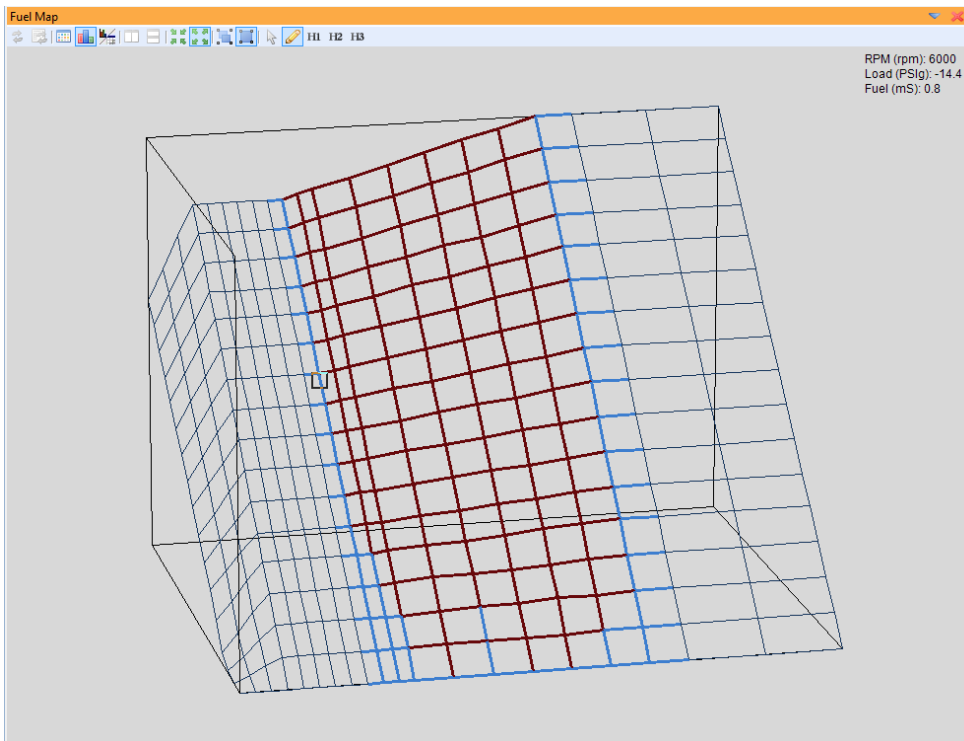

After **horizontal Interpolation**.
Vertical interpolation results similar but in vertical direction.
Interpolate Both will affect both directions

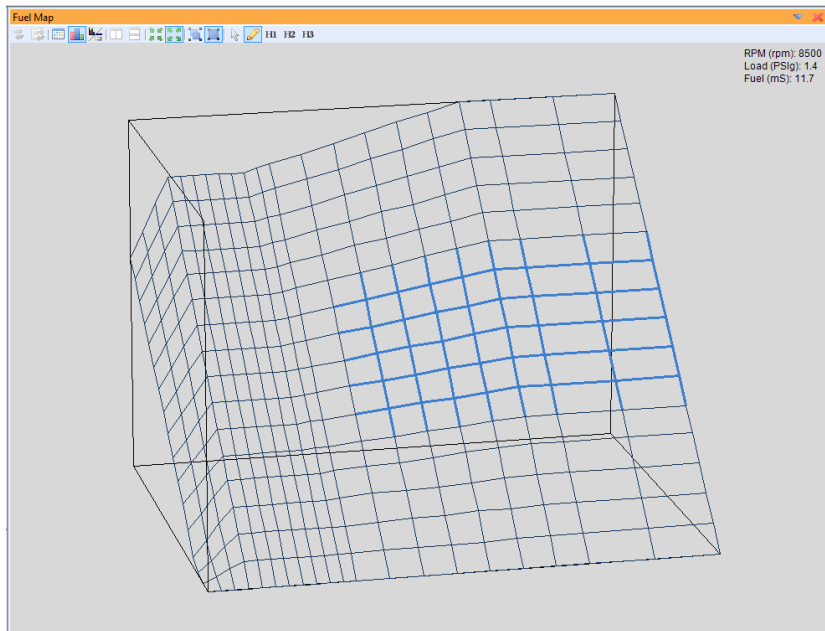

Before **linear extrapolate right**. Area of interest highlighted.

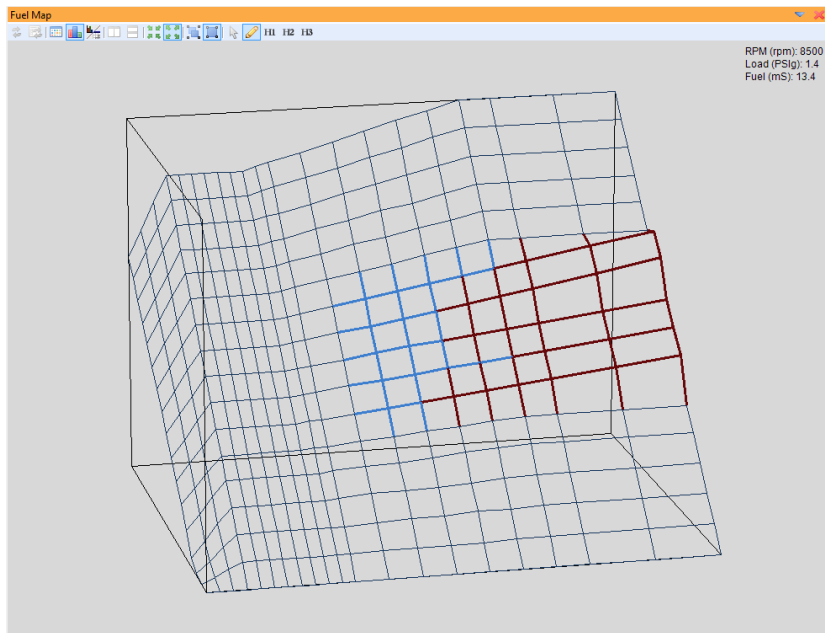

After **linear extrapolate right**. Linear extrapolate left results similar but in opposite direction. Up and down affect also similar.

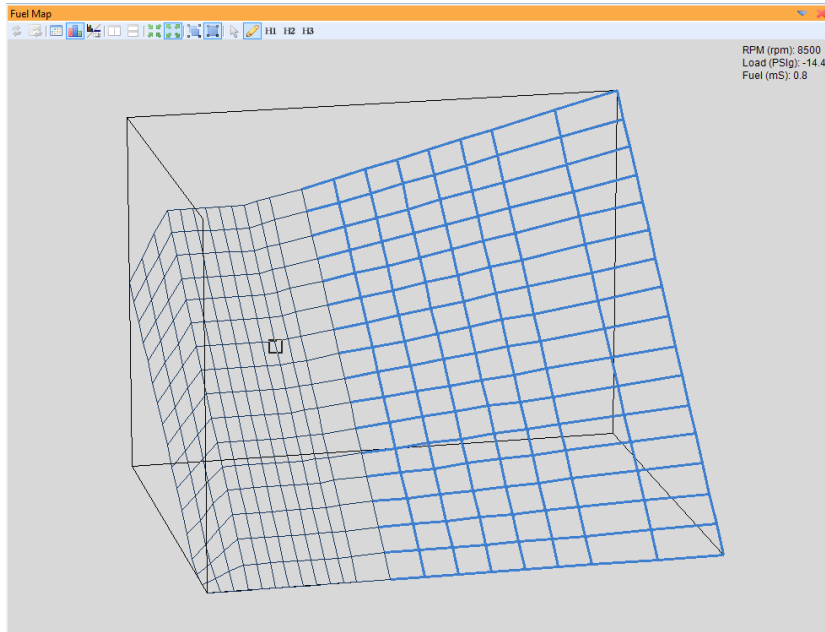

Before **flatten right**. Area of interest highlighted.

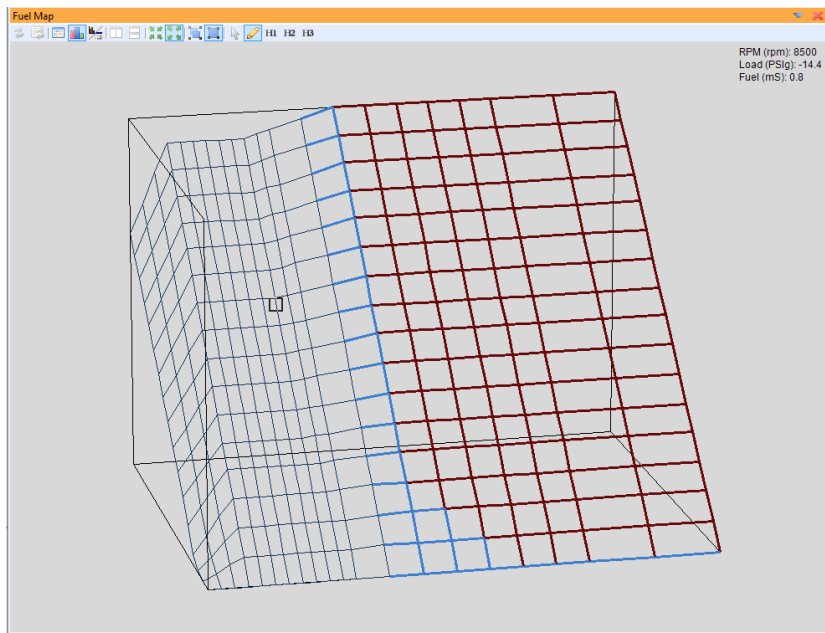

After **flatten right**. Flatten left, up and down results are similar.

Part 3 – Tuning Guide

Background

What is “Tuning”? Tuning can mean anything from adjusting the idle mixture screw on your carburetor to experimenting with custom length headers for your engine to setting up the flow ratio between primary and secondary injectors for your EFI calibration. Tuning covers a wide range of topics and not all are related to fuel injection. For the purpose of this manual, tuning refers to the act of making changes to a calibration file for an AEM engine management system (EMS) to optimize the performance of an engine.

In its most basic form, EFI tuning involves optimizing the fuel flow and spark advance variables to maximize performance and economy.

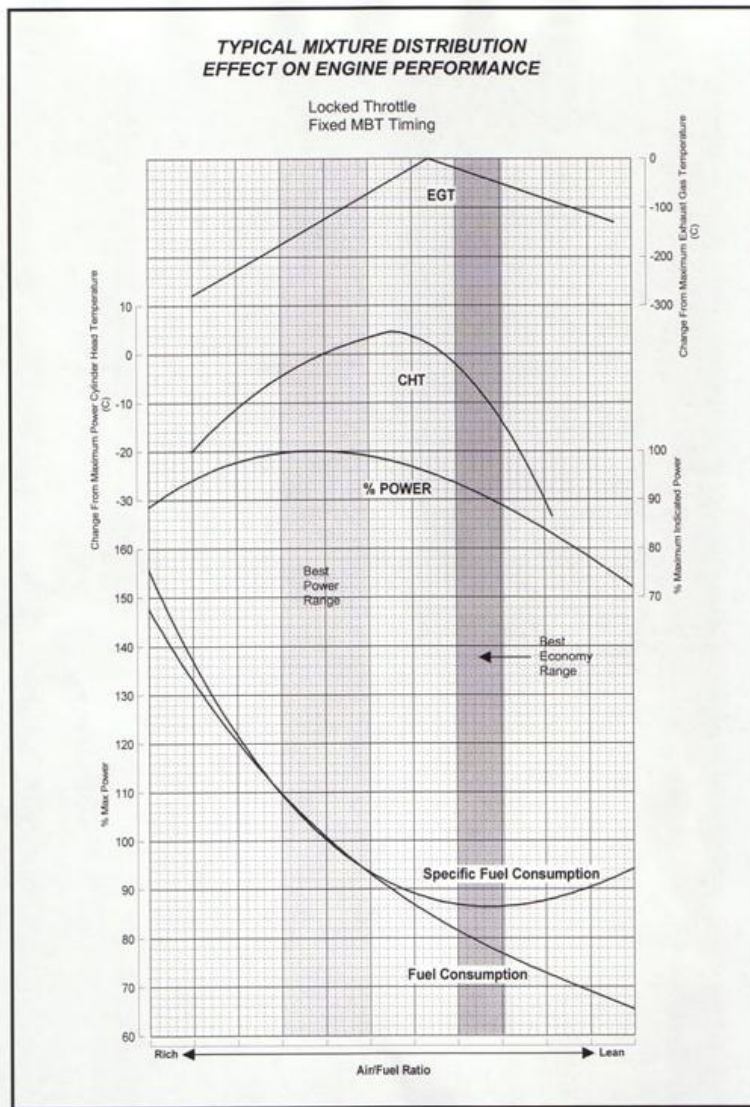

Fuel Tuning General Concepts

The chart at left illustrates the effect of fuel flow on engine performance at a constant operating set point (fixed RPM and throttle position). This kind of data is recorded under laboratory engine testing conditions. The test is started at a very rich air/fuel ratio. The mixture is leaned at a controlled rate and data is recorded along the way. The first transition occurs when horsepower reaches a peak and begins to fall again (best power AFR). The next transition is when cylinder head temperature reaches a peak and begins to fall. The next item of interest is peak exhaust gas temperature (EGT). Shortly afterwards, the specific fuel consumption reaches a minimum and begins to increase (best economy range) indicating the engine is running at a mixture that is so lean, it is becoming difficult to support combustion.

Spark Tuning General Concepts

The ignition timing or spark timing value refers to the distance in crank degrees between the spark plug firing event (initiating combustion) and the uppermost point of the pistons stroke (top center TC, top dead center TDC, etc.)

If the start of the combustion process is progressively advanced before TC, the compression stroke work transfer (which is from the piston to the cylinder gases) increases. If the end of the combustion process is progressively delayed by retarding the spark timing, the peak cylinder pressure occurs later in the expansion stroke and is reduced in magnitude. These changes reduce the expansion stroke work transfer from the cylinder gases to the piston. The optimum timing which gives the maximum brake torque - called maximum brake torque or MBT timing occurs when the magnitudes of these two opposing trends just offset each other. Timing which is advanced or retarded from this optimum gives lower torque. MBT timing defines the optimum point (maximum brake torque) for peak cylinder pressure relative to crank angle.

Certain operating conditions, combustion chamber designs, fuel types, etc. will prohibit an engine from reaching MBT timing before detonation occurs. Detonation, or spark knock is caused by the combustion gases spontaneously combusting at the outer edges of the piston before the normal combustion flame front reaches those areas. This causes pressure spikes that can damage the engine over time.

Every engine will have different spark timing requirements. Unlike fuel tuning where you can take advantage of inexpensive, commonly available wideband oxygen sensor kits, spark tuning requires expensive laboratory equipment for complete optimization. Spark tuning is best accomplished on an engine dyno. If that is not practical, a chassis dyno is the next best thing. Even with the use of a dyno though, spark tuning requires experience to know where to start and what kind of changes to make. Ignition timing values can range from 50+ degrees BTDC to 15+ degrees after top dead center for certain extreme conditions on race vehicles.

Calibration Setup

Base Calibrations

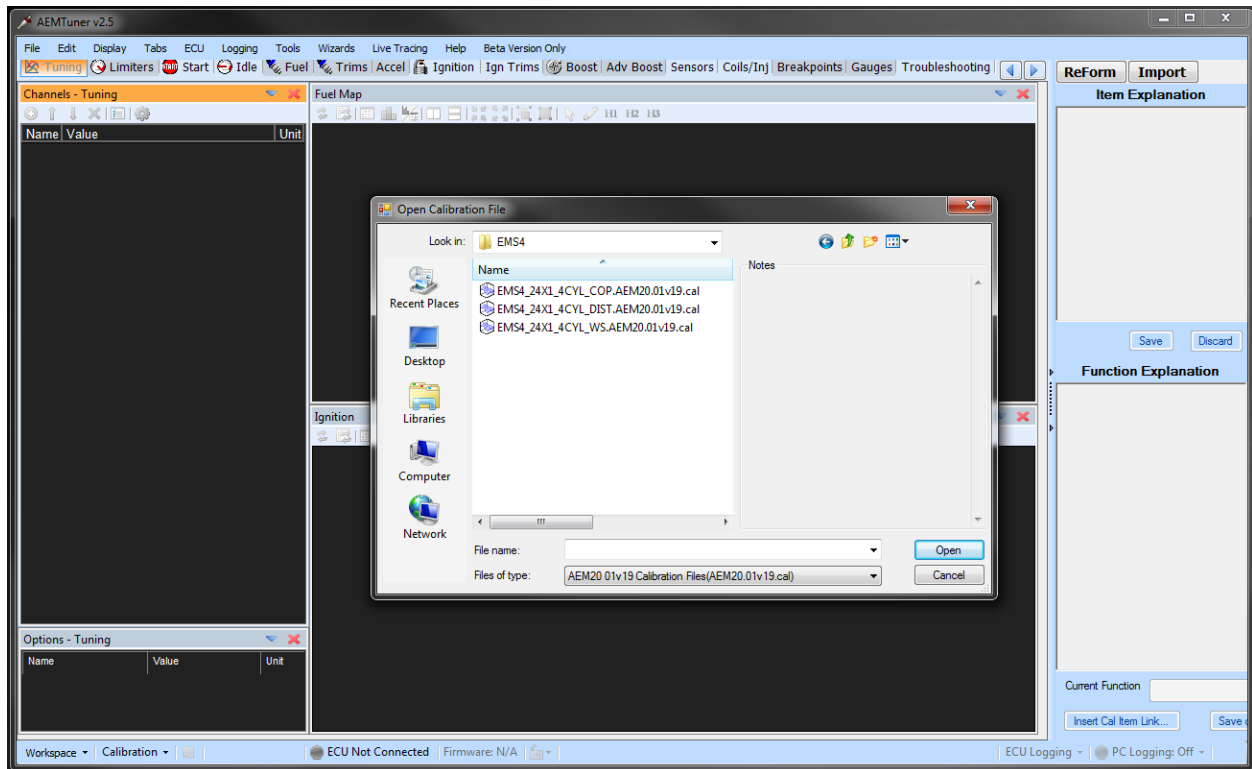

There are several base calibrations that can be used as a starting point. They are installed with the software and located here:

C:\Program Files\AEM\AEMTuner\Calibrations\AEM Updates\EMS4

AEM is constantly adding to, updating and improving the base calibration library. Go to the File menu and select *Calibration Notes...* for information on each file. Example shown below:

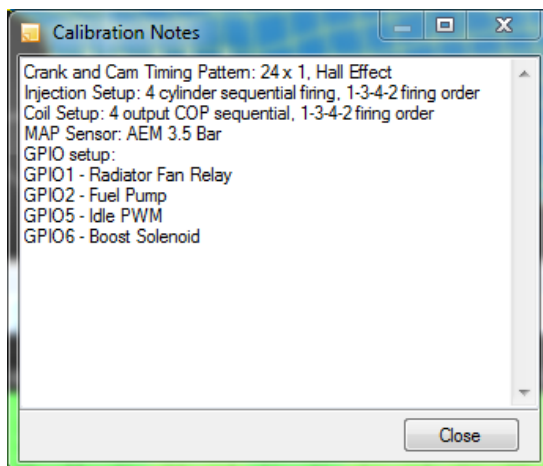

Timing Pattern Basics

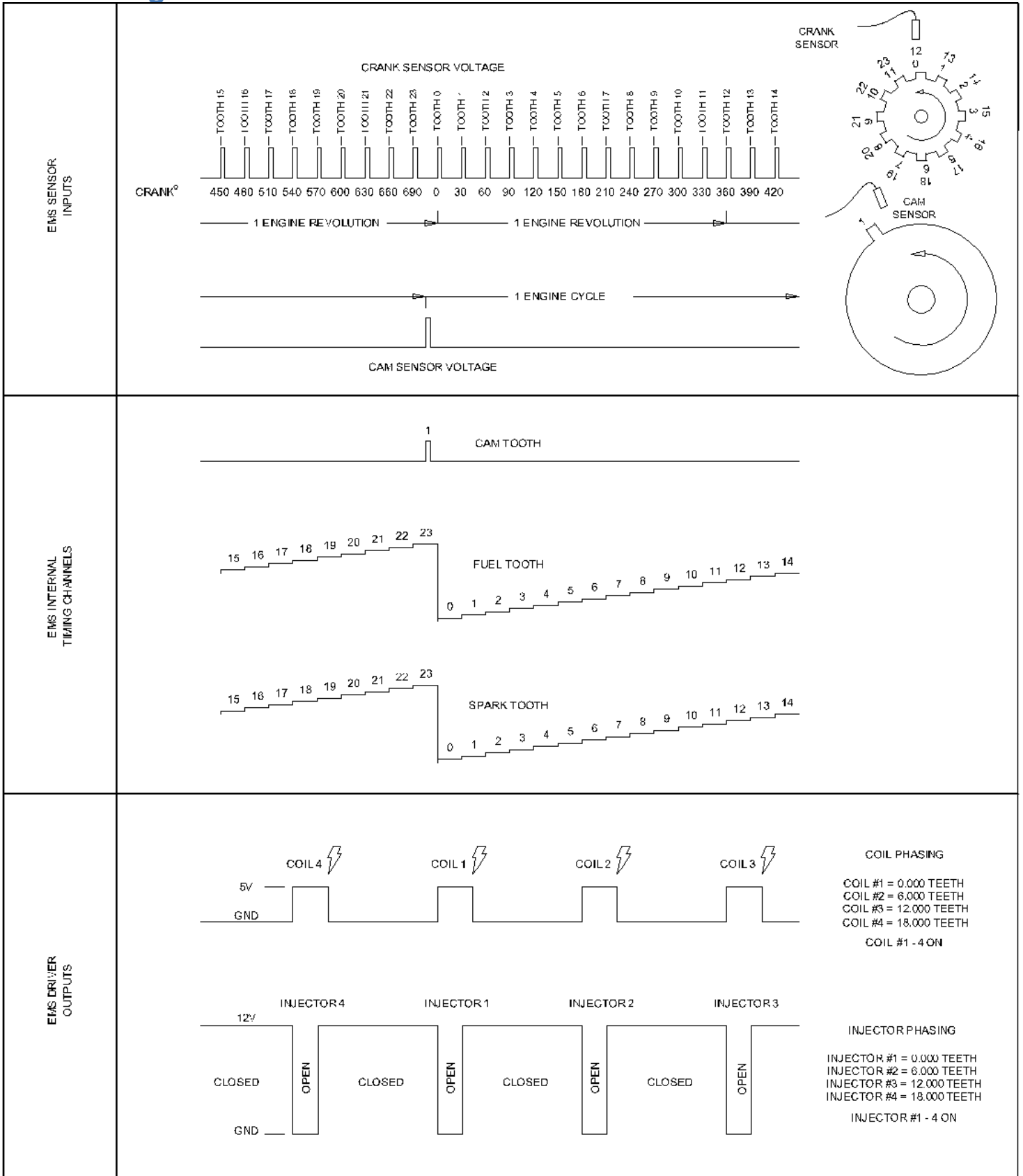

When the “teeth” on a toothed wheel pass by a sensor, the sensor creates a voltage pattern that is used by the ECU for many important calculations. The example above shows two different toothed wheels, one that rotates with the crankshaft. The other rotates with the camshaft (1/2 engine speed). Representative voltage signal patterns for one complete engine cycle (2 revolutions) are also shown. The calibration file must contain the proper settings to define this pattern for the ECU.

In most cases, AEM will provide either a base calibration or a crank and cam sensor wizard that can be used to define these settings. It's important to understand some basic concepts though, especially if there are problems to troubleshoot on universal applications.

WARNING! – Improper use of these settings can lead to engine damage.

Many different crank and cam input configurations are possible with an AEM EMS. The diagram above illustrates a very basic even tooth pattern along with fuel output phasing and spark output phasing setups. The following crank and cam edge selection options are used in this example:

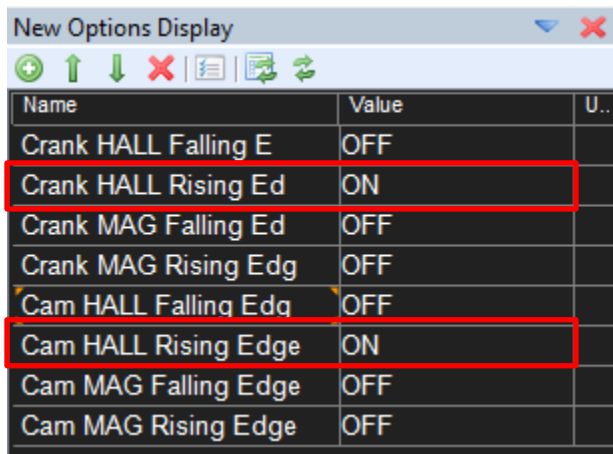

Name	Value	U..
Crank HALL Falling E	OFF	
Crank HALL Rising Ed	ON	
Crank MAG Falling Ed	OFF	
Crank MAG Rising Edg	OFF	
Cam HALL Falling Edg	OFF	
Cam HALL Rising Edge	ON	
Cam MAG Falling Edge	OFF	
Cam MAG Rising Edge	OFF	

Crank Hall Rising Ed(ge) = ON, Define the rising edge of the crank sensor pattern as a significant edge. A significant edge is defined as an edge that increments the fuel and spark tooth counts.

Cam Hall Rising Edge = ON, Define the rising edge of the cam sensor pattern as a significant edge. When this edge is detected, the Cam Tooth channel will increment.

All other edge selections are turned off. *The “MAG” edge settings (EMS-4 applications only) are used for VR or magnetic type sensors. They are completely independent inputs. See pinout sheet or schematic for more information.*

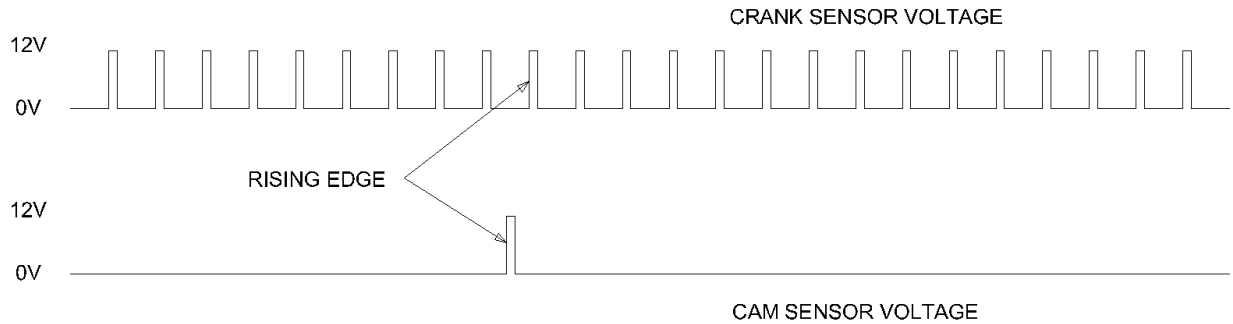

The following Sync Setup options are used in this example:

Name	Value	Unit
Fuel Teeth	24	teeth
Spark Teeth	24	teeth
Wheel Teeth	24	teeth
Sync Teeth	1	teeth
Sync Cam Count	ON	
Sync Error Reset	3	

Fuel Teeth = 24, Defines how many significant crank teeth edges are to be used for fuel injector phasing calculations.

Spark Teeth = 24, Defines how many significant crank teeth edges are to be used for ignition coil output phasing calculations.

Wheel Teeth = 24, Defines how many significant teeth are expected during one engine revolution. Used for engine RPM calculation.

Sync Teeth = 1, How many cam teeth edges the ECU must see during one complete engine cycle. In this simple case, there is only one.

Sync Cam Count = ON, Defines one of several different synchronizations strategies available. This is the most basic where the Cam Tooth channel must equal the value defined for the Sync Teeth option. In this case, it must equal 1.

The Crank Tooth Control Table



The tooth control table has many different functions. The most basic of which is to tell the ECU what to do when it sees a significant edge on the crank sensor input. The values are plotted versus “A Tooth”. The A Tooth count will increment on every edge the pattern. In more complex situations, the table can be used as a translator to convert a complex pattern into a common evenly spaced pattern of 24 fuel teeth per cycle as shown in the examples above.

A value of “5” in the table tells the ECU to process the significant edge. In other words, increment the fuel and spark tooth count by 1. The *Timing Pattern Basics* diagram above shows what the internal fuel and spark tooth counts would look like for one complete engine cycle. These are then used as reference values for fuel and ignition phasing settings.

Fuel Phasing and Injector Setup

The fuel and spark outputs from the EMS can be defined many ways. Our example is a 4 cylinder engine with 4 injector outputs and 4 coil outputs. This is an *even fire* engine meaning that the angle between each cylinder firing event is the same. A 4 cylinder even fire engine will have a firing event every 180 degrees.

$$720 \text{ crank degrees total} / 4 \text{ cylinders} = 180 \text{ degrees per firing event}$$

A timing pattern with 24 “fuel teeth” such as the one in the examples above means there are 30 crank degrees per “tooth” edge. If an injector must fire every 180 degrees, the outputs must be set up to fire every 6 “teeth”.

$$180 \text{ degrees per event} / 30 \text{ degrees per tooth} = 6 \text{ teeth per firing event}$$

Injectors						
Injector Name	Active	Knock Sensor #1	O2 Feedback	EGT Feedback	Injector Type	Injector Phasing
Injector #1	ON <input checked="" type="checkbox"/>	ON <input checked="" type="checkbox"/>	O2 #1 ▾	EGT #1 ▾	Primary ▾	0.000
Injector #2	ON <input checked="" type="checkbox"/>	ON <input checked="" type="checkbox"/>	O2 #1 ▾	EGT #1 ▾	Primary ▾	6.000
Injector #3	ON <input checked="" type="checkbox"/>	ON <input checked="" type="checkbox"/>	O2 #1 ▾	EGT #1 ▾	Primary ▾	12.000
Injector #4	ON <input checked="" type="checkbox"/>	ON <input checked="" type="checkbox"/>	O2 #1 ▾	EGT #1 ▾	Primary ▾	18.000

Injector phasing is defined in the window above.

Injector Name – The injector output. See application pinout sheet or schematic for more information.

Active – Enables or disables an injector output. *Note that a power cycle is necessary after making changes to these settings.*

Knock Sensor #1 – Assigns an injector to a knock sensor input. Fuel changes defined in the knock control function will be applied according to these settings. The number of knock sensor inputs varies by application. See pinout sheet or schematic for more information.

O2 Feedback – Assigns an injector to an O2 sensor input. Fuel changes defined in the O2 feedback control function will be applied according to these settings.

EGT Feedback – Assigns an injector to an EGT sensor. EGT fuel trims will be applied according to these settings. The number of EGT sensor inputs varies by application. See pinout sheet or schematic for more information. *Note that the EMS-4 systems do not have EGT sensor input circuits.*

Injector Type – Defines an injector as “Base” if staged injection is not being used, “Primary” if used as a primary injection in a staged setup or “Secondary” if used as a secondary injector in a staged setup.

Injector Phasing – Defines the injector phasing. In the example above, the injector outputs will fire in order 1 – 2 – 3 – 4 every 6 teeth.

Alternative setup – Injectors outputs fire in “Cylinder Firing Order”

Injectors						
Injector Name	Active	Knock Sensor #1	O2 Feedback	EGT Feedback	Injector Type	Injector Phasing
Injector #1	ON <input checked="" type="checkbox"/>	ON <input checked="" type="checkbox"/>	O2 #1 ▾	EGT #1 ▾	Base ▾	0.000
Injector #2	ON <input checked="" type="checkbox"/>	ON <input checked="" type="checkbox"/>	O2 #1 ▾	EGT #1 ▾	Base ▾	18.000
Injector #3	ON <input checked="" type="checkbox"/>	ON <input checked="" type="checkbox"/>	O2 #1 ▾	EGT #1 ▾	Base ▾	6.000
Injector #4	ON <input checked="" type="checkbox"/>	ON <input checked="" type="checkbox"/>	O2 #1 ▾	EGT #1 ▾	Base ▾	12.000

Some tuners may want to connect injector output #1 to cylinder #1, injector output #2 to cylinder 2, etc. The example above shows how this configuration would be defined assuming the engine firing order is 1 – 3 – 4 – 2.

Injector Advance Table

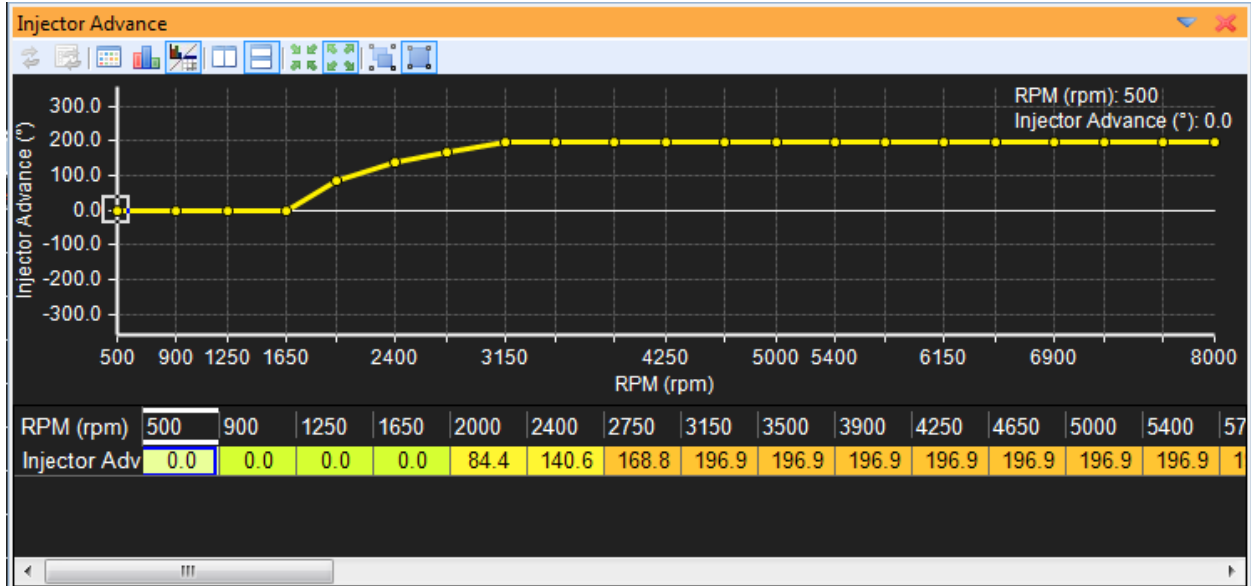

The **Injector Advance** table controls the timing of the injection events. The units are in crank degrees and are vs RPM breakpoints. Range is -360 to +360 degrees from the first crank tooth after synchronization.

A more complex example

For a more complex example of the tooth control table function, please refer to the *60-2 Crank with Single Cam Sync* diagram. This is a window into the inner workings of the EMS and explains how the tooth control table can be used to convert a 60-2 crank trigger wheel (sometimes also referred to as a 58X pattern) into a “24 fuel teeth” configuration similar to the one in the basic example above. This pattern requires the missing tooth or MX sync strategy. Here the tooth control table is used as a “divide by 5” function to count every 5th crank tooth edge as a fuel tooth. This effectively converts the fuel tooth count from 6 crank degrees per tooth to a more standard 30 degrees per tooth. Once this is done, all other settings are the same as above.

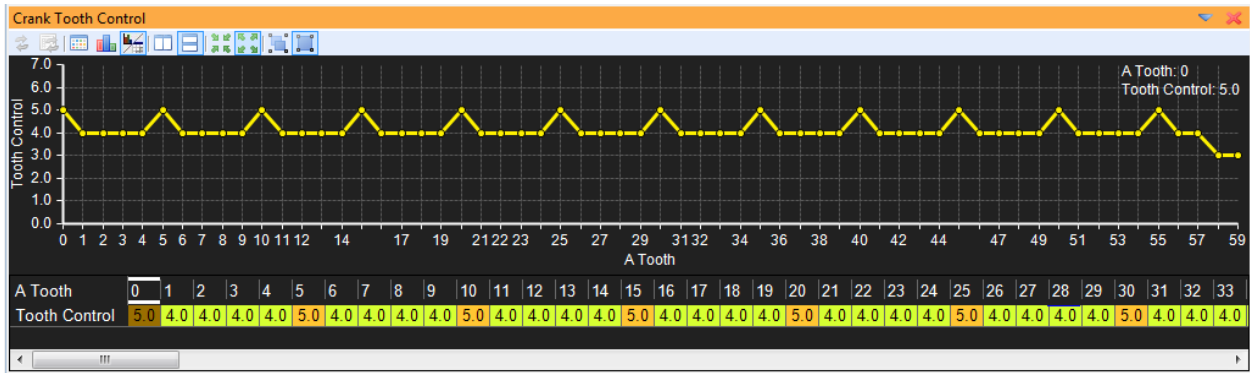

The sync strategy takes advantage of the missing tooth sections of the trigger wheel.

Options - Sync Setup		
Name	Value	Unit
Missing	2	teeth
MX Sync Test	57	tooth
MX Time	25.0	%
Sync Teeth	1	teeth
Sync Error Reset	3	

Missing – Tells the EMS to look for 2 missing crank tooth edges.

MX Sync Test – Must be set to the number of normal crank tooth edges between missing edges. In this case there are 57 (really 58 but the first edge is counted as a zero)

MX Time – Multiplier used internally by the EMS to define the “missing tooth window”

Sync Teeth – Defines the number of cam sync edges between missing crank edges. Note that on a 60-2 crank trigger wheel (or any missing tooth trigger wheel for that matter that is mounted on the crankshaft), the pattern occurs twice per engine cycle (2 revs = 1 cycle) so the EMS will count 1 sync error on the second revolution. This is normal in this case.

Sync Error Reset – Must be set just higher than the number of expected sync errors within one engine cycle. When this value is exceeded, the EMS will consider the system in fault and disable fuel and spark outputs until sync can be re-established.

Ignition Phasing and Coil Dwell Discussion

Basic ignition phasing settings are similar to those for the fuel injectors. Referring again back to our example above, there are 4 ignition outputs that fire sequentially spaced 180 crank degrees or 6 teeth apart.

Coils				
Coil Name	Active	Knock Sensor #1	Coil Position	Coil Phasing
Coil #1	ON <input checked="" type="checkbox"/>	ON <input checked="" type="checkbox"/>	Leading ▾	0.000
Coil #1B	OFF <input type="checkbox"/>	ON <input checked="" type="checkbox"/>	Leading ▾	0.000
Coil #2	ON <input checked="" type="checkbox"/>	ON <input checked="" type="checkbox"/>	Leading ▾	6.000
Coil #2B	OFF <input type="checkbox"/>	ON <input checked="" type="checkbox"/>	Leading ▾	0.000
Coil #3	ON <input checked="" type="checkbox"/>	ON <input checked="" type="checkbox"/>	Leading ▾	12.000
Coil #3B	OFF <input type="checkbox"/>	OFF <input type="checkbox"/>	Leading ▾	0.000
Coil #4	ON <input checked="" type="checkbox"/>	ON <input checked="" type="checkbox"/>	Leading ▾	18.000
Coil #4B	OFF <input type="checkbox"/>	OFF <input type="checkbox"/>	Leading ▾	0.000

Coil Name – The coil output. See application pinout sheet or schematic for more information. Coils #1B – #4B are paired outputs for Coils #1 - #4. In other words, they are the same output but each firing event can be phased and trimmed independently of the other.

Active – Enables or disables the coil output. *Note that a power cycle is necessary after making changes to these settings.*

Knock Sensor #1 – Assigns an coil output to a knock sensor input. Ignition timing changes defined in the knock control function will be applied according to these settings. The number of knock sensor inputs varies by application. See pinout sheet or schematic for more information.

Coil Position – Options are leading or trailing. Leading is the default. Trailing ignition outputs are used on rotary engine applications.

Coil Phasing – Defines the coil output phasing. In the example above, the coil outputs will fire in order 1 – 2 – 3 – 4 every 6 teeth.

Alternative setup – Coil outputs fire in “Cylinder Firing Order”

Coil Name	Active	Knock Sensor #1	Coil Position	Coil Phasing
Coil #1	ON <input checked="" type="checkbox"/>	ON <input checked="" type="checkbox"/>	Leading	0.000
Coil #1B	OFF <input type="checkbox"/>	ON <input checked="" type="checkbox"/>	Leading	0.000
Coil #2	ON <input checked="" type="checkbox"/>	ON <input checked="" type="checkbox"/>	Leading	18.000
Coil #2B	OFF <input type="checkbox"/>	ON <input checked="" type="checkbox"/>	Leading	0.000
Coil #3	ON <input checked="" type="checkbox"/>	ON <input checked="" type="checkbox"/>	Leading	6.000
Coil #3B	OFF <input type="checkbox"/>	OFF <input type="checkbox"/>	Leading	0.000
Coil #4	ON <input checked="" type="checkbox"/>	ON <input checked="" type="checkbox"/>	Leading	12.000
Coil #4B	OFF <input type="checkbox"/>	OFF <input type="checkbox"/>	Leading	0.000

Like the injector phasing example above, some may want to connect coil output #1 to cylinder #1, coil output #2 to cylinder 2, etc. The example above shows how this configuration would be defined assuming the engine firing order is 1 – 3 – 4 – 2.

Dwell Discussion

The diagram below illustrates a basic inductive ignition system setup with four independent ignition outputs (Coils 1 – 4).

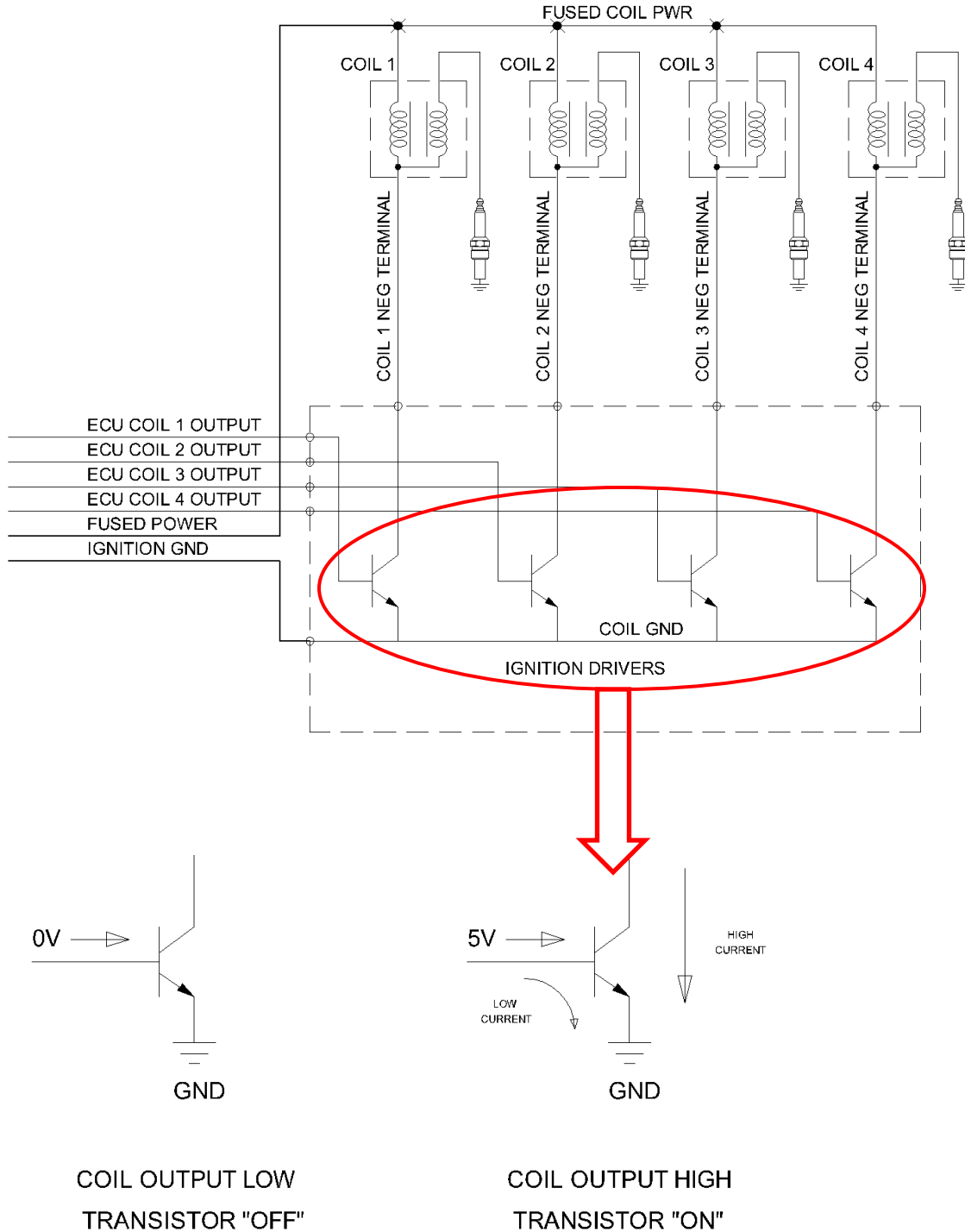

Transistors serve many functions but in this case they are applied as *Power Drivers*. The input circuit to the transistor from the ECU requires very little current flow to turn the transistor ON. When the transistor is ON, a high current capacity path is created between the coil negative terminal and ground. High current means more temperature to dissipate. A stand-alone ignition driver module or a driver module built into a coil assembly is designed to efficiently dissipate this heat. The more current flow, the more heat must be dissipated. The amount of current the drivers must sink to ground during each charge and fire event is determined by the *dwell time settings*. What is Dwell Time? The diagram below describes dwell time.

The process begins when the ECU sends a signal to the transistors turning on the current to the ignition coils primary winding. This 'charging' stores energy in the coils magnetic circuit. The current is then switched off. As the magnetic field begins to collapse the coil tries to resist the drop in current causing the voltage in the secondary winding to rise rapidly, this high voltage breaks down the air/fuel mixture in the spark gap allowing a spark to pass, causing ignition of the air/fuel mixture.

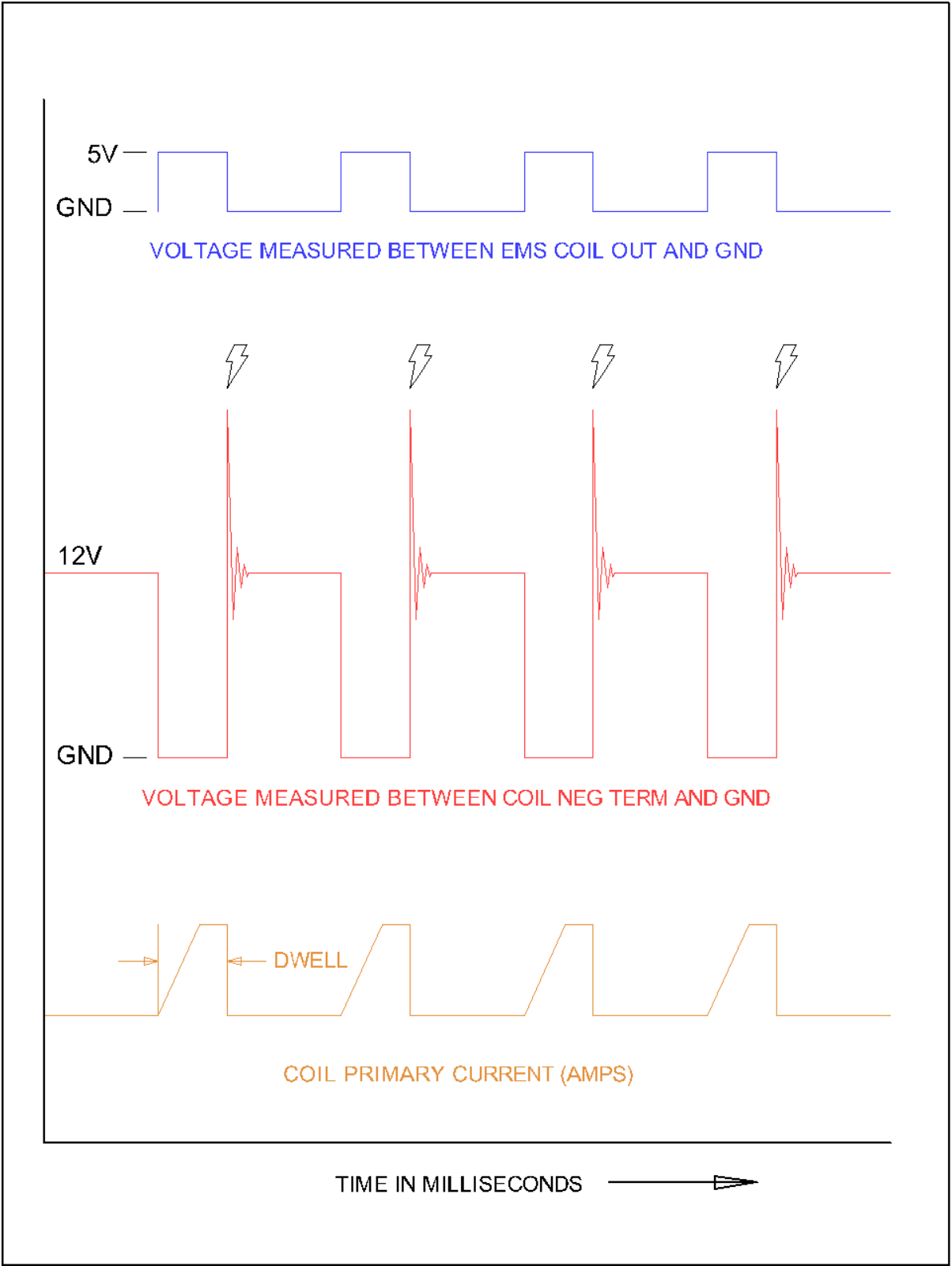

Coil dwell is configured in the EMS calibration using the following options and tables:

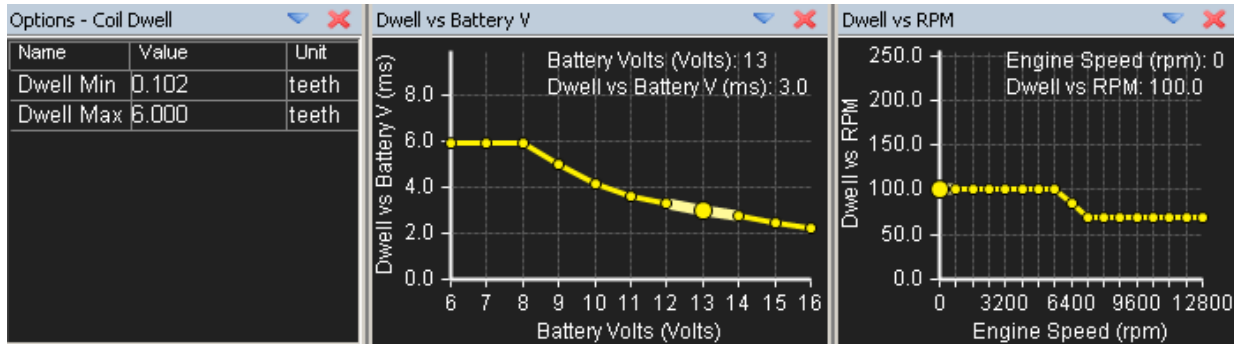

$$\text{Ignition Charge Time (ms)} = (\text{Dwell vs Battery V value}) * (\text{Dwell vs RPM value})$$

Example: Calibration contains the following values:

Dwell vs Battery V = 3.0 ms (at 13V)
 Dwell vs RPM = 100% (most RPM)

$$\text{Charge Time} = 3.0 * 100\% = 3.0 \text{ ms}$$

The **Dwell Min** and **Dwell Max** options are used to define the minimum and maximum allowed dwell time in units of teeth. The actual time in milliseconds that these values represent will depend on the timing pattern configuration and the engine RPM.

WARNING! INCORRECT IGNITION DWELL SETTINGS CAN LEAD TO COIL OVERHEATING AND A POTENTIAL FIRE HAZARD. CONTACT YOUR IGNITION COIL MANUFACTURER FOR RECOMMENDED DWELL SETTINGS.

Set up RPM and Load axes

The RPM (X) and Load (Y) axes of the 3D maps must be set up before any calibration work is to be done. The matrix for all 3D maps except the idle fuel and idle ignition maps is 23 (X) by 17 (Y). The set points may be linear or non linear. Most road cars with relatively mild tuning characteristics use linear X & Y axes. On engines that are modified with narrow power bands the non-linear set up is often used. The reason a non-linear set up is good for highly tuned engines is because the airflow through them is very non linear. The set up of the X & Y axes allows the tuner to accommodate the non-linear characteristics of the engine by placing the set points for RPM and Load closer together in the region where drivability is critical.

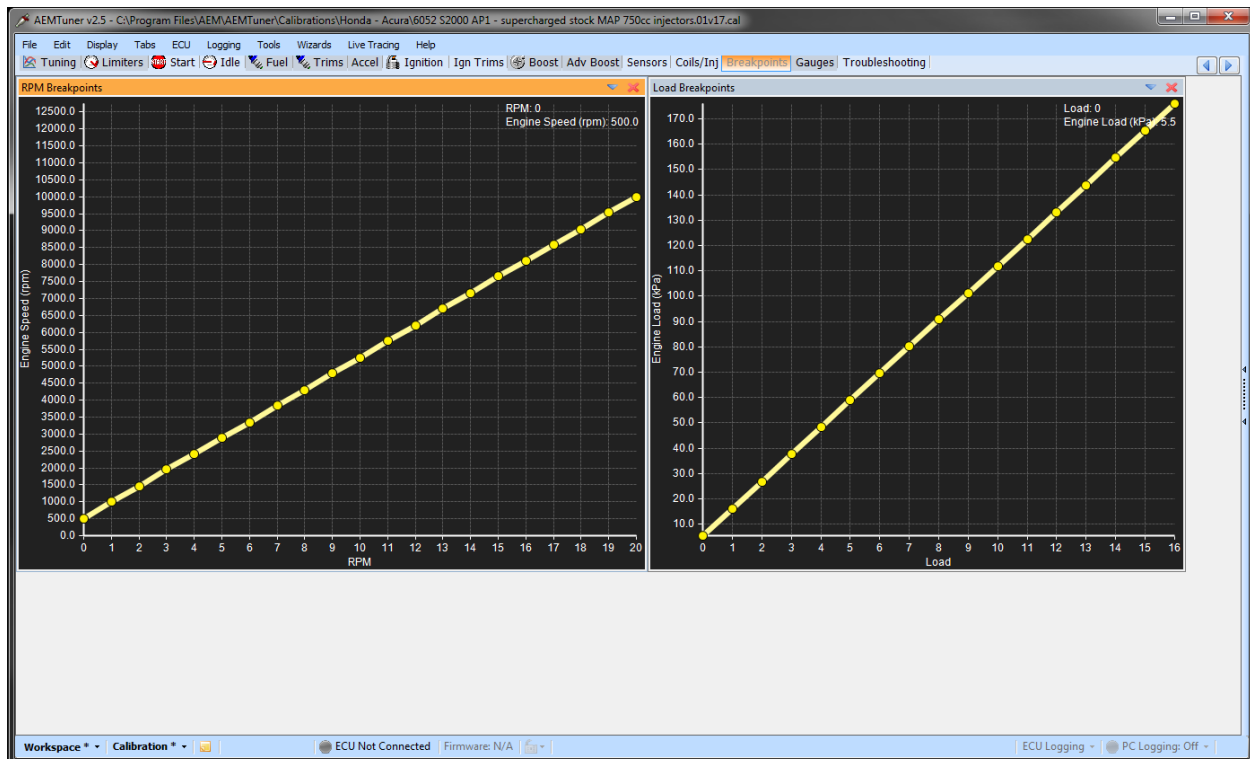

Linear Load and RPM Setup

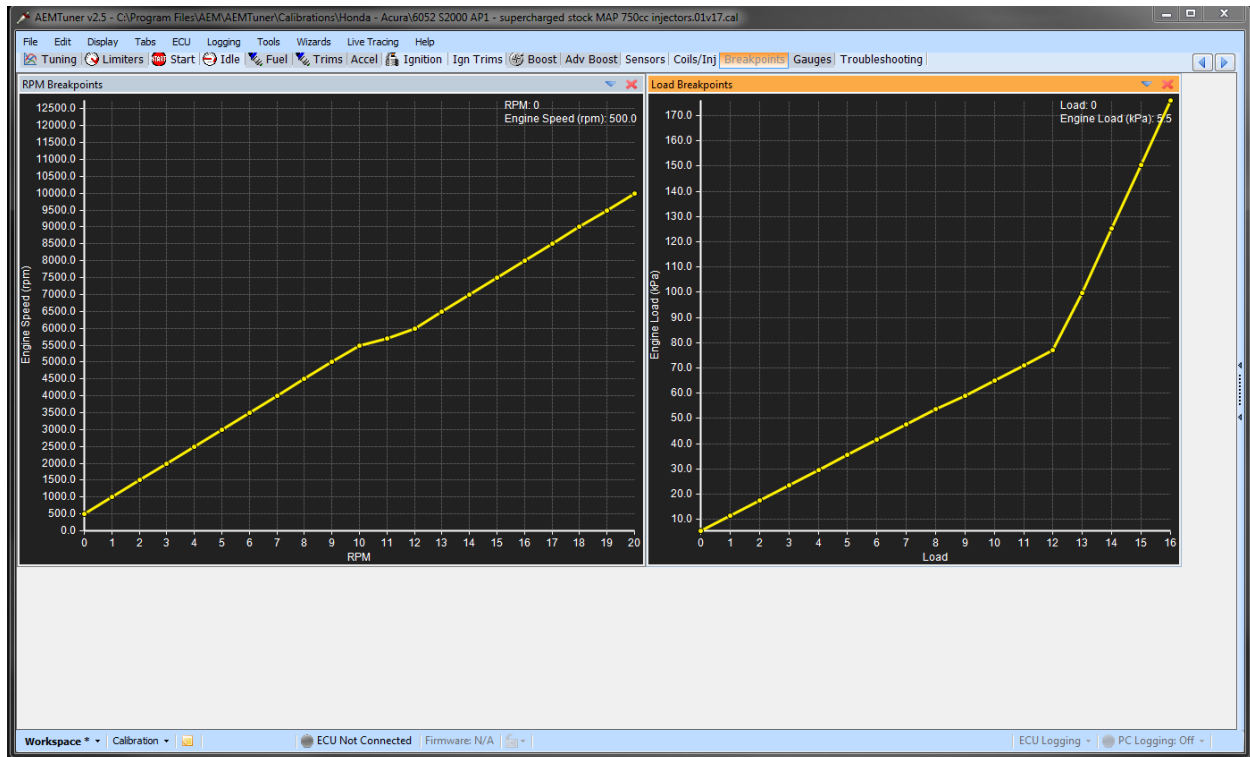

Non-Linear Load and RPM Setup

EFI Sensors

TPS (Throttle Position Sensor)

The TPS determines the position of the throttle blade in the throttle body. This input is used to determine rate of throttle angle change (both positive and negative), idle position, and discrete throttle opening for TPS-based calibrations. The TPS typically is a potentiometer bolted to the end of the throttle shaft. Rotating the throttle varies the resistance, and consequently, the voltage returned to the ECU is a function of that resistance. The rate of change is measured to determine whether a vehicle is accelerating or decelerating. Based on this rate of change, the proper amount of fuel is either added or subtracted from the base calibration to achieve the proper amount of fuel for the operating condition.

The TPS is also used to determine if the vehicle is idling. When the throttle is at rest, the vehicle is considered to be either idling or under heavy deceleration, and the fuel and ignition calibrations are adjusted for optimum idle characteristics. The TPS can be used as a calibration input if the AEM EMS is set up to be a throttle position vs. RPM based mapping scheme. This type of mapping allows the tuner to set up the fuel map based on the throttle angle from 0 to 100% on the Y-axis of the map, with the X-axis being RPMs. This type of mapping is usually best for naturally aspirated racing engines with individual runner inlet manifolds and no plenum chamber or very aggressive cams.

While on the subject of throttle opening we must caution you to make sure that full throttle is achieved by having someone verify that the throttle blade is opening fully and up against the stop on the throttle body while you depress the throttle. Also, make sure that nothing interferes with the full range of the throttle opening, such as a floor mat.

MAP (Manifold Pressure Sensor)

Before any discussion is held of what a MAP sensor is, it is necessary to understand what manifold pressure is. The definition of pressure is the force per unit area, thus it is an intensive quantity formed as a ratio force and area. So if a 100-pound force is exerted on a piston that has a total area of 100 in² the pressure acting on each square inch is 100lb/100 in² or 1 PSI. If the same force were to be applied to a piston with an area of only 1 in² the pressure exerted on the piston would be 100 lb/ 1 in² or 100 PSI. Now consider if a 100-pound person stepped on a nail that has a tip that is only .010" diameter. This would yield a pressure of 10,000 pounds. (100 lb / .010 in² = 10,000 pressure)

Realistically, there is no such thing as "manifold vacuum," just low manifold pressure. The average air pressure exerted on Earth under standard conditions is 14.7 psi or 101.325 kilopascals (kpa). An engine ingests air by creating a differential of pressure across the engine via the movement of the pistons in their bores. When a piston moves down the bore, pressure in the bore is reduced. When the inlet valve opens, the awaiting relative higher-pressure air above the inlet valve enters the chamber and fills the void caused by the motion of the piston in the bore. On an engine without a means of forcing air into the engine, the most this pressure can be is whatever the atmospheric pressure of the day is. At sea level the average pressure is 14.7 psi.

It is common to refer to low manifold pressure as vacuum, which is how we will refer to low pressure for the purposes of this discussion. Pressure is measured in two ways: one is absolute pressure, and the other is gauge pressure. The difference between these is where the zero point of each scale starts. With absolute pressure, zero is a complete void of all pressure. With the more common gauge pressure, zero is at standard atmospheric pressure (14.7 psi). Anything below 14.7 psi is referred to as vacuum and anything above that is referred to as boost or positive pressure.

Closed or very small throttle angles are associated with low manifold pressure (a vacuum on the gauge measuring style), and large throttle angles or full throttle is considered high manifold pressure (0 on the gauge measuring style).

Typical boost or vacuum gauges used in automotive applications use the gauge type of readout. In automotive engineering, the absolute method of measuring pressure is used. To illustrate the different ways to read manifold pressure refer to the accompanying chart.

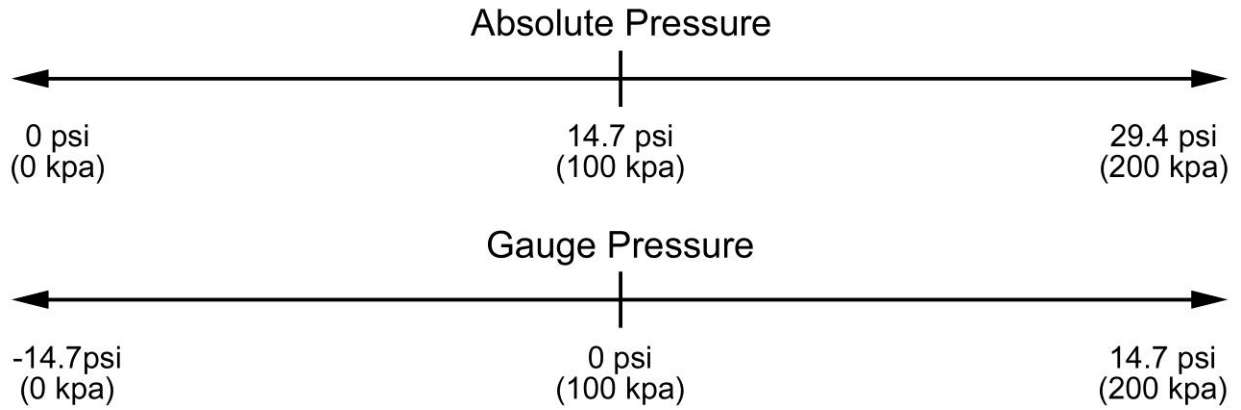

We find it easiest to work with the accepted standard of kilopascals (kpa) of absolute pressure. It is important to know the relationships of the various nomenclatures of pressure. The units of pressure in use today are;

$$1 \text{ bar (b)} = 100 \text{ kilopascals (kpa)} = 14.5 \text{ psi} = 29.529'' \text{ Hg.}$$

$$1 \text{ atm.} = 101.325 \text{ kpa} = 14.7 \text{ psi} = 29.92'' \text{ Hg} = 1.01325 \text{ b}$$

PSI Absolute	Kpa	Inches Hg	Bar	Pressure Gauge
1.00	6.89	2.04	0.07	-27.89 in Hg ↓
2.00	13.79	4.07	0.14	-25.86
3.00	20.68	6.11	0.21	-23.82
4.00	27.58	8.14	0.28	-21.79
5.00	34.47	10.18	0.34	-19.75
6.00	41.37	12.22	0.41	-17.71
7.00	48.26	14.25	0.48	-15.68
8.00	55.16	16.29	0.55	-13.64
9.00	62.05	18.32	0.62	-11.61
10.00	68.95	20.36	0.69	-9.57
11.00	75.84	22.40	0.76	-7.53
12.00	82.74	24.43	0.83	-5.50
13.00	89.63	26.47	0.90	-3.46
14.00	96.53	28.50	0.97	-1.43
14.70	101.35	29.93	1.01	0
15.00	103.42	30.54	1.03	0.3 psi ↓
16.00	110.32	32.58	1.10	1
17.00	117.21	34.61	1.17	2
18.00	124.11	36.65	1.24	3
19.00	131.00	38.68	1.31	4
20.00	137.90	40.72	1.38	5
21.00	144.79	42.76	1.45	6
22.00	151.68	44.79	1.52	7
23.00	158.58	46.83	1.59	8
24.00	165.47	48.86	1.65	9
25.00	172.37	50.90	1.72	10
26.00	179.26	52.94	1.79	11
27.00	186.16	54.97	1.86	12
28.00	193.05	57.01	1.93	13
29.00	199.95	59.04	2.00	14
30.00	206.84	61.08	2.07	15
31.00	213.74	63.12	2.14	16
32.00	220.63	65.15	2.21	17
33.00	227.53	67.19	2.28	18
34.00	234.42	69.22	2.34	19
35.00	241.32	71.26	2.41	20
36.00	248.21	73.30	2.48	21

Bold type is standard atmosphere

Vacuum in Hg"

Standard ATM

Pressure in PSI

The MAP sensor provides manifold pressure information to the ECU for calibration based on MAP vs. RPM. The MAP information is used in both the fuel and ignition Y-axis of their respective maps. On racing engines that use individual runner manifolds, a TPS based fuel map can be used while the ignition can be MAP based. This is desirable because the ignition should always be load based to provide knock free operation.

A MAP sensor reads in absolute pressure, just like the name implies. The amount of pressure indicated by the sensor depends on the amount of voltage feedback delivered to the ECU. As the throttle is opened and closed, or boost is built up in the manifold, the sensor reacts to the changing pressure and outputs a voltage signal to the ECU based on the given pressure.

The MAP sensor has three leads: 5V+ into the MAP sensor, a return to the ECU based upon the resistance of the MAP sensor, and a ground. A MAP sensor **MUST** have a hose routed to it from the inlet manifold in order to read manifold pressure and it **MUST** receive a constant pressure signal to it at all times. If the pressure signal fluctuates, the calibration will be adversely affected because the fuel and ignition values will cycle with the MAP signal.

To avoid varying MAP signals, the pressure line must be connected to the intake plenum. In the case of individual runner manifolds, TPS-based mapping is best.

If a MAP sensor is used for boost compensation or load sensitive ignition timing, an accumulator must be used. An accumulator is a common closed container that has a hose from each runner routed to it. An accumulator dampens the pulsing commonly found in this type of manifold set up, which will aid in the delivery of a steady MAP signal (A fuel pressure regulator can have its pressure source routed to an accumulator for the same reasons).

The AEM PEMS has a variety of MAP sensor ranges to suit everything from naturally aspirated engines, to forced induction engines up to whatever boost can be generated by the turbo or supercharger(s).

Air Temperature Sensor

Manifold Air Temp Sensors (MAT) and Inlet Air Temp Sensors (IAT) are variable resistance thermistors that send a return voltage signal back to the ECU based on the inlet air temp either in the inlet manifold or in the inlet duct to the throttle body (The ECU outputs a +5V power to the sensor and the return voltage is based on the resistance of the sensor). These sensors can also be used as auxiliary temp sensors for any air temp measurement, such as intercooler inlet and outlet temps.

The AEM EMS is compatible with virtually all MAT & IAT sensors. Based on the inlet air temp readings provided by an MAT or IAT, an ECU can add or subtract fuel or ignition timing depending on the given conditions. For example, a typical use for an MAT sensor is to change the ignition timing and fueling of an engine based on inlet air temp. This is particularly useful on forced induction engines where inlet air temps can increase dramatically.

Water Temp Sensor

The coolant temperature sensor (CLT) is a variable resistance thermistor (thermal resistor) that sends a return voltage back to the ECU based on the temperature of the engine coolant. This sensor can also be used for virtually any other type of automotive fluid if it is located in that liquid's respective reservoir. Unlike other types of sensors that emit voltage signals to the ECU, with CLTs the ECU outputs a +5V signal to the CLT and the sensor's resistance determines the return voltage. The AEM EMS is compatible with virtually all CLT sensors.

The CLT provides the ECU with engine temp information. The AEM EMS modifies the base fuel calibration during start and warm up based on the CLT input. In addition to adding fuel, a CLT can signal to the ECU to modify ignition timing at varying engine temps for optimum performance. On racecars, ignition timing is typically advanced during warm up to heat the engine faster. Racecars use an ignition based warm up because usually idle speed motors are not used. On streetcars, where clean emissions are important, we reduce timing based on CLT input to light the catalytic converter(s) off sooner.

O₂ (Oxygen) Sensors

There are many types of O₂ sensors that are employed by vehicle manufacturers, and it is well beyond the scope of this manual to describe all of them. An O₂ sensor provides a reading of the air/fuel ratio (AFR) to the ECU so that it can make the necessary fuel calibration corrections to achieve a desired Air Fuel Ratio (AFR).

An O₂ sensor works by sensing whether there is an abundance or lack of oxygen in the exhaust gases, depending on whether the gas mixture is too rich or too lean. If there is excess oxygen and the mixture is too lean, output voltage from the O₂ sensor to the ECU will be high. The ECU may then compensate by adding fuel. The converse is true of rich mixtures.

Common O₂ sensors include 3-, 4-, and 5-wire heated or wide-band sensors. Three- and 4-wire sensors are ideal for determining whether a vehicle's AFR is at the optimum stoichiometric ratio. Stoichiometric ratio refers to the ideal mixture of fuel and air by mass to completely consume both reactants (gas and air) with nothing left over. Based on the properties of most pump gasoline used today this ratio is typically a 14.64:1 air/fuel ratio. Although this ratio provides the best combustion characteristics with the least emissions output and optimum catalytic converter performance, it is NOT the best AFR for maximum power at full throttle or under boost. This mixture is too lean and may cause engine damage.

AEM currently offers a line of high quality, inexpensive UEGO gauge controllers. Because the AEM gauge utilizes the internal AEM UEGO controller and Bosch UEGO Sensor, it is accurate and repeatable to 0.1 of an air/fuel ratio point! With this, there is no abrupt oscillation as found in many competitor gauges, which utilize a narrow band oxygen sensor detecting only stoichiometry.

Typical production vehicle oxygen sensors rely on “Nernst Cell” technology, commonly called “Narrow Band” and sometimes erroneously described as “Wide Band”. This is a very cost effective method that outputs a voltage based on the oxygen content of the gas being sampled. It is accurate in the region surrounding stoichiometric operation and leaner. Unfortunately, in the rich region where high performance engines usually operate, their accuracy and repeatability is virtually non-existent.

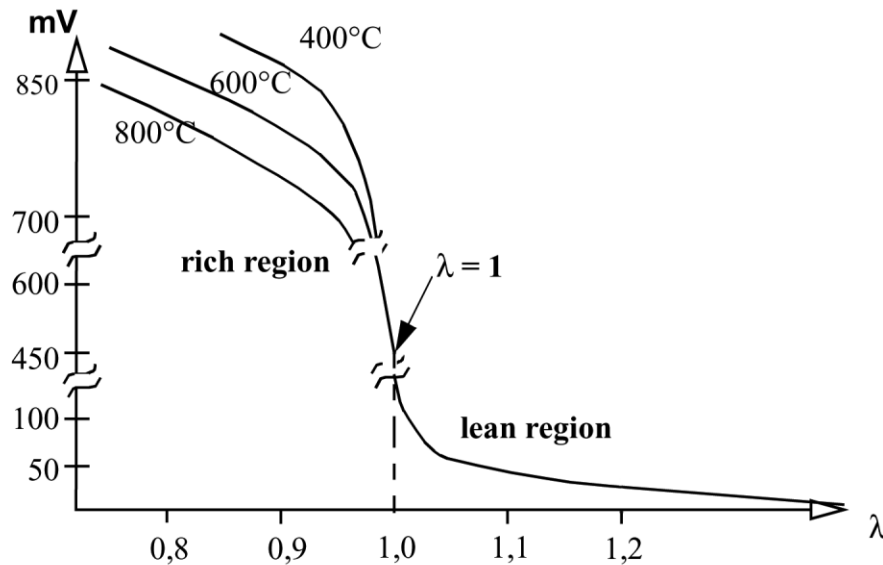

Characteristic curve of a Nernst Cell O2 Sensor

The rich region output of narrow band O2 sensors is temperature dependent, which renders it useless if an accuracy better than 1.5:1 AFR is desired. This is immediately obvious given the fact that a single output voltage actually represents wildly different air fuel ratios depending on the unregulated and unmeasured sensor temperature. These sensors were designed for operating closed loop around stoichiometry (14.64:1 for gasoline), and for performance tuning they are useless.

The heart of the AEM gauge is the Bosch LSU4.2 Universal Exhaust Gas Oxygen (UEGO) sensor. This type of sensor is commonly referred to as “laboratory grade” and works on a different principle than the narrow band oxygen sensor found in most vehicles. Its unique design makes precision AFR measurements possible over the entire operating range.

UEGO sensors use a “current pump” to determine the actual oxygen concentration within the sensing element or. The output is in the form of a very small current, which varies depending on the air-fuel ratio. This is completely different from a narrow band oxygen sensor, which directly outputs a voltage. The UEGO sensor design allows measurement of the exact air fuel ratio over the entire operating range.

The following diagram illustrates the simple installation of an AEM UEGO gauge controller kit.

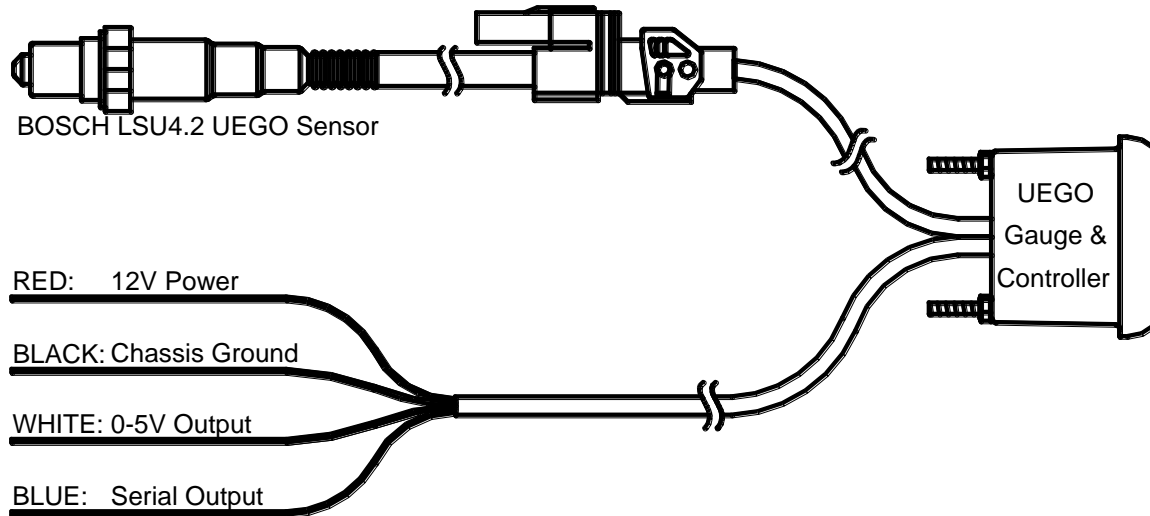

The following is a chart of typical AFRs. **Note that every engine is different and this may not be the optimum set up for your particular vehicle.** The AFRs on this chart are very conservative to minimize the potential for engine damage. These AFRs depend on the condition that ignition timing and fuel octane are adequate enough to prevent knocking. The very low loads found in the lower right corner occur during deceleration, and because there is no “work” being done by the engine, AFRs during deceleration can be very lean. We have seen AFRs of 20.0:1 during deceleration runs.

Naturally Aspirated Piston Engines W/ Pent roof Combustion Chamber

Air/Fuel Ratio

L	100	13.0:1	13.0:1	13.0:1	13.0:1	13.0:1	13.0:1	12.8:1	12.8:1
O	90	13.5:1	13.5:1	13.5:1	13.5:1	13.5:1	13.5:1	13.5:1	13.5:1
A	80	14.0:1	14.0:1	14.0:1	14.0:1	14.0:1	14.0:1	14.0:1	14.0:1
D	70	14.0:1	14.2:1	14.2:1	14.2:1	14.2:1	14.2:1	14.2:1	14.2:1
	60	14.0:1	14.7:1	14.7:1	14.7:1	14.7:1	14.7:1	14.7:1	14.7:1
I	50	14.0:1	14.7:1	14.7:1	14.7:1	14.7:1	14.7:1	14.7:1	14.7:1
N	40	14.0:1	14.7:1	14.7:1	14.7:1	14.7:1	14.7:1	14.7:1	14.7:1
	30	14.0:1	14.7:1	14.7:1	14.7:1	14.7:1	14.7:1	14.7:1	14.7:1
K	20	14.0:1	14.7:1	14.7:1	14.7:1	14.7:1	15:1	15:1	15:1
P	10	14.0:1	14.7:1	14.7:1	15:1	15:1	15:1	15:1	15:1
A		Idle							Maximum

RPM

Turbocharged Piston Engines W/ Pent roof Combustion Chamber

Air/Fuel Ratio

L	300	13.0:1	12.5:1	12.2:1	12.2:1	12.2:1	12.2:1	12.2:1	12.2:1
O	275	13.0:1	12.8:1	12.5:1	12.5:1	12.2:1	12.2:1	12.2:1	12.2:1
A	250	13.0:1	12.8:1	12.5:1	12.5:1	12.2:1	12.2:1	12.2:1	12.2:1
D	225	13.0:1	12.8:1	12.8:1	12.8:1	12.5:1	12.5:1	12.5:1	12.5:1
	200	13.0:1	12.8:1	12.8:1	12.8:1	12.5:1	12.5:1	12.5:1	12.5:1
I	175	13.0:1	13.0:1	13.0:1	12.8:1	12.8:1	12.8:1	12.8:1	12.8:1
N	150	13.0:1	13.0:1	13.0:1	13.0:1	13.0:1	13.0:1	12.8:1	12.8:1
	125	13.0:1	13.0:1	13.0:1	13.0:1	13.0:1	13.0:1	12.8:1	12.8:1
K	100	13.0:1	13.0:1	13.0:1	13.0:1	13.0:1	13.0:1	12.8:1	12.8:1
P	75	14.0:1	14.2:1	14.2:1	14.2:1	14.2:1	14.2:1	14.2:1	14.2:1
A	50	14.0:1	14.7:1	14.7:1	14.7:1	14.7:1	14.7:1	14.7:1	14.7:1
	25	14.0:1	14.7:1	14.7:1	14.7:1	14.7:1	14.7:1	14.7:1	14.7:1

Idle

Maximum

RPM

The AFR is often referred to as a Lambda (λ) number. A Lambda of 1.00 is equal to the stoichiometric ratio for the reactants in a system. For our purposes, the stoichiometric ratio is the ratio for the amount of ANY fuel used in an internal combustion engine. With Lambda measurement, any number higher than 1.00 is considered lean (more air than necessary to react with the fuel) and any number lower than 1.00 is considered rich.

Although Lambda is the term most often used when working with O2 sensors, we will use AFR in this manual because it is the most common term used when referring to internal combustion engines. The following is a chart for converting Lambda values to AFRs.

Lambda to AFR conversion chart

Lambda	AFR	Lambda	AFR	Lambda	AFR	Lambda	AFR
1.3	19.03	1.14	16.69	0.98	14.35	0.82	12.00
1.29	18.89	1.13	16.54	0.97	14.20	0.81	11.86
1.28	18.74	1.12	16.40	0.96	14.05	0.8	11.71
1.27	18.59	1.11	16.25	0.95	13.91	0.79	11.57
1.26	18.45	1.1	16.10	0.94	13.76	0.78	11.42
1.25	18.30	1.09	15.96	0.93	13.62	0.77	11.27
1.24	18.15	1.08	15.81	0.92	13.47	0.76	11.13
1.23	18.01	1.07	15.66	0.91	13.32	0.75	10.98
1.22	17.86	1.06	15.52	0.9	13.18	0.74	10.83
1.21	17.71	1.05	15.37	0.89	13.03	0.73	10.69
1.2	17.57	1.04	15.23	0.88	12.88	0.72	10.54
1.19	17.42	1.03	15.08	0.87	12.74	0.71	10.39
1.18	17.28	1.02	14.93	0.86	12.59	0.7	10.25
1.17	17.13	1.01	14.79	0.85	12.44	0.69	10.10
1.16	16.98	1	14.64	0.84	12.30	0.68	9.96
1.15	16.84	0.99	14.49	0.83	12.15	0.67	9.81

Knock Sensor

The knock sensor is like a microphone mounted to the engine block that is used to detect combustion knock. Every engine is different with respect to the amount of noise it generates. In most production engines, the sensitivity of the knock sensor is based on an average noise profile generated during dyno testing. A knock sensor that has a slightly lower threshold of sensitivity to knock is used to compensate for variances in engine noise. When the engine makes noise in frequencies and amplitude higher than the baseline noise profile, the sensor senses knock and the ECU reduces ignition timing until the noise (knock) is suppressed. Engines that have knock sensors on them from the factory need to have the baseline noise profile recorded when setting up the AEM EMS.

Sensor Calibration

Calibrating Temperature Sensors

There are several methods for calibrating temperature sensors for automotive systems. The most commonly used method is the *Comparison Method* which utilizes two sensors: one of unknown quality (the sensor of interest) and one of reference or standard quality. Both sensors are subject to the same temperature environment and the temperature is cycled over the range of interest. The sensor calibration curve is modified during the controlled temperature sweep so the displayed temperature from the unknown sensor is the same as that of the reference sensor.

Air Temperature

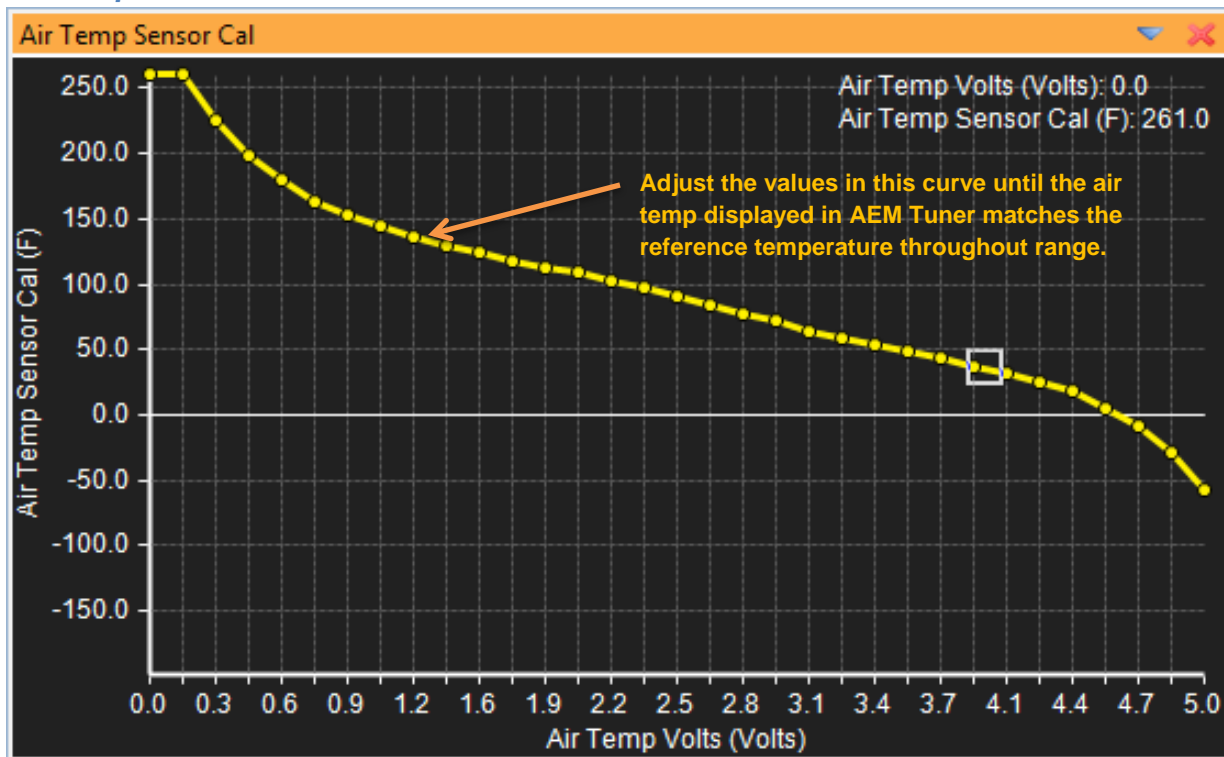

Name	Value	Unit
Air Temp Analog Inpu	Air Temp Volts	
Air Temp Fail Max	259	F
Air Temp Fail Min	-56	F
Air Temp Failsafe	77	F

Air Temp Analog Inpu(t) – Usually set to Air Temp Volts. Defines what pin the EMS expects to see the air temperature input on.

Air Temp Fail Max – If the air temperature exceeds this value the input will be considered in fail mode and the EMS will set the value to **Air Temp Failsafe**.

Air Temp Fail Min - If the air temperature falls below this value the input will be considered in fail mode and the EMS will set the value to **Air Temp Failsafe**.

Air Temp Failsafe – Default failsafe value for the air temperature input.

Air Temperature Setup Wizard

The setup wizard in AEM Tuner contains calibration settings for several different air temperature sensors.

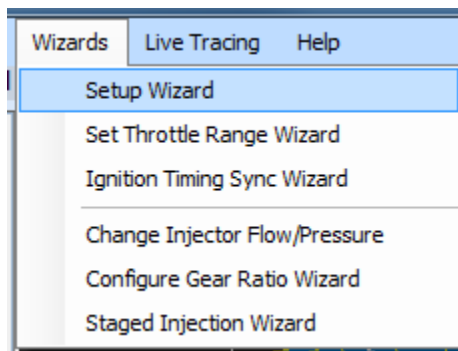

Go to the Wizards menu item and select Setup Wizard.

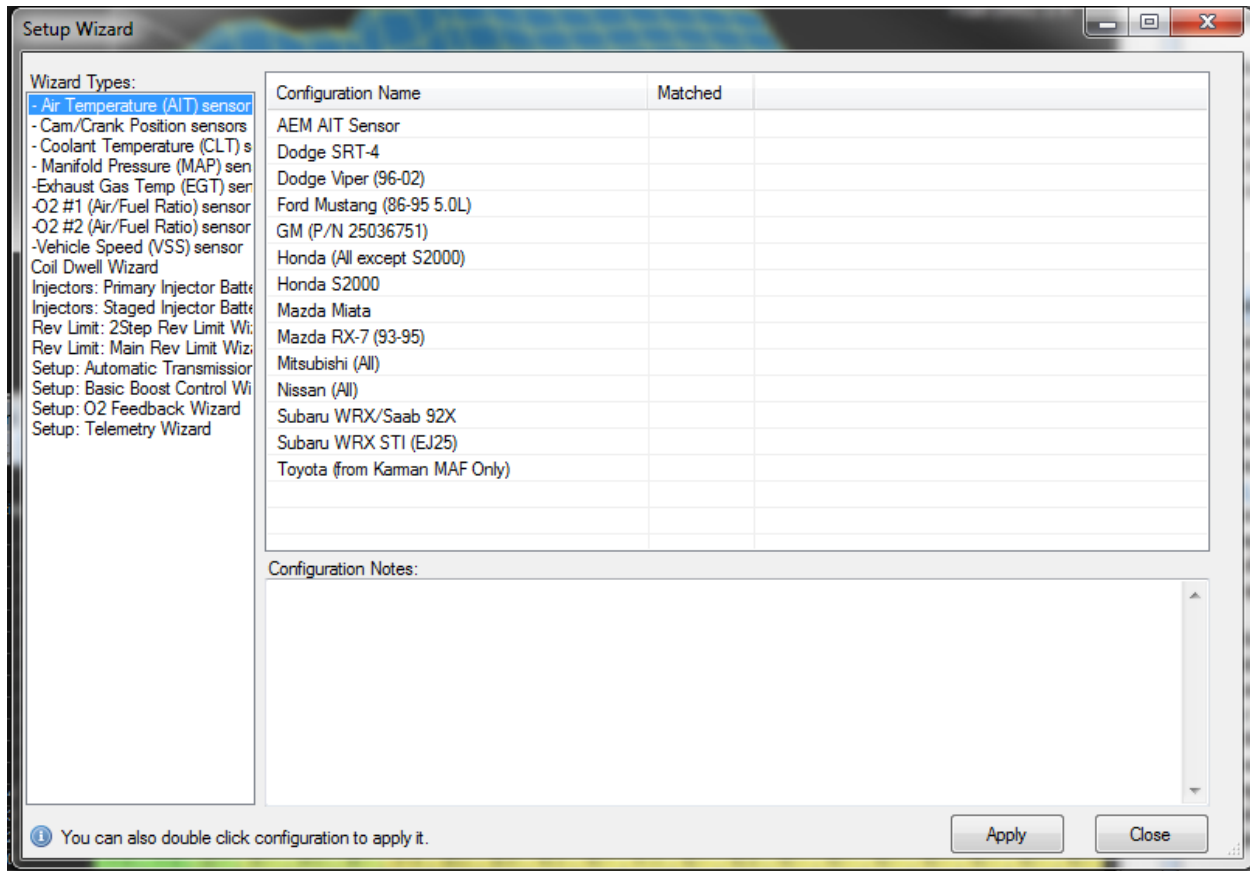

Choose the air temperature setup from the list and hit the Apply button. This will modify the settings defined above for the chosen sensor. **Please note that some amount of “fine tuning” to the calibration curve above may still be necessary especially if the EMS is installed in a “piggy-back” configuration with the factory ECU.**

Coolant Temperature

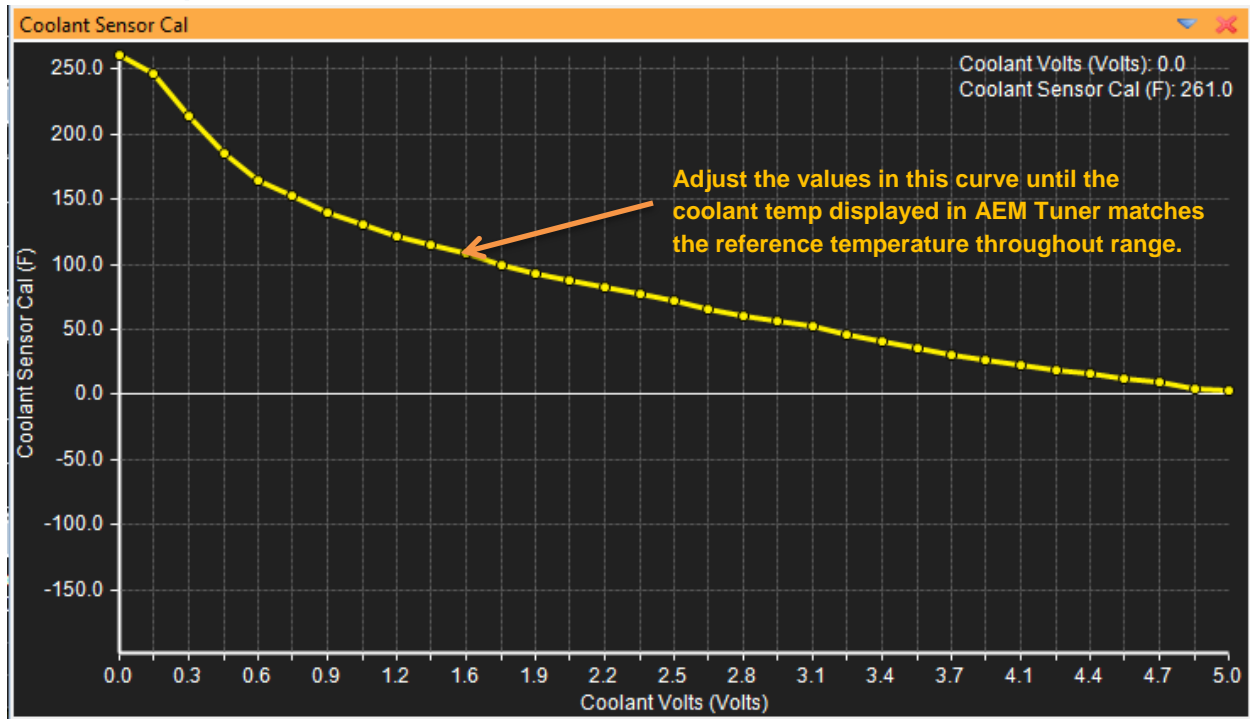

Name	Value	U...
Coolant Analog Input	Coolant Volts	
Coolant Fail Max	259	F
Coolant Fail Min	-9	F
Coolant Failsafe	176	F

Coolant Analog Input – Usually set to Coolant Volts. Defines what pin the EMS expects to see the coolant temperature input on.

Coolant Fail Max – If the air temperature exceeds this value the input will be considered in fail mode and the EMS will set the value to **Air Temp Failsafe**.

Coolant Fail Min - If the coolant temperature falls below this value the input will be considered in fail mode and the EMS will set the value to **Coolant Failsafe**.

Coolant Failsafe – Default failsafe value for the coolant temperature input.

Coolant Temperature Setup Wizard

The setup wizard in AEM Tuner contains calibration settings for several different coolant temperature sensors.

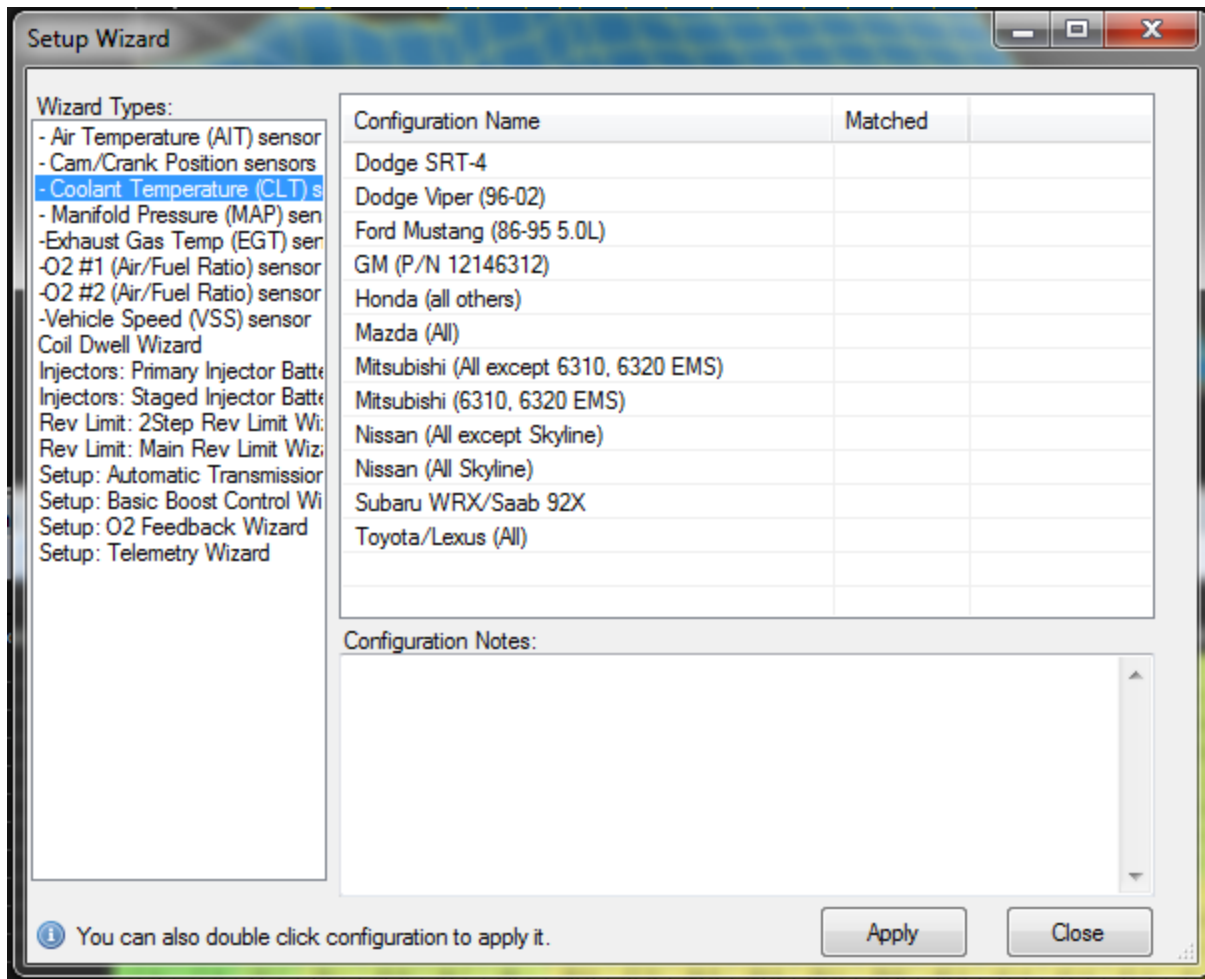

Choose the coolant temperature setup from the list and hit the Apply button. This will modify the settings defined above for the chosen sensor. **Please note that some amount of “fine tuning” to the calibration curve above may still be necessary especially if the EMS is installed in a “piggy-back” configuration with the factory ECU.**

Throttle Position Sensor Calibration

Set Throttle Range Wizard – The useable range for the TPS sensor must be defined in the calibration file accurately. The Set Throttle Range Wizard automates this process.

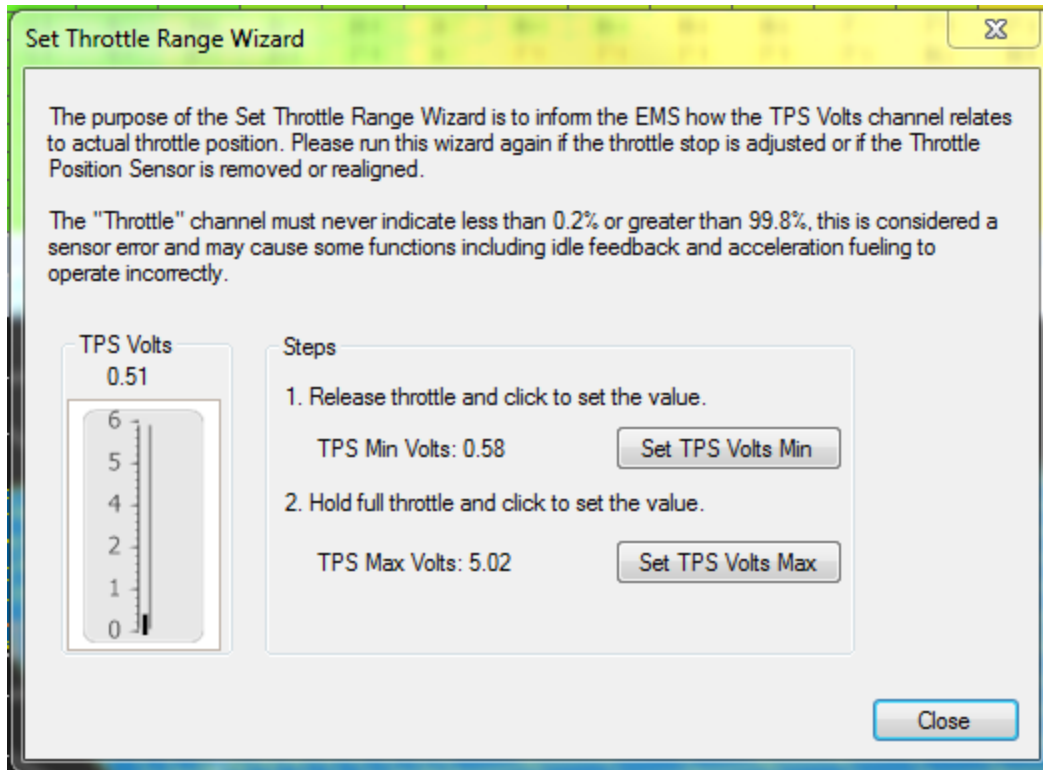

Set Throttle Range Wizard

The PC must be connected to the EMS. With the throttle in the full closed position, monitor the TPS Volts value in the window above. Minimum TPS voltage is usually 0.5 – 1.0 volts. Click the Set TPS Volts Min button. Next push the throttle to the wide open position. Monitor the TPS Volts value. Maximum TPS voltage is usually 4.0 to 4.5 volts. With the throttle held open, Click the Set TPS Volts Max button. Close the window. The throttle is now calibrated.

Manifold Pressure Sensor Calibration / Setup Options

Options - MAP Sensor		
Name	Value	Unit
MAP Analog Input	MAP Volts	
MAP Min Volts	0.5000	Volts
MAP Max Volts	4.5000	Volts
Load Offset	0.000	
Load Scalar	1.010	
MAP Filter	0	Teeth
Speed Density	ON	

Map Analog Input – The input pin defined for the MAP sensor input. Usually set to MAP Volts.

Map Min Volts - This is the value of the MAP signal in volts that corresponds with the minimum map value. This is the number that represents low manifold pressure (high vacuum) and will

vary based upon the MAP sensor used in the system. The load value of 0 displayed in AEM Tuner is determined by this setting.

Map Max Volts - This is the value of the MAP signal in volts that corresponds with the maximum map value. This number represents high manifold pressure (full throttle on a naturally aspirated engine or boost on a forced induction engine). This number varies based upon the MAP sensor used in the system. The maximum load value displayed in AEM Tuner is determined by this setting.

Load Offset - Offset used to scale engine load input away from the base 0-100% setting. Full Load scale = $100 * \text{Load Scalar} + \text{Load Offset}$. All load scales calculated here must be in kPa if you are using load units for the user selectable units to function.

Load Scalar - Scaler used to scale engine load input away from the base 0-100% setting. Full Load scale = $100 * \text{Load Scalar} + \text{Load Offset}$. All load scales calculated here must be in kPa if you are using load units for the user selectable units to function.

Map Filter - How many teeth pass to average the MAP sensor. A larger number filters the MAP sensor more.

Speed Density - This is the switch to use a MAP sensor as the primary load input with the system. If neither this nor the MAF option is selected, the load input will default to the Throttle position sensor.

Map Sensor Wizard

The setup wizard in AEM Tuner contains calibration settings for several different MAP sensors.

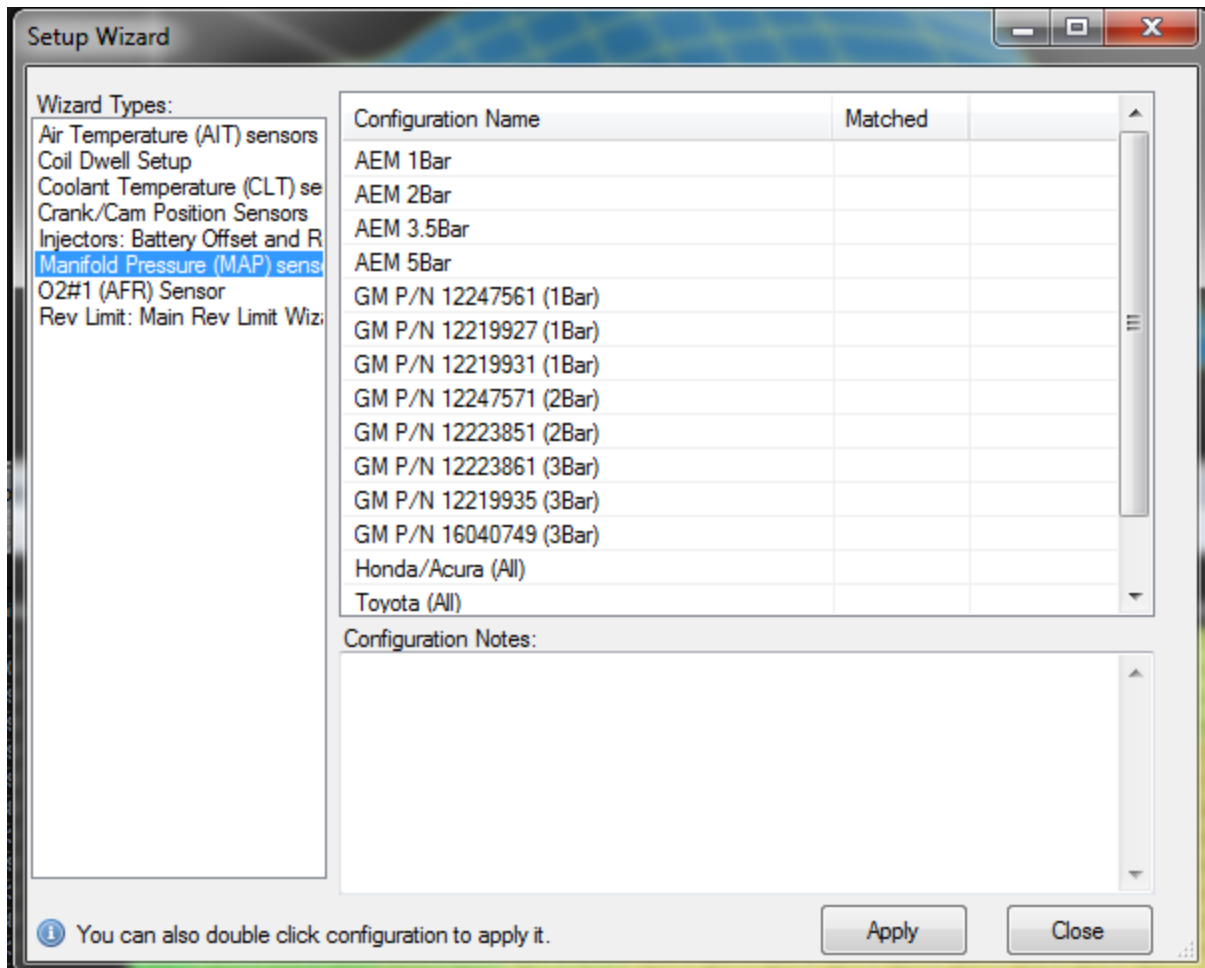

Choose the MAP sensor setup from the list and hit the Apply button. This will modify the settings defined above for the chosen sensor.

Fuel System Setup

Fuel Pump Setup

Any available GPIO pin can be used for the fuel pump control. Refer to the pinout sheet and schematic and choose an output pin. Go to the Tools menu item and select Configure Outputs to define the fuel pump configuration.

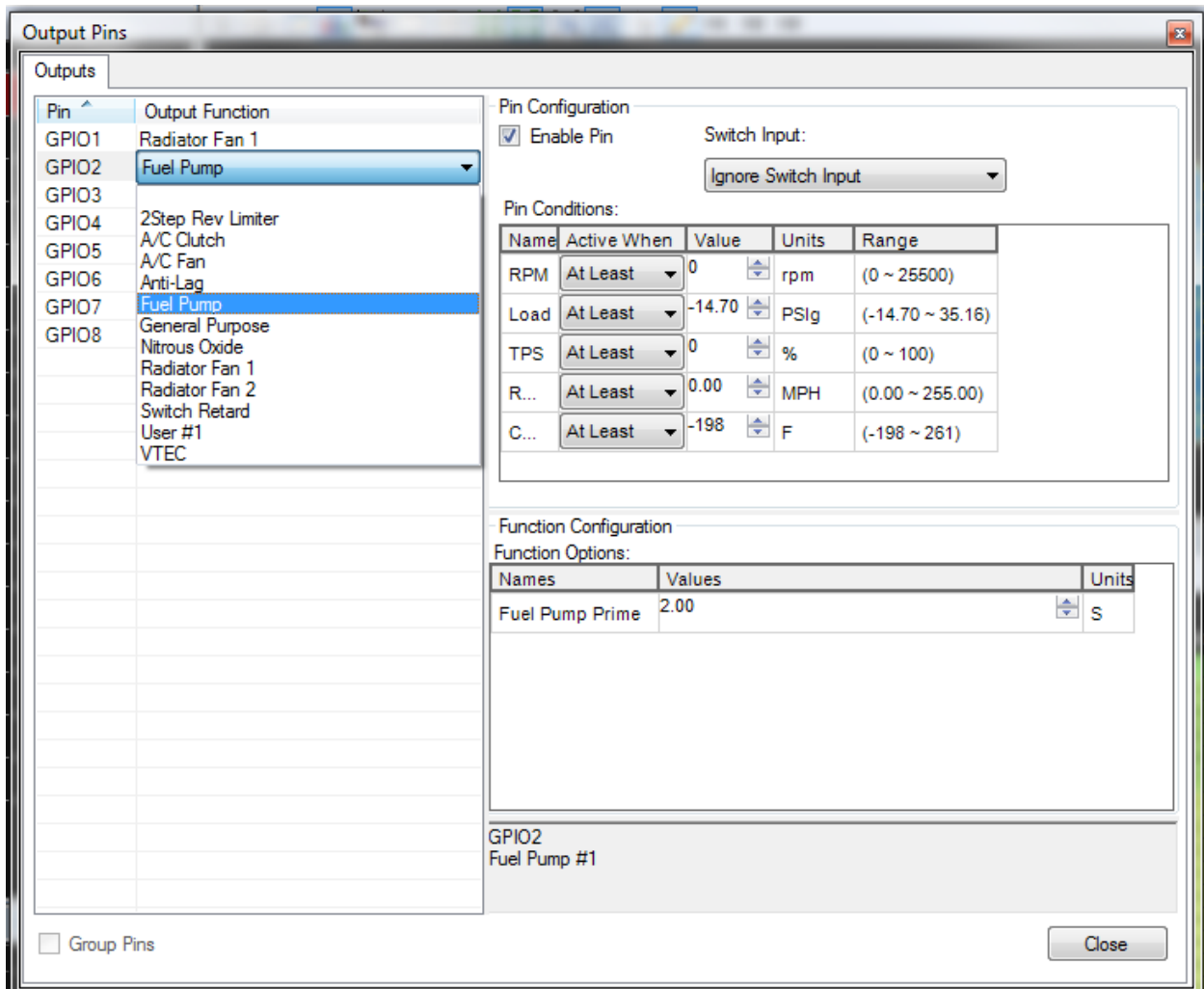
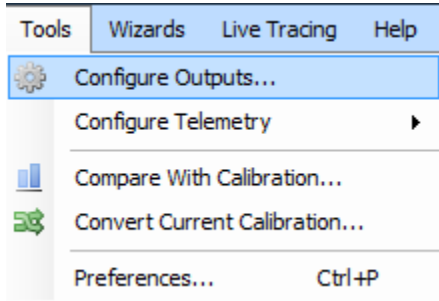

Double click the Output Function column next to the chosen GPIO pin. Select Fuel Pump. Activate the *Enable Pin* checkbox. Be sure the *Switch Input* is set to *Ignore Switch Input*. Pin conditions must be set such that they are met all the time. Define the required Fuel Pump Prime setting. At key on, the fuel pump output will activate for this amount of time then shut off if no engine RPM signal is detected.

Fuel Pump Sizing

To achieve proper fuel delivery, you must select the right fuel pump for your vehicle. In most cases, where the engine has been modified only with “bolt on” performance items, there is rarely need for a larger fuel pump or larger injectors. Vehicle manufacturers typically design a “safety factor” into the fuel pump to accommodate the deterioration of the fuel system over time. This safety factor is intended to compensate for a fuel filter that is nearing the end its life, or for deposits in the injector orifice. Our research has revealed that generally there is about a 15%-20% oversize in most factory fuel pumps.

If the engine is enhanced via forced induction or nitrous oxide, the stock fuel pump is inadequate. **If the engine’s power is increased more than 15-20% fuel delivery must increase as a factor of the power gain.**

The way to determine the proper-size fuel pump is based on the desired brake specific fuel consumption (BSFC) of the engine. This term refers to how much fuel in pounds per hour (pph) the engine consumes per horsepower and is a measure of the efficiency of the engine. It is a useful term in determining the total fuel requirement of the engine.

On vehicles equipped with forced induction or nitrous oxide, higher BSFC’s are required as an added measure of safety to prevent detonation or high combustion chamber temperatures. Below is a guide of BSFC’s with standard CR that AEM uses for various engines that run on gasoline:

- Naturally Aspirated engines have a BSFC of .48 to .50
- Forced Induction engines have a BSFC of .65 to .68

Methanol (alcohol) powered engines require twice the amount of fuel so the BSFC’s are doubled.

Calculating the total fuel requirement of an engine requires simple equations that we outline in the following section. You must know how much power the engine is anticipated to make and we recommend that you guess on the high end. The fuel requirement will be determined in pounds per hour of fuel flow. Since most pumps are rated in gallons/hour you must know the weight of your fuel/gallon. (The vast majority of gasoline based fuels run at 7.25 lbs./gallon.)

The equations to determine your fuel requirement is as follows:

- **(Power x BSFC) x (1 + Safety Margin) = pounds/hour**
- **Pounds/hour / 7.25 = gallons/hour.**

An example of this equation is:

- 500 hp gasoline engine using moderate boost with a 30% safety margin
- $(500 \times .625) \times 1.30 = 406.25 \text{ lbs./hr.}$
- $406\text{lbs}/7.25 = 56 \text{ gallons/hour.}$
- If the pump that is being considered is rated in liters per hour, use the conversion factor of 3.785/gallon. The pump described above would be rated at 56 gallons x 3.785 liters = 211.96 liters/hour.

In the fuel pump sizing, always use a safety margin greater than 20%.

Fuel Pump Location

The fuel pump should be located at a level that corresponds to the lowest part of the fuel tank. This does **NOT** mean that the pump should be in a vulnerable position such as hanging below the tank. The pump should also be positioned so that it is protected from the road hazards (speed bumps, curbs, road debris etc.). In the event of an accident, the vehicle structure around the fuel pump should not deform to a point where the pump and its electrical connections are compromised.

The wiring for the fuel pump **MUST** be rated for the amperage of the pump. As with all high current wiring, a fuse rated for the amperage of the pump should be used. It is always better to err on the large side for the wire size. The ground for the pump must be the same size as the power lead and be mounted to a location that is clean and clear of any undercoating or paint.

Fuel Hoses and Routing

Even with proper injector and fuel pump sizing, a fuel system will not flow adequately unless the hoses that deliver the fuel to the fuel rail are of sufficient size and are routed properly. On systems that use the PNP version of the AEM EMS, there is no need to replace the fuel delivery hoses unless the engine is heavily modified.

NEVER route fuel hoses through the interior of a car. Put bluntly, this is a **dangerous** thing to do. Whenever possible, use a delivery tube to make the connection from the pump discharge to the filter in the front of the car. The lines should be rated to withstand at least twice the maximum pressure of the EFI system.

Using the above parameters of our sample engine with moderate boost, we expect to see pressures in the 65-70 psi range. This will require a line with at least 140-psi rating (most AN hoses exceed this by a large margin). When routing fuel lines, it is imperative that they are protected from road hazards and the exhaust system. The fuel line should **NEVER** be routed

near battery cables. Use clamps to secure AN hose every 15 inches, or 24 inches if a rigid tube is used.

The following table will help you determine which hose size is correct for your application: These sizes are based on a nominal fuel pressure of 40 psi.

Fuel Delivery Hose Sizes

Gasoline Powered Engines

Up to 499 HP	.344" hose	-6AN
--------------	------------	------

500 - 799 HP	.437" hose	-8 AN
--------------	------------	-------

900 – 1100 HP	.562" hose	-10 AN
---------------	------------	--------

Methanol Engines

Up to 499 HP	.437" hose	-8 AN
--------------	------------	-------

500 - 799 HP	.562" hose	-10 AN
--------------	------------	--------

900 – 1100 HP	.687" hose	-12 AN
---------------	------------	--------

The above table should be used for typical passenger car applications. However, for custom applications the hose run length will affect fuel delivery. If you have a long hose run, then the actual flow will have to be determined by running the fuel pump into a graduated cylinder, then measuring the flow vs. time and calculating the flow in gallons per hour (g/h). Also note that if fuel banjos are used in the system be sure they have adequate fuel flow capability.

The fuel return hoses should be one size smaller than the delivery hose. For the sample engine described above, we would use a .437" (-8) delivery hose and a .344" (-6) return hose.

Fuel Filter and Fuel Rail

Often overlooked in EFI installations, the fuel filter must have the capacity, filtering efficiency and burst strength to withstand the pressures of an EFI system. It must be able to flow the

amount of fuel that matches the maximum fuel pump output. The filter is always located after the fuel pump, however it does not matter if it is positioned in the front or rear of the vehicle (we prefer to put it toward the front for easy serviceability). AEM carries fuel filters for high-powered engines, which use an easy to find, high volume, replaceable element.

It is imperative that a pre-filter be mounted to the fuel pick up in the tank. These filters are very high volume and create very little pressure drop. The use of a pre-filter ensures long fuel pump life and can eliminate low flow conditions caused by debris entering the pump inlet.

The final link in the fuel delivery system is the fuel rail. The fuel rail should be consistent with, or larger than, the hose size. The additional capacity of a large-diameter fuel rail helps to dampen the pulsations created by the fuel injectors and ensures even fuel delivery under all conditions.



Fuel Pressure Regulator and Pulse Dampener

The fuel pressure regulator maintains a constant pressure across the fuel injector. The inlet manifold pressure varies with throttle angle, and engine speed. Small throttle angles and high engine speed produce low manifold pressure (high vacuum). While high throttle angles and low rpm give high manifold pressure. In addition to these conditions, low manifold pressure is associated with idle and high manifold pressure is at full throttle. It is the fuel pressure regulators job to keep a constant fuel pressure across the injector(s) regardless of manifold pressure.

Currently, there are several types of fuel pressure regulators in use. Many late model cars use a return-less system where the fuel pressure regulator is mounted in the fuel tank adjacent to the fuel pump (and therefore requires no return line back to the fuel tank). In most naturally aspirated applications these types of systems are adequate. With forced induction or heavily modified engines, an adjustable fuel pressure regulator with manifold vacuum reference must be fitted.

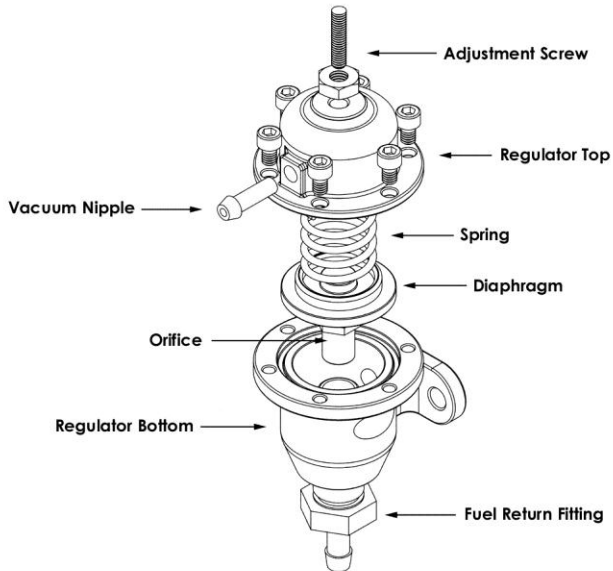

The two common types of fuel pressure regulators used are non-adjustable and adjustable. As the name implies, a non-adjustable regulator is set at a fixed value and is manifold-vacuum referenced (whenever a regulator is said to be vacuum referenced, this means that the inlet manifold vacuum/pressure is ported into the chamber above the regulator diaphragm).

As manifold pressure increases, the pressure in the top chamber of the pressure regulator increases along with it, allowing the regulator to compensate for the increased demand of the fuel delivery system.

Keep in mind that at idle or low throttle openings with high rpm, there is very low manifold pressure (vacuum). This tends to literally draw fuel from the injector. As manifold pressure increases (as the throttle is opened), this vacuum dissipates and it is harder for the fuel to discharge from the injector. The regulator reacts to the differences in manifold pressure to maintain constant fuel pressure across the injector. There is a spring in the vacuum (top) chamber of the fuel pressure regulator. The spring's pressure on the diaphragm determines the fuel system's static pressure. The system's static pressure is the amount of pressure measured with the vacuum hose disconnected or with the engine turned off. The fuel system's static pressure is higher than the fuel pressure at idle or under high vacuum conditions.

When the engine is running, the engine vacuum acts against the spring and the effect of the vacuum diminishes as the throttle is opened. At idle, there is a high amount of fuel returned to the tank because the vacuum is pulling the diaphragm seat off of the fuel return orifice, reducing fuel pressure. As the throttle is opened, the diaphragm seat starts to close off the orifice, restricting the amount of fuel flow through the return line.

An adjustable regulator allows the static pressure to be raised or lowered via an adjusting screw that acts on the diaphragm spring. On most adjustable regulators, when the screw is turned **in** pressure raises and when it is turned **out** pressure is reduced. Although we highly recommend installing a proper fuel delivery system, raising or lowering fuel pressure *can* compensate for fuel injectors that may not be properly sized for an application.

Most aftermarket fuel pressure regulators (and OE regulators) use a 1:1 ratio of fuel to boost pressure for increasing fuel pressure in applications where forced induction is used. This means that for every psi of boost, fuel pressure is increased one psi. This ensures adequate fuel delivery under boosted conditions.

Many vehicle manufacturers use a pulse dampener to reduce the pulsations in the fuel rail caused by the opening and closing of the injectors (a dampener also reduces the noise of the injectors). In applications where a new fuel system must be installed, a fuel pressure dampener is integral to ensuring consistent fuel flow to the injectors. AEM fuel rails have a provision for a pulse dampener. The dampener assembly part numbers are:

Honda PN:	16680-PE7-661	Dampener
Honda PN:	16705-PD1-003	Inner Gasket
Honda PN:	90428-PD6-003	Outer Gasket
AEM PN:	2-602	Fitting for Rail

Before the fuel system is assembled in the vehicle, inspect for debris and damages. Before the fuel system is checked make sure to have a fire extinguisher near by in case of fire. After the fuel system is installed you must inspect the integrity of the entire system. Begin by purging the lines. To do this, run the fuel pump with the hose that connects to the fuel rail placed in a grounded container. This will eliminate any debris left in hose during its manufacturing process. Inspect the fuel rail for cleanliness before starting the engine. Make sure that the fuel pressure is set correctly for your application. Then, reattach all of the hoses and run the fuel pump by switching the ignition to the "ON" position (**DO NOT** turn over the engine at this time), and visually inspect all of the connections for fuel seepage or leaks. If any seepage or leaks are present in the system, repair them before proceeding.

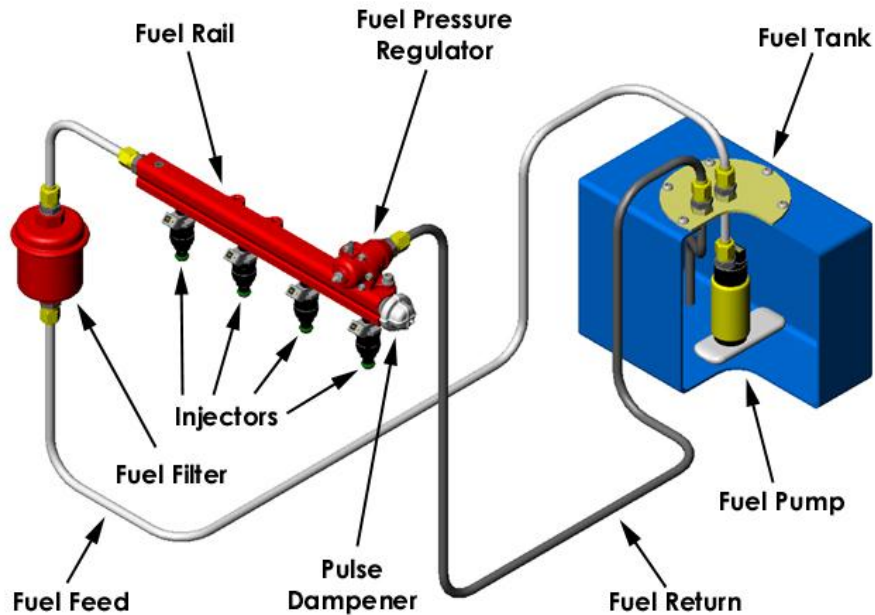

Basic Tuning

Timing Pickup Confirmation

The *Timing Pattern Basics* section above presented a brief overview of how the options and tables in AEM Tuner are used to configure a calibration for use with a certain timing pattern. This section will describe how to confirm the EMS is receiving the proper timing pattern information before attempting to start the engine for the first time.

For this test it is important to disconnect the following items:

- ***All fuel injectors***
- ***All ignition coils***
- ***Remove the fuel pump relay or fuse to disable pump function***

At this point, we do not want the engine to try and start. We want to confirm proper timing pattern inputs only.

Name	Value	Unit
Engine Speed	104	rpm
Cam Count	107	
Crank Count	55	
Stat Sync'd	ON	
Crank Tooth Period	46.9	mS
A Tooth	49	
Fuel Tooth	9	
Cam Tooth	0	
Sync Errors	0	
Timing Errors	1	

The screen capture above shows a list of basic timing pattern channels. There are many others but this list will allow the tuner to confirm the basics. Verify proper main battery power and ground connections and turn the ignition switch to ON. Connect to the EMS with AEM Tuner and crank the engine with fuel injectors, ignition coils and fuel pump disabled. View or log the channels in the list above.

Engine Speed – Calculated engine speed. Should not be zero during cranking. Confirm reasonable data. Cranking speed can be anywhere from 100 to 300 RPM and depends on many variables such as: battery voltage, starter type and condition, engine displacement, compression ratio, etc. A value of 0 for engine speed during cranking means an error in the timing pattern setup, a sensor error or a wiring error.

Cam Count – Increments by one every time a cam sync tooth edge is detected by the ECU. Value will count from 0 – 255 and reset. This channel will remain zero unless there edge selection options turned on for the cam sensor input such as:

Name	Value	Unit
Cam HALL Falling Edg	OFF	
Cam HALL Rising Edge	ON	
Cam MAG Falling Edge	OFF	
Cam MAG Rising Edge	OFF	

Crank Count – Increments by one every time a crank tooth edge is detected by the ECU. Value will count from 0 – 255 and reset. This channel will remain zero unless there edge selection options turned on for the cam sensor input such as:

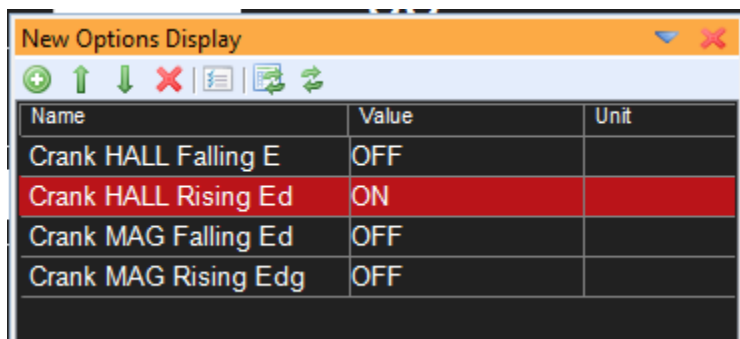

Name	Value	Unit
Crank HALL Falling E	OFF	
Crank HALL Rising Ed	ON	
Crank MAG Falling Ed	OFF	
Crank MAG Rising Edg	OFF	

Stat Sync'd – Turns ON when synchronization criteria are met. This channel should be off when the engine is not cranking. It should turn ON during cranking and depending on the timing pattern, it may take up to two engine revolutions. If it remains OFF during cranking or flickers OFF/ON, there is an error in the timing pattern setup, a sensor error or a wiring error.

Crank Tooth Period – The measured time in milliseconds between crank tooth edges.

A Tooth – See Tooth Control Table description in *Timing Pattern Basics* section above.

Fuel Tooth – Increments when the ECU detects a “Fuel Tooth” edge. See *Timing Pattern Basics* section.

Cam Tooth – Increments when the ECU detects a “Sync Tooth” edge. See *Timing Pattern Basics* section.

Sync Errors – Increments when a sync error is detected. Note that sync errors are normal for certain timing patterns. See *Timing Pattern Basics* for more information.

Timing Errors – Increments when the ECU sees the wrong number of fuel teeth between sync teeth. A small number of timing errors is normal during cranking but this channel should not continue to increment during normal cranking or running conditions.

The following PC log example data was collected running a 60-2 crank trigger pattern with 12 fuel teeth and no sync teeth. Note the Crank Tooth Period “bumps” when the ECU detects the missing tooth section. A larger value for period corresponds to a larger distance between edges.

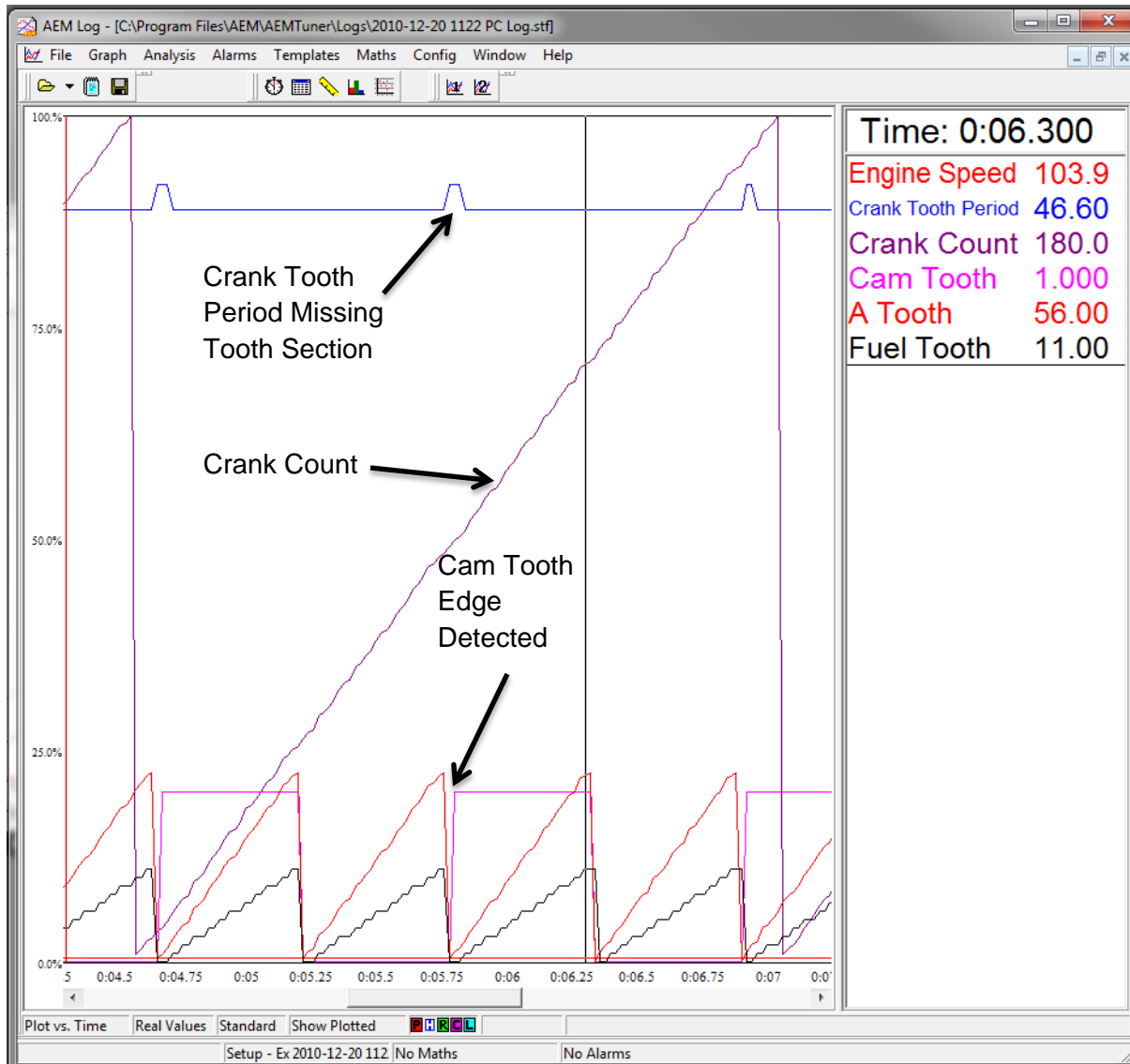

The A Tooth channel counts from 0 to 57 then resets. The Fuel Tooth channel counts from 0 - 11 then resets (one loop through the tooth control table or 12 edges). A simple PC log like this recorded during cranking can be very helpful in troubleshooting timing pattern problems.

Noise

Electrical noise can cause the EMS to see more tooth edges than there are in reality. This will result in excessive "Timing Errors" during cranking or constant errors during normal running. Misfire caused by "noise," (commonly referred to as radio frequency interference {RFI}, or electro magnetic interference {EMI}), is usually due to routing the input signal leads in close proximity of the HT leads. Typically, spark plug wires cause RFI or primary ignition wires arcing to an engine component, which causes a frequency that interferes with the ECU. Routing two wires that carry high current parallel to each other cause EMI. The strength of current necessary to incur "noise" is dependent on the sensitivity of the device the wires are connected to. A

common preventative measure for eliminating “noise” is to twist the wires together to minimize the electromagnetic field near the wires.

On any EFI system, resistive spark plug leads are REQUIRED to suppress noise!

Common resistive spark plug leads include those with a carbon impregnated fiberglass core or spiral wound filament around a carbon core wire.

Another source of noise that can cause a misfire is an electrical “leak” in a plug wire or boot. Even a very small pinhole in a spark plug insulator or boot will allow electricity to arc to the cylinder head and interfere with the ECU signal.

When the timing pattern inputs are correct, it’s time to move on to ignition synchronization.

Ignition Synchronization

The ignition timing measured with a timing light must be synchronized with the displayed value in AEM Tuner. This is one of the most important steps in the setup process. Without it, the commanded ignition timing may not be accurate.

It’s a good idea to disable the fuel injectors and/or fuel pump during this step as well. Until the timing is sync’d, it doesn’t make any sense to inject fuel just to fire it at the wrong time. The ignition coil(s) must be connected and in working order.

Ignition Timing Sync Wizard

Go to Wizards – Ignition Timing Sync Wizard. The purpose of the Timing Sync Wizard is to synchronize the actual ignition timing with the value commanded by the EMS.



Ignition Timing Sync Wizard

The PC must be connected to the EMS and the engine must be running. To minimize ignition timing fluctuation, the timing from the EMS can be locked at a given setting. Select or type in a value then click the *Lock Ignition Timing at* checkbox. Next measure the ignition timing at the balancer with a timing light and compare the actual reading to the commanded “locked” value. If they differ, use the Advance or Retard Timing buttons to adjust the actual value until it matches the locked timing value. Perform this procedure during cranking then re-check it after the engine is up and running.

Crank Fuel & Engine Start

Typical Start Setup Tab

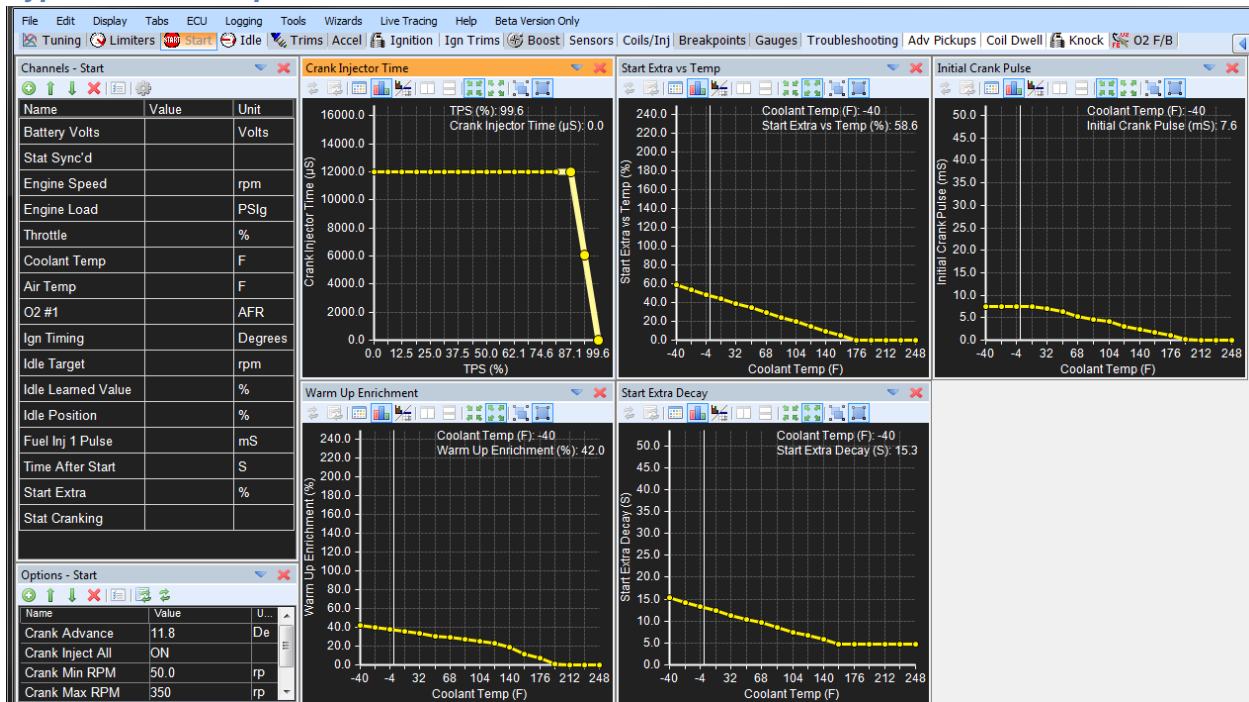

Crank setup options

Crank Advance – Desired ignition timing during cranking conditions

Crank Inject All – When selected, all injector outputs will fire at the same time and inject fuel using the pulsewidth values defined in the **Initial Crank Pulse** table.

Crank Min RPM – The minimum engine speed before fuel and spark events are allowed. Typically set to 50 RPM.

Crank Max RPM – The maximum engine speed for cranking fuel and spark values. Varies but usually set to 300 – 500 RPM.

2D Tables for Engine Start

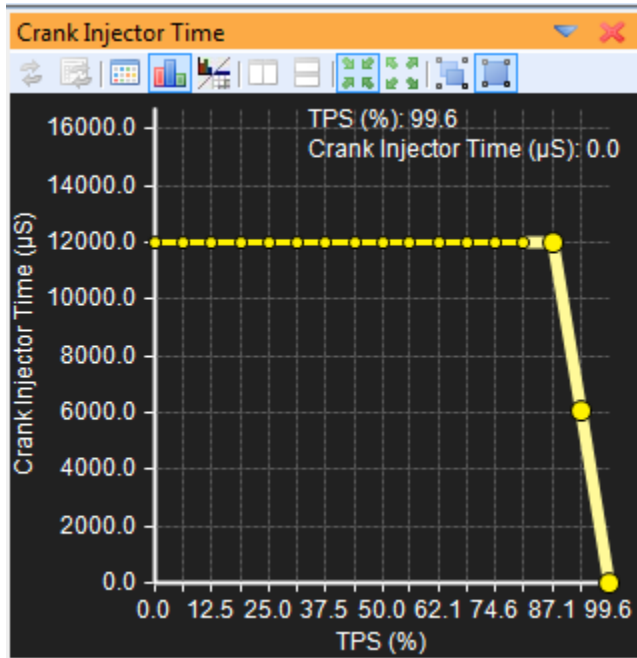

The **Crank Injector Time** table is the base commanded value for crank fuel. X-axis is throttle position. In the example above, the crank injector time is minimized at wide open throttle to serve as a flood clear mode.

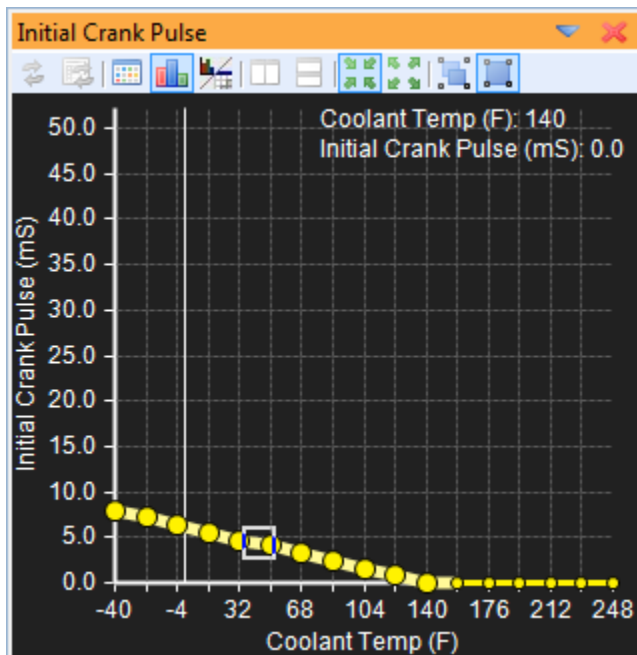

The **Initial Crank Pulse** table is a one shot pulse applied to all injectors when the EMS first detects a crank tooth edge.

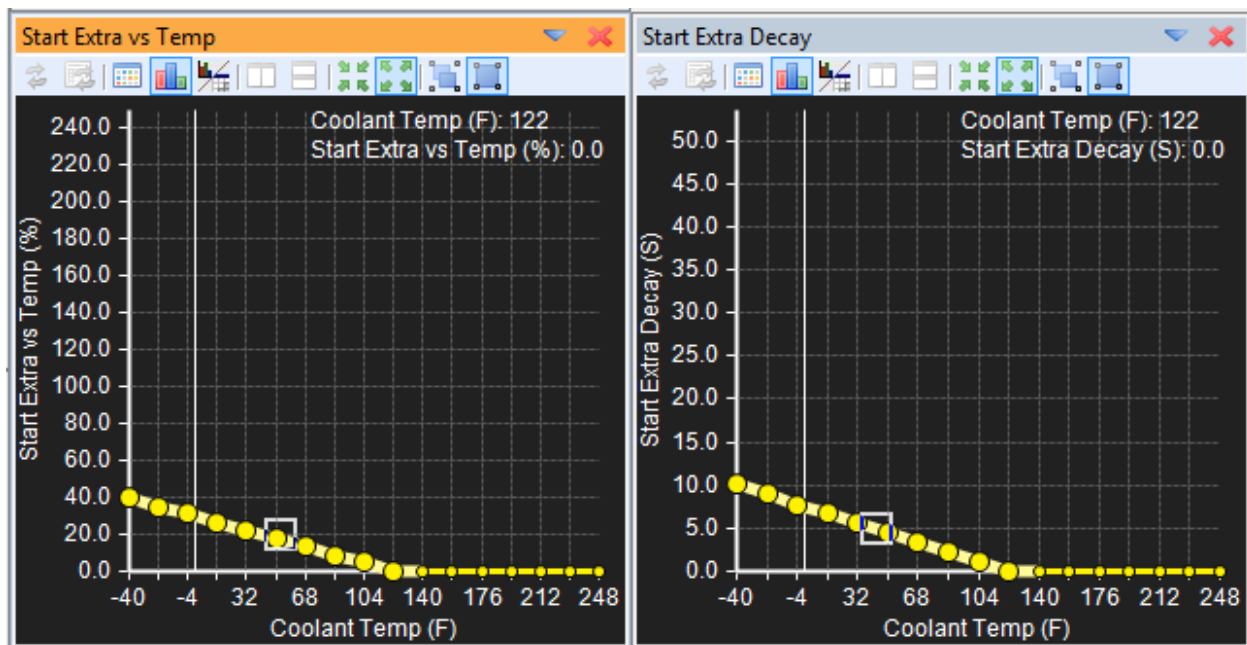

The **Start Extra vs Temp** and **Start Extra Decay** tables work together. Both are vs coolant temperature. An enrichment is applied from the **Start Extra vs Temp** and decays away according to the time defined in the **Start Extra Decay** table.

Idle Air Control

Idle air control (IAC) systems are used to stabilize idle speed during cold engine and after warm-up operations. The IAC system regulates the volume of air bypassed around a closed throttle butterfly valve. The EMS controls the IAC system by applying various input signals from the user-programmable software file. There are two major types of IAC systems. The stepper idle air control motor is, typically used by Toyota, Dodge, Mitsubishi, etc. The pulse width idle air control valve is commonly used by Honda, Subaru, Ford, Nissan, Volkswagen, etc. **EMS-4 systems are only compatible with pulse width (PWM) style control valves.**

The pulse width duty cycle valve regulates air bypass volume by utilizing a duty cycle controlled solenoid. This electric solenoid controls an air valve which blocks passage of air from the intake pipe to the intake manifold. Since this solenoid is incapable of flowing high air volume, a separate mechanical air valve is typically used to perform cold fast idle. With this type system, the EMS varies bypass airflow by changing the duty ratio of the command signal to the IAC valve. By increasing the duty ratio, the EMS holds the air bypass valve open longer, causing an increase in idle speed.

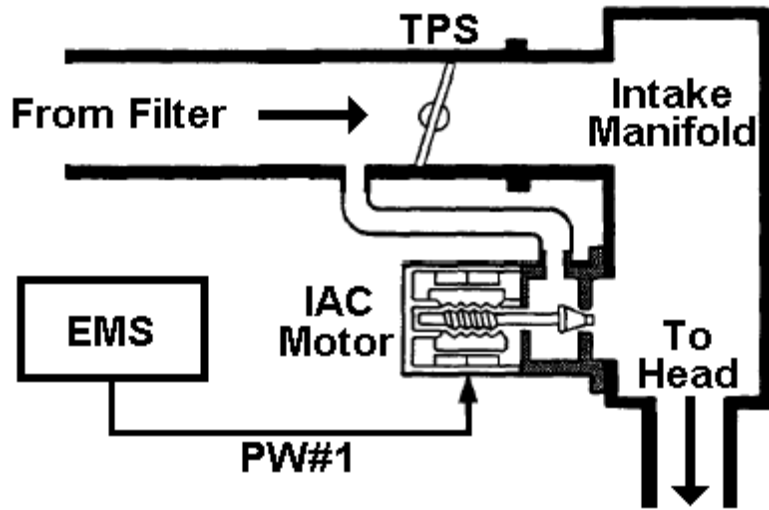

Typical Idle Setup Tab

AEMTuner v2.5 - C:\Program Files\AEM\AEMTunerBeta\Calibrations\AEM20\ DAN RUNNING 5.AEM20.01X19.cal

File Edit Display Tabs ECU Logging Tools Wizards Live Tracing Help Beta Version Only

Tuning Limiters Start Idle Fuel Trims Accel Ignition Ign Trims Boost Adv Boost Sensors Coils/Inj Breakpoints Gauges Troubleshooting

Channels - Idle		
Name	Value	Unit
Idle Target		rpm
Engine Speed		rpm
Engine Load		PSig
Throttle		%
O2 #1		AFR
O2 #1 FB Value		%
Coolant Temp		F
Ign Timing		Degrees
Idle Base		%
Idle Learned Value		%
Idle Error Duty		%
Idle Position		%

Options - Idle		
Name	Value	Unit
Idle FB Above RPM	400	rpm
Idle FB Below RPM	2000	rpm
Idle On If TP Less	3.9	%
Idle Off If TP Over	3.9	%
Idle FB Min	-14.8	%
Idle FB Max	30.1	%
Idle FB Dead Band-	-25	rpm
Idle FB Dead Band+	50	rpm
Idle P Gain	0.88	
Idle FB Rate	201.0	mS
Idle PW Frequency	8196.8	µS
Idle PW Output	GPIO5	

Options - AC Idle Trim		
Name	Value	Unit
A/C Idle Load Comp	0.0	%
A/C On Delay	0.00	S

Options - Idle Trims		
Name	Value	Unit
High Idle Above VSS	5	MPH
High Idle RPM Offset	200	rpm
High Idle Wait Time	2.0	S

Idle% vs Target		
Idle Target (rpm)	Idle% vs Target (%)	Idle Target Base (rpm)
2600	74.6	1475.0

Idle Target Base		
Coolant Temp (F)	Idle Target Base (rpm)	
-40	1475.0	
248	~800	

Options - AC Idle Trim		
Name	Value	Unit
A/C Idle Load Comp	0.0	%
A/C On Delay	0.00	S

Ign vs Idle RPM		
Idle Target Error (rpm)	Ign vs Idle RPM (Degrees)	
300	-11.3	

RPM Offset vs TPS		
Throttle (%)	RPM Offset vs TPS (rpm)	
0	1050.0	
10	~100	

RPM Offset vs Start		
Time After Start (S)	RPM Offset vs Start (rpm)	
0	1050.0	
32	~100	

A/C On Delay, Units: Seconds - Description: The time between when the A/C request is switched ON and the A/C compressor is turned ON. Used to open the idle motor slightly before the increased load from the A/C compressor to counter-act idle surge.

A/C Idle Load Comp, Units: Idle % Description: Amount of extra duty required to maintain the existing target RPM when the A/C compressor is enabled. The value can be positive or negative depending on how the idle air control motor responds. A typical value is (+/-) 5. Encourages a stable idle when the A/C is switched ON and is used in conjunction with the **A/C On Delay** option.

Hi Idle RPM Offset, Units: RPM - Description: Additional RPM added to the idle target when in the "high idle" condition. Typically used for engine deceleration to help prevent engine stalling.

Hi Idle Above VSS, Units: Vehicle Speed. Description: When above this speed, the high idle condition will be maintained indefinitely. The vehicle speed sensor must be set up for this function to work. Typically used for engine deceleration to help prevent engine stalling.

Hi Idle Wait Time, Units: Seconds - Description: Counter limits how long the high idle offset conditions will be met once the idle conditions are met. Typically used for engine deceleration to help prevent engine stalling.

Idle FB Below rpm, Units: RPM Description: Maximum RPM threshold for closed loop idle feedback. A typical value is 1700 RPM. Stalling can occur if this RPM value is too high. This stalling is typically caused from driving slow enough to never exit the closed loop idle condition. The idle air control motor will completely close in attempt to bring the idle to the target value and cannot react and open fast enough if the user lets off the throttle for an idle state. A steady "open loop" high idle can occur if this RPM value is too low. This is caused from the base idle speed (Idle% vs Target table) never dropping below the Idle FB Below rpm condition.

Idle FB Above rpm, Units: RPM Description: Minimum RPM for closed loop idle feedback. The lowest idle speed possible that should mimic the Crank Exit RPM. A typical value is 400 RPM. Open loop idling can occur if this value is too large where the idle air control motor does not respond. If the Engine RPM goes below this value, idling will be solely dependent on the Ign Timing and Fuel Inj Base Pulse parameters.

Idle PW Frequency, Units: uS, Description: For pulse width idle air control motors only. Defined as a "Frequency" but as specified, the value is actually a "period". Frequency and Period are related by the equation:

Frequency (Hz) = 1 / Period (seconds)

One uS or microsecond = 1×10^{-6} seconds

Sets a frequency that is specific to the idle pulse width motor being used. If the idle air control motor is noisy or has a lazy response, the frequency should be changed. **Typical frequency values for most OEM idle air control valves are 100 – 300 Hz.**

100 Hz = 10,000 μ S

300 Hz = 3333 μ S

Idle FB Max, Units: Idle %, Description: Maximum air bypass percentage allowed to maintain the target idle. A typical value is 15%. Before tuning the idle option, this value may need to be large in order to stabilize idle for normal tuning. After tuning idle, it is a good idea to narrow the feedback range to eliminate unwanted idle changes.

Idle FB Min, Units: Idle %, Description: Minimum air bypass percentage allowed to maintain the target idle. A typical value is -5%. Before tuning the idle option, this value may need to be a large negative number in order to stabilize idle for normal tuning. After tuning idle, it is a good idea to narrow the feedback range to eliminate unwanted idle changes.

Idle FB Dead Band-, Units: RPM, Description: Disables idle correction below the target idle speed. A typical value is - 25. This function is very useful if exact idle speeds are not crucial, but reasonable stable speeds are. If this value is too large, stalling may occur due to low idle speeds.

Idle FB Dead Band+, Units: RPM, Description: Disables idle correction above the target idle speed. A typical value is 50. This function is very useful if exact idle speeds are not crucial, but reasonable stable speeds are. If this value is too large, high idling may occur due to open loop feedback.

Idle FB Rate, Units: mS, Description: Idle air control feedback time base. Time allowed for an idle air control motor to respond and make decisions for idle feedback. This function determines how often the engine RPM is referenced for closed loop feedback in order to make adjustments and maintain the Idle Target. Decreasing this number speeds decision making but may cause the idle control to "hunt". Increase this number to the largest value that can still accurately control the idle. If the idle motor responds slowly to RPM variations off the Idle Target, then decrease this number. If hunting or surging occurs, increase this number. A typical value is 200mS.

Idle On If TP Less, Units: Throttle %, Description: Throttle dependent idle feedback. Idle feedback is active when throttle percentage is below this number. This number should be the same or smaller than the **Idle Off If TP Over** option. A typical value is 3. In order for idle feedback to be active, make sure this value is larger than your Throttle parameter during an idle state.

Idle Off If TP Over, Units: Throttle %, Description: Exit of throttle dependent idle feedback. Idle feedback is disabled when the throttle percentage is above this number. This value also determines the reinstatement of idle feedback. This number should be the same or larger than the **Idle On If TP Less** option.

Idle PW Output, Drop Down List, Use to select the desired PWM idle control output pin. For EMS-4 applications, only GPIO 5 – 8 can be used for duty cycle control. See pinout sheet or schematic for more information.

2D Idle Control Tables

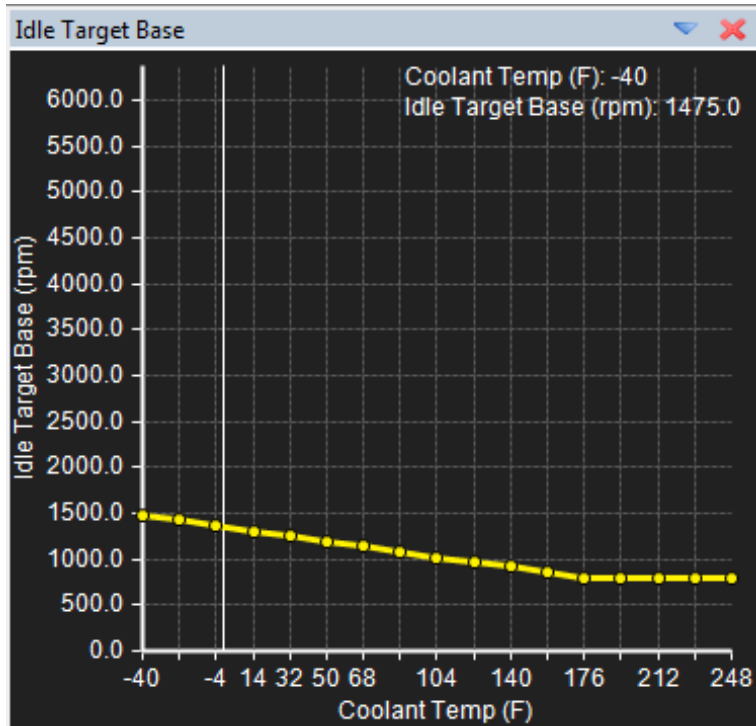

The **Idle Target Base** table is used to set the desired engine idle speed vs coolant temperature. Typically, slightly higher target values are used at colder engine temperatures as shown in the example above.

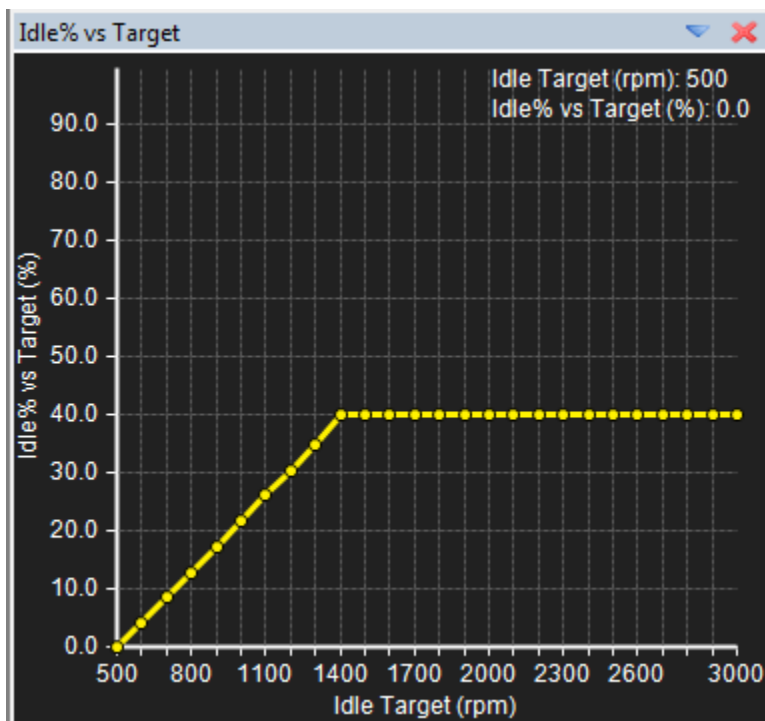

The **Idle % vs Target** table is used as the open loop set point vs target RPM. When entering into the idle control function, the ECU will command the output duty cycle to the value defined in this table. For example, using the table above if the current idle target is 1400 RPM, the ECU will command an IAC duty cycle of 40% then check to see if the actual engine speed is equal to the target RPM. If it is, no changes are made. If it is not, the ECU will adjust from this point.

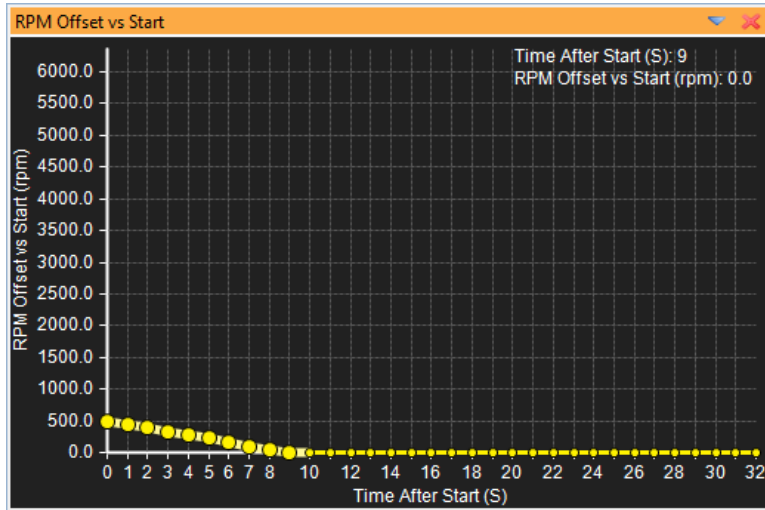

The **RPM Offset vs Start** table is used to add an extra amount of idle air bypass immediately after starting. This extra amount is decayed over a period of time defined in this table. In the example above, an offset of 500 RPM will be added to the base target value and this extra amount will decay over a period of 10 seconds. If the base target was 1000 RPM, the ECU will target 1500 RPM at first then control the RPM down to 1000 after 10 seconds. This RPM flare will help the engine transition from crank/start to normal idle smoothly.

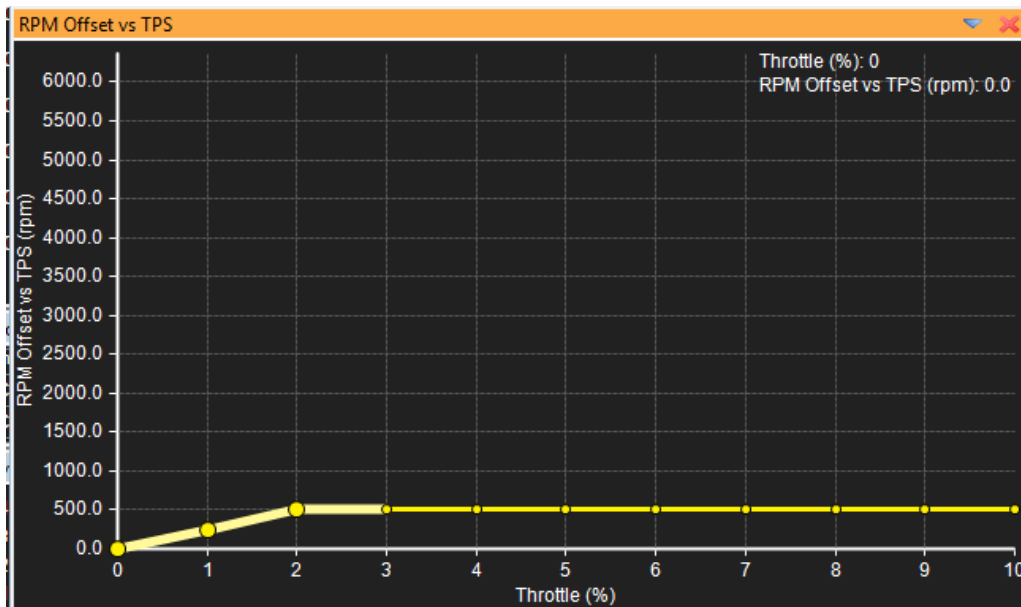

The **RPM Offset vs TPS** table or “Throttle Follower” table is used to keep the idle control system from fighting the driver command during very light throttle applications like creeping in traffic. Sometimes very light throttle application by the driver will not make the TPS % exceed the value set for the **Idle Off if TP Over** option. When this happens the ECU will try to close the IAC valve to keep the idle speed at the target. This can cause a sluggish feel to the engine. This table can be used to add additional air bypass as the throttle is opened slightly to account for this condition.

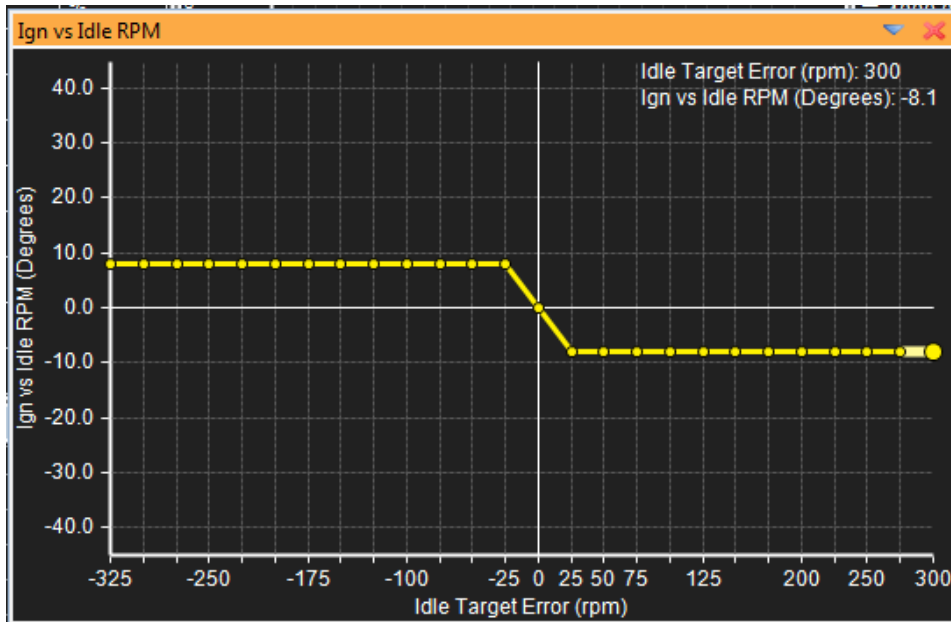

The **Ign vs Idle RPM** table can be used to allow ignition timing to help control idle. If the actual engine speed is below the target, this table can add timing. If the actual engine speed is above the idle target, this table can subtract timing. Some OEM ECU’s use this method and refer to it as “Idle Spark Scatter” because the ignition timing will fluctuate rapidly up and down as the ECU uses it to help control idle speed.

Idle Channels

Idle Target Units: RPM, Description: This is the final idle target RPM that the IAC motor is attempting to achieve after all idle compensators.

Idle Target Error Units: RPM, Description: RPM value above or below the Idle RPM Target value.

Idle Base Units: %, Description: Percent of idle control motor position generated from the Idle% vs Target table.

Idle Position Units: Idle %, Description: Final compensated idle air bypass percentage.

Idle Learned Value Units: Idle %, Description: The idle percentage above or below the target idle. Zero percent would represent no correction to the IAC motor to achieve the target idle.

High Idle RPM Offset Units: RPM, Description: The additional amount of RPM added anytime the system goes into idle control. The RPM is added for the length of time specified in the Hi Idle Wait Time option. This function is also used anytime the car is below the High Idle Above VSS Value.

Idle RPM Trim Start Units: RPM, Description: Additional RPM added when the engine starts. Uses the RPM Offset vs Start table to determine decay time.

Ign Trim Idle Units: Ignition Degrees, Description: Additional amount of ignition timing added or subtracted that comes directly from the Ign Offset vs RPM table during idle condition.

Idle Tuning Procedure

The first step before tuning the IAC system is to determine the direction of the motor. The language of the IAC motor is in percentage. This is not percent open or percent of airflow, it is rather the full-scale percentage of the motor where 100% may be fully closed or fully open. Do not assume that a larger idle percent gives a higher idle speed. Some factory units actually decrease Engine RPM as idle percentage increases. It is very easy to determine which way your specific IAC system works.

- Open AEM Tuner and connect to the EMS.
- Confirm that the throttle position is set properly (closed < 1%, WOT > 95%).
- Confirm the AFR or that the vehicle has sufficient fuel for idling and that the vehicle is at the normal operating temperature.
- Open the **Idle Tab** and set **Idle FB Below rpm** to a conservative 3,000RPM and set **Idle FB Above rpm** to 400RPM. Set both **Idle On If TP Less** and **Idle Off If TP Over** to a conservative 5%.

These settings will activate the idle circuit whenever the engine RPM is below 3,000 RPM and the throttle is below 5%. These settings are not necessarily drivable but they will allow the vehicle to idle on its own so you can begin tuning.

- Start the engine.
- Get the vehicle to idle. This may require creative throttle movements to stabilize the idle until it catches itself.
- Confirm that an increase in the **Idle% vs Target Table** will increase RPM rises.
- If RPM decreases, select the **Idle Invert** option.
- Shut off the engine.

Now that you know how the IAC motor responds, you can start setting up the idle tables and idle options.

- In the **Idle Tab**, set the option **Idle FB Min** to -50% and **Idle FB Max** to 50%.
- Set the options **Idle FB Dead Band+** and **Idle FB Dead Band-** to 0.
- Open the **Idle Tab** and set the entire **Idle Target Base table** to

- 3,000RPM.
- Start the engine.
 - After a few seconds, confirm that the **Idle Target** parameter is 3,000RPM (if not zero-out all).
 - Add or subtract idle percent from the **Idle% vs Target Table** until the **Idle Learned Value** parameter is 0% (you may notice that the idle motor will not rev the engine this high but that is common).
 - Drop the **Idle Target Base table** to 2900RPM.
 - Add or subtract idle percent from the **Idle% vs Target Table** until the **Idle Learned Value** parameter is 0%.
 - Drop the **Idle Target Base table** to 2800RPM.
 - Repeat this process for every 100RPMs until 500RPM is reached.
 - Set the **Idle Target Base table** to your desired values.

It is a good idea to set the **Idle FB Minimum** option to a small feedback percentage to keep the engine from stalling (5% is typical). The **Idle FB Maximum** can be set high to band aid tuning flaws (15% is typical). The **Idle FB Dead Band-** option is typically set at -25RPM while the **Idle FB Dead Band+** is typically set at +50RPM to keep the idle steady. A typical **Idle FB Below rpm** is 1700 which keeps the idle motor from trying to idle at slow vehicle speeds. Set both **Idle On If TP Less** and **Idle Off If TP Over** options 1% higher than the **Throttle** parameter when the engine is running and the throttle is at rest.

Fuel Tuning

The **Fuel Map** is the main fueling table in the calibration.

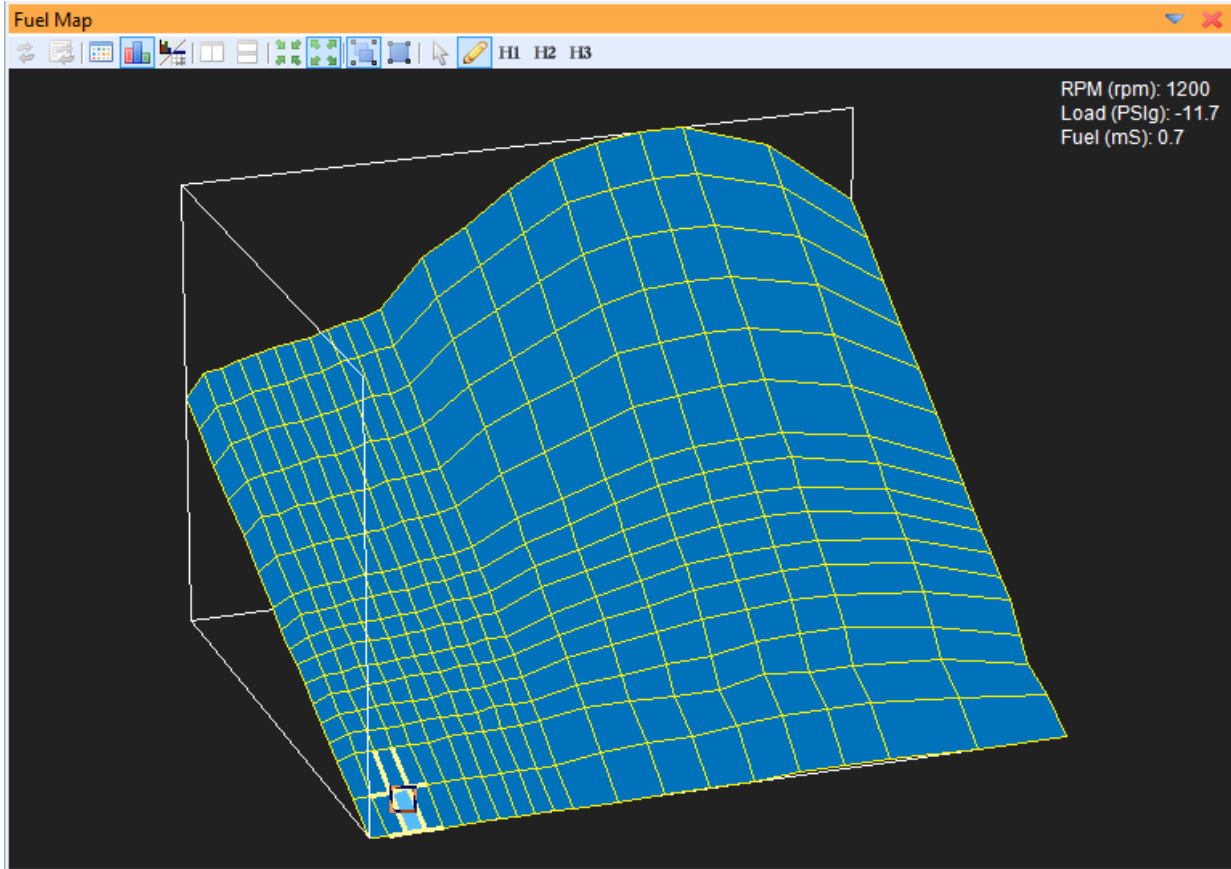

		RPM (rpm)																
Fuel (mS)		800	1000	1200	1400	1600	1800	2000	2200	2400	2600	2800	3000	3500	4000	4500	5000	5500
Load (PSig)	-0.1	5.1	5.6	5.6	5.8	5.8	5.9	6.0	6.0	6.2	6.2	6.3	6.4	7.3	7.9	8.5	9.0	9.2
	-1.0	4.8	5.2	5.2	5.4	5.4	5.5	5.6	5.6	5.8	5.8	5.9	6.0	6.8	7.3	7.9	8.4	8.5
	-1.9	4.4	4.8	4.9	5.0	5.1	5.1	5.1	5.2	5.3	5.4	5.4	5.5	6.3	6.8	7.2	7.7	7.9
	-2.9	4.1	4.4	4.5	4.5	4.6	4.7	4.7	4.7	4.9	4.9	4.9	5.1	5.7	6.1	6.6	7.0	7.2
	-3.9	3.7	4.0	4.0	4.1	4.1	4.2	4.3	4.3	4.4	4.4	4.5	4.5	5.2	5.6	5.9	6.3	6.4
	-4.9	3.3	3.5	3.6	3.7	3.7	3.7	3.8	3.8	3.9	3.9	4.0	4.1	4.6	4.9	5.2	5.6	5.7
	-5.8	3.0	3.1	3.2	3.3	3.3	3.3	3.3	3.4	3.5	3.5	3.5	3.6	4.1	4.3	4.6	4.9	5.0
	-6.3	2.7	3.0	3.0	3.0	3.1	3.1	3.1	3.1	3.2	3.2	3.3	3.3	3.7	4.0	4.3	4.5	4.7
	-6.9	2.5	2.7	2.8	2.8	2.8	2.8	2.9	2.9	3.0	3.0	3.0	3.1	3.5	3.7	3.9	4.1	4.3
	-7.3	2.4	2.5	2.6	2.6	2.6	2.6	2.7	2.7	2.8	2.8	2.8	2.8	3.2	3.4	3.6	3.8	3.9
	-7.8	2.2	2.3	2.3	2.4	2.4	2.4	2.4	2.4	2.5	2.5	2.6	2.6	2.9	3.1	3.3	3.5	3.5
	-8.3	2.0	2.1	2.1	2.2	2.2	2.2	2.2	2.2	2.3	2.3	2.3	2.4	2.6	2.8	3.0	3.1	3.2
	-8.8	1.8	1.9	1.9	2.0	2.0	2.0	2.0	2.0	2.0	2.0	2.1	2.1	2.4	2.5	2.6	2.8	2.8
	-9.3	1.6	1.7	1.7	1.7	1.7	1.8	1.8	1.8	1.8	1.8	1.8	1.8	2.0	2.1	2.2	2.2	2.4
-9.8	1.4	1.5	1.5	1.5	1.5	1.5	1.6	1.6	1.6	1.6	1.6	1.6	1.8	1.8	1.7	1.7	1.9	
-10.7	1.0	1.0	1.0	1.1	1.1	1.1	1.1	1.1	1.1	1.1	1.1	1.1	1.2	1.3	1.3	1.4	1.4	
-11.7	0.7	0.7	0.7	0.7	0.7	0.7	0.7	0.7	0.7	0.7	0.7	0.7	0.7	0.7	0.7	0.7	0.7	

The X-axis of the fuel map is engine RPM. The Y-axis is engine load. The values within the table are injector pulsewidth in milliseconds where 1000 milliseconds = 1 second.

Fuel Map Operating Areas

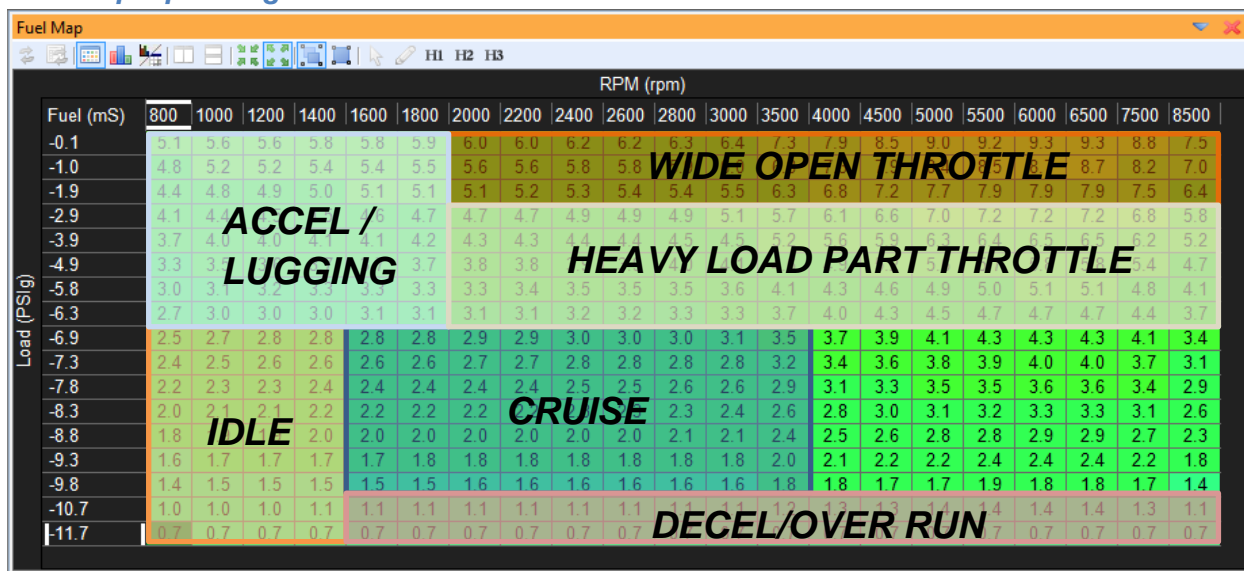

Every engine is different but in general the main fuel and ignition maps can be broken up into areas of operation as shown above.

Idle – Where an engine spends 99% of its time.

Accel / Lugging – The area of the fuel map accessed briefly during snap accelerations. Also the area used during lugging conditions in high gear.

Wide Open Throttle – Area accessed during wide open throttle operation.

Heavy Load Part Throttle – High load part throttle acceleration.

Cruise – Light load cruise conditions.

Decel / Over Run – High vacuum and high RPM condition. Generally accessed with vehicle in-gear going downhill.

Fuel Trims

The EMS has many available trims for fuel. The following section will describe each.

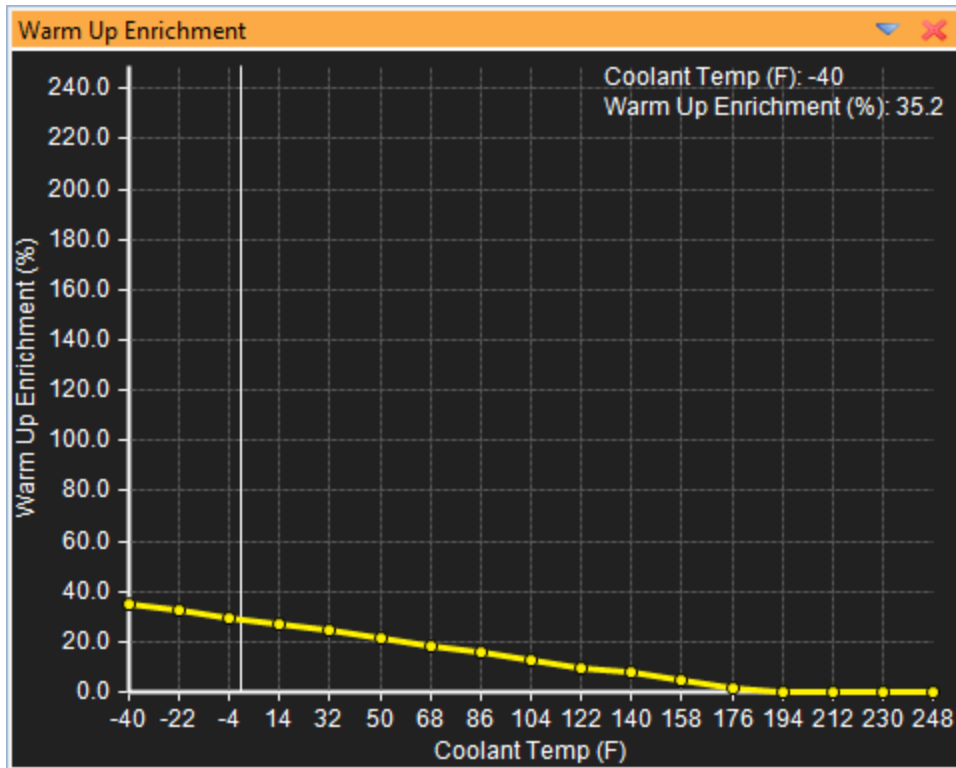

The **Warm Up Enrichment** table is used to compensate for poor fuel atomization during cold start conditions. Note that “cold start” does not necessarily mean frigid arctic conditions. It applies to any condition when the engine is not up to normal operating temperature. Additional fuel is needed just after start and before the engine reaches normal temperature.

Tuning Tip - *When creating a new tune from scratch. Leave the warmup enrichment table zero'd out at first. Start the engine and modify the main fuel map on the fly as the engine warms up. From this point forward, only make adjustments to the main fuel map when the engine is up to temperature. The next day, start the engine and monitor the AFR as the engine warms up. Adjust the Warm Up Enrichment table on the fly as the engine is coming up to temperature.*

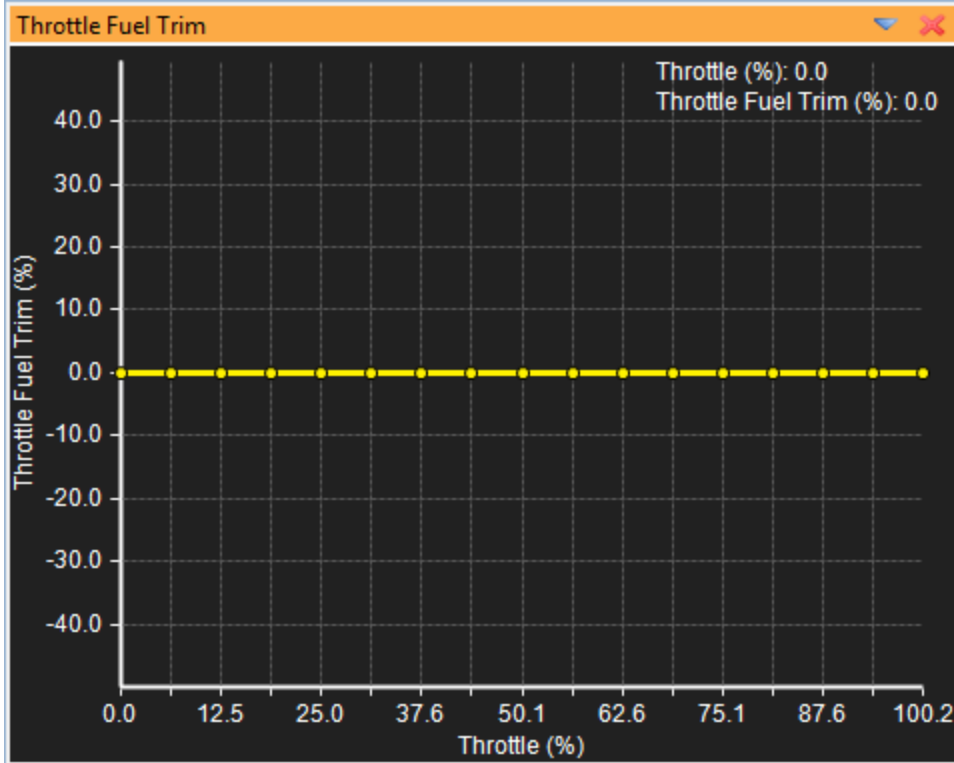

The **Throttle Fuel Trim** can be used to add a +/- fuel trim vs throttle position.

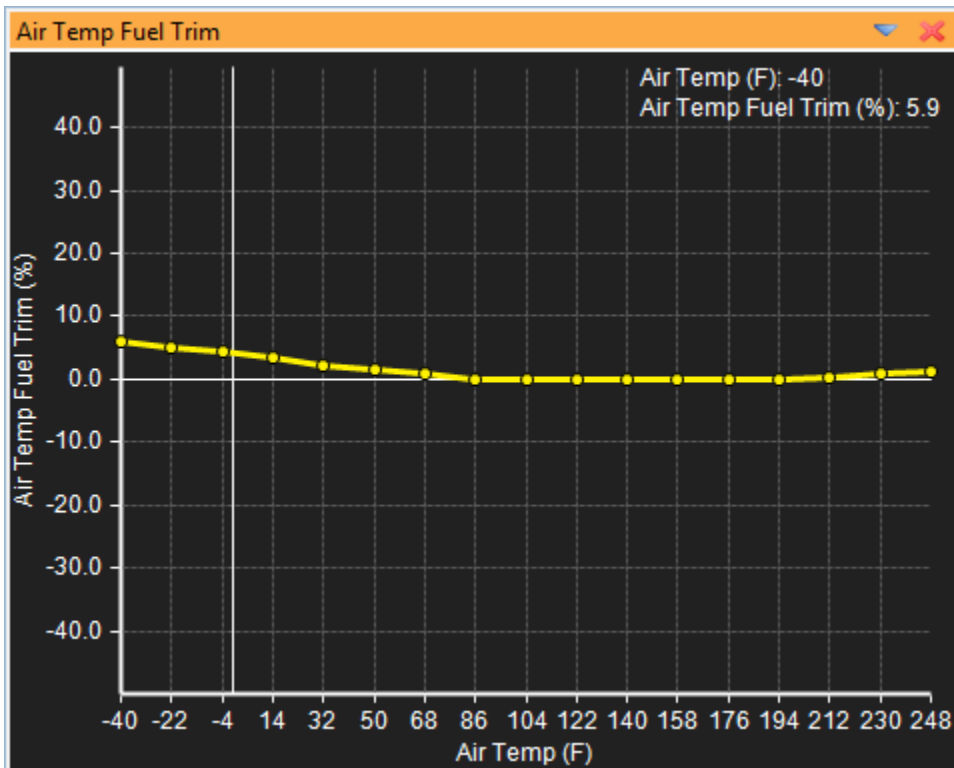

The **Air Temp Fuel Trim** table is used to compensate for air density changes with inlet air temperature. It can also be used in a safety mode to add additional cooling fuel at very high inlet air temperatures on boosted applications.

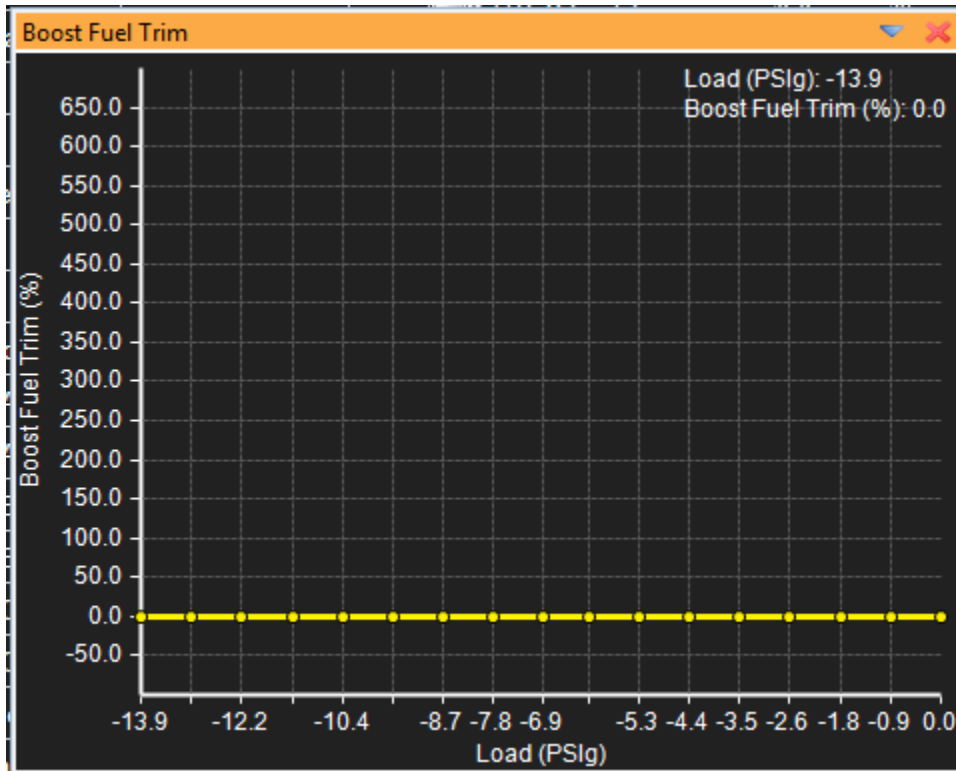

The **Boost Fuel Trim** table is used to add a fuel compensation vs engine manifold pressure. This table can be used in a number of ways. It can be used to compensate for boost pressure on a calibration file set up in Alpha-N mode or throttle based fueling or it can be used on a file set up using manifold pressure as the primary load input.

Tuning Tip - The **Boost Fuel Trim** table can be used to simplify the main fuel map tuning under boosted conditions. As a rule of thumb, 100% additional fuel compensation can be added for every additional Bar of boost pressure as shown in the image below:

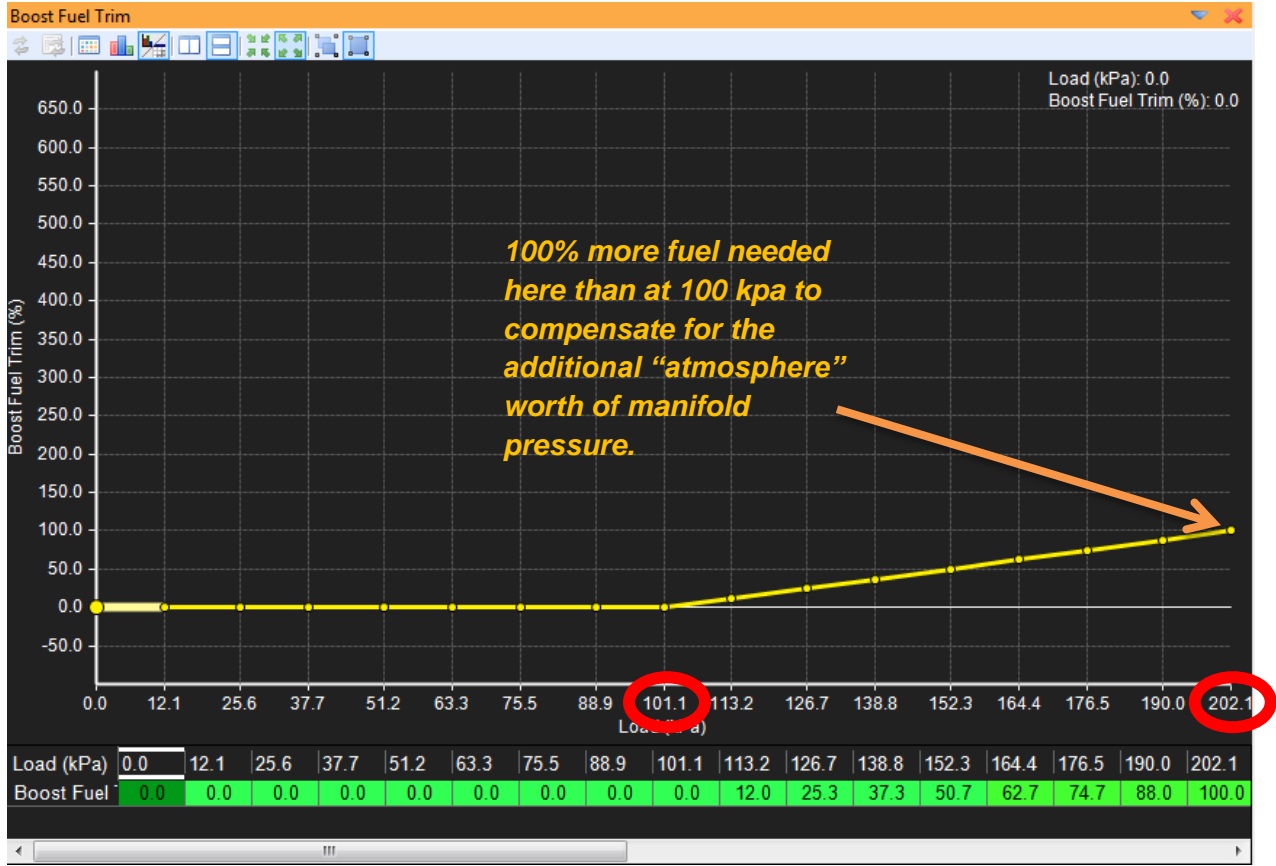

A 100% trim will effectively double the fuel flow. The Main Fuel Map can then be configured to maintain the same target pulsewidth vs engine pressure. It will only vary vs engine RPM as shown below:

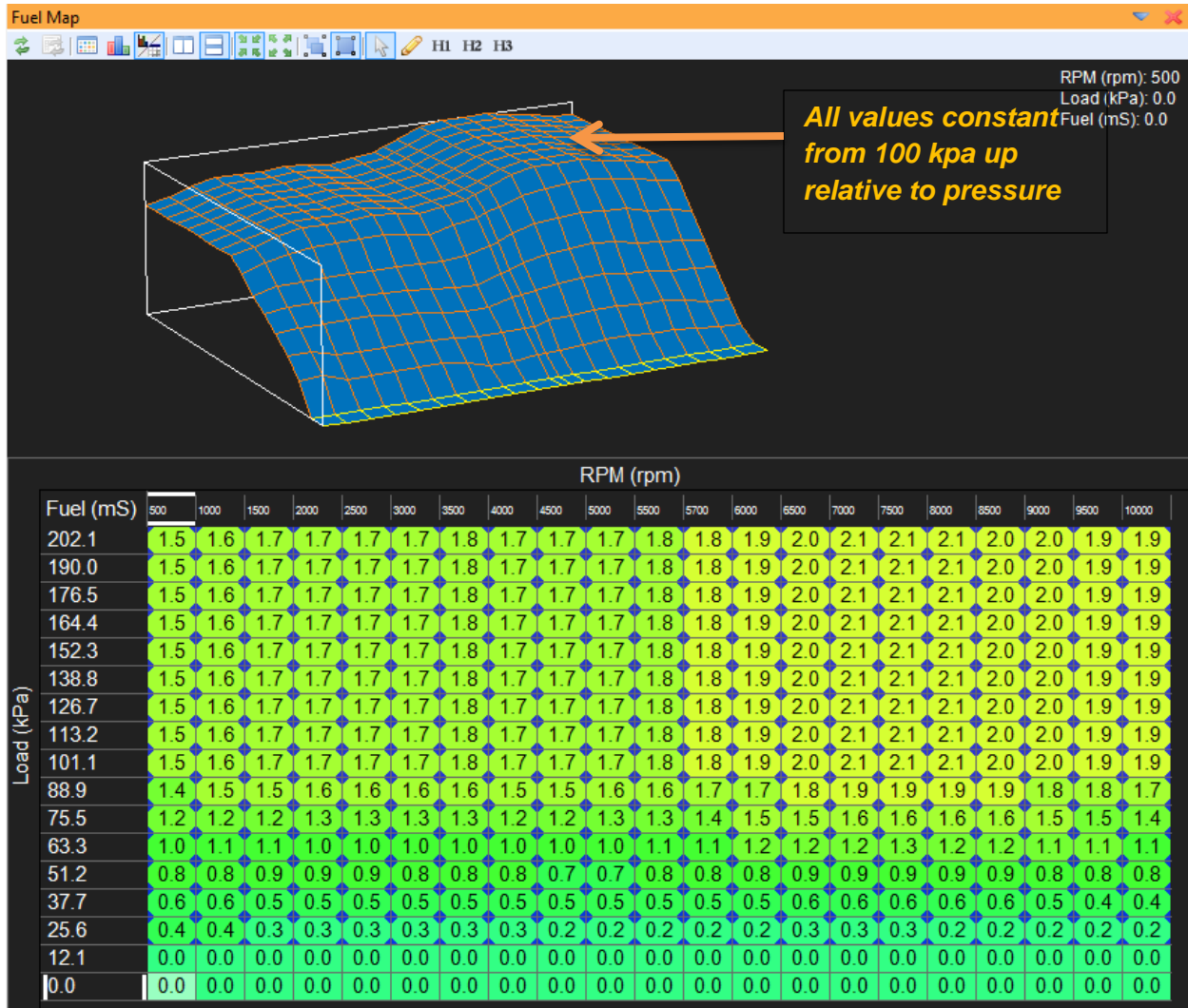

WOT throttle tuning can be accomplished very quickly using this method as you only have to worry about tuning vs engine RPM and not engine load. Complete your test run, dyno pull, etc. and review the AFR data. To make changes over a specific RPM range, highlight the range as shown and increase or decrease as necessary to enrichen or lean the fuel.

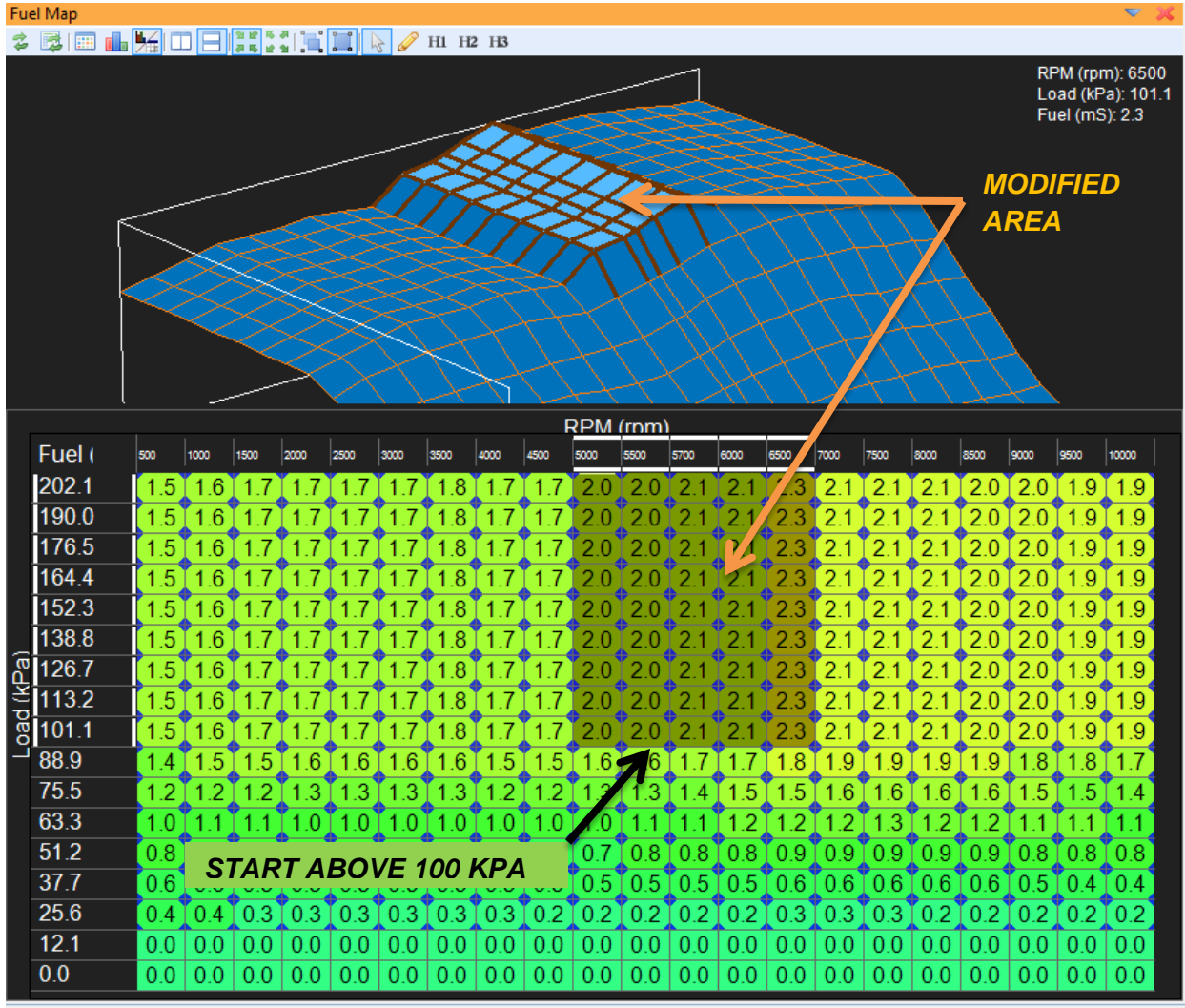

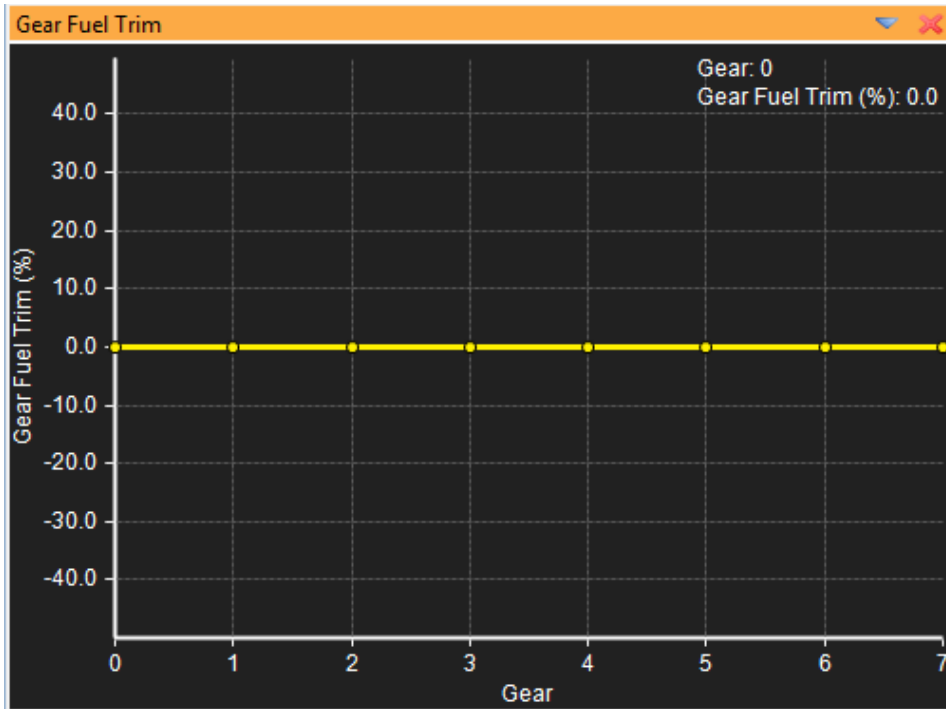

The **Gear Fuel Trim** table can be used to trim fuel vs gear position. **Note that the EMS must be configured to sense gear position for this table to function properly.**

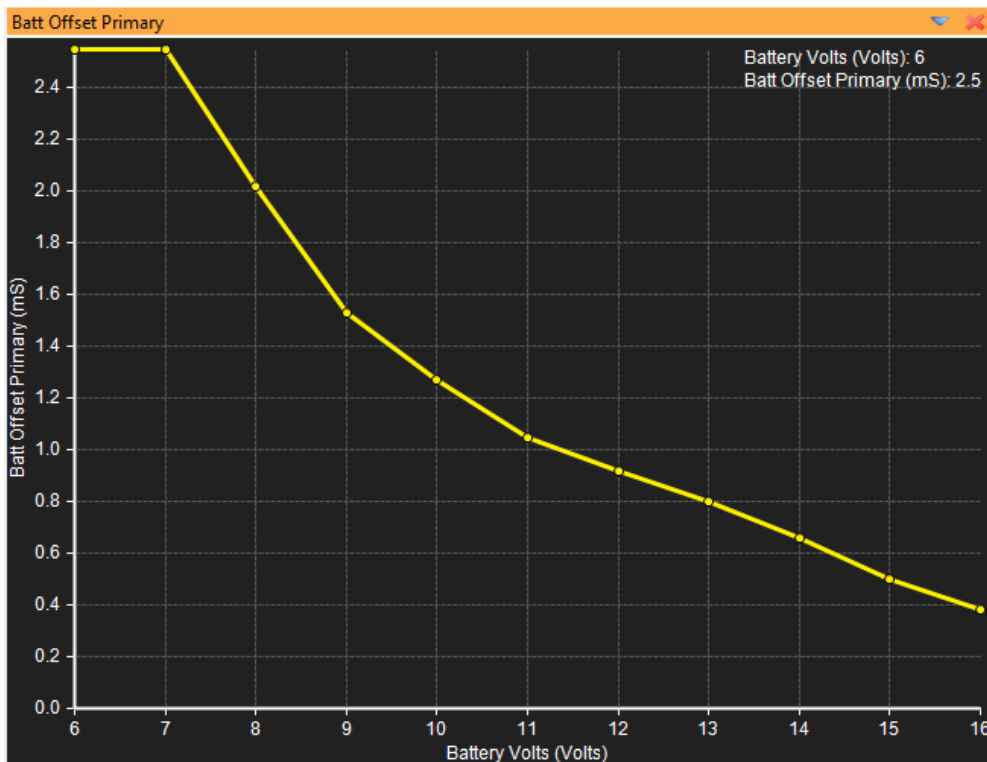

There are two battery offset tables for fuel injectors. One is used for the primary injectors or base injectors if the system is not configured for staged injection. The other is used for the

secondary or staged injectors. These tables compensate for the variable opening time that results from changes in battery voltage. These tables must be developed with proper equipment and AEM has many injectors pre-configured for you in the setup wizard as shown below:

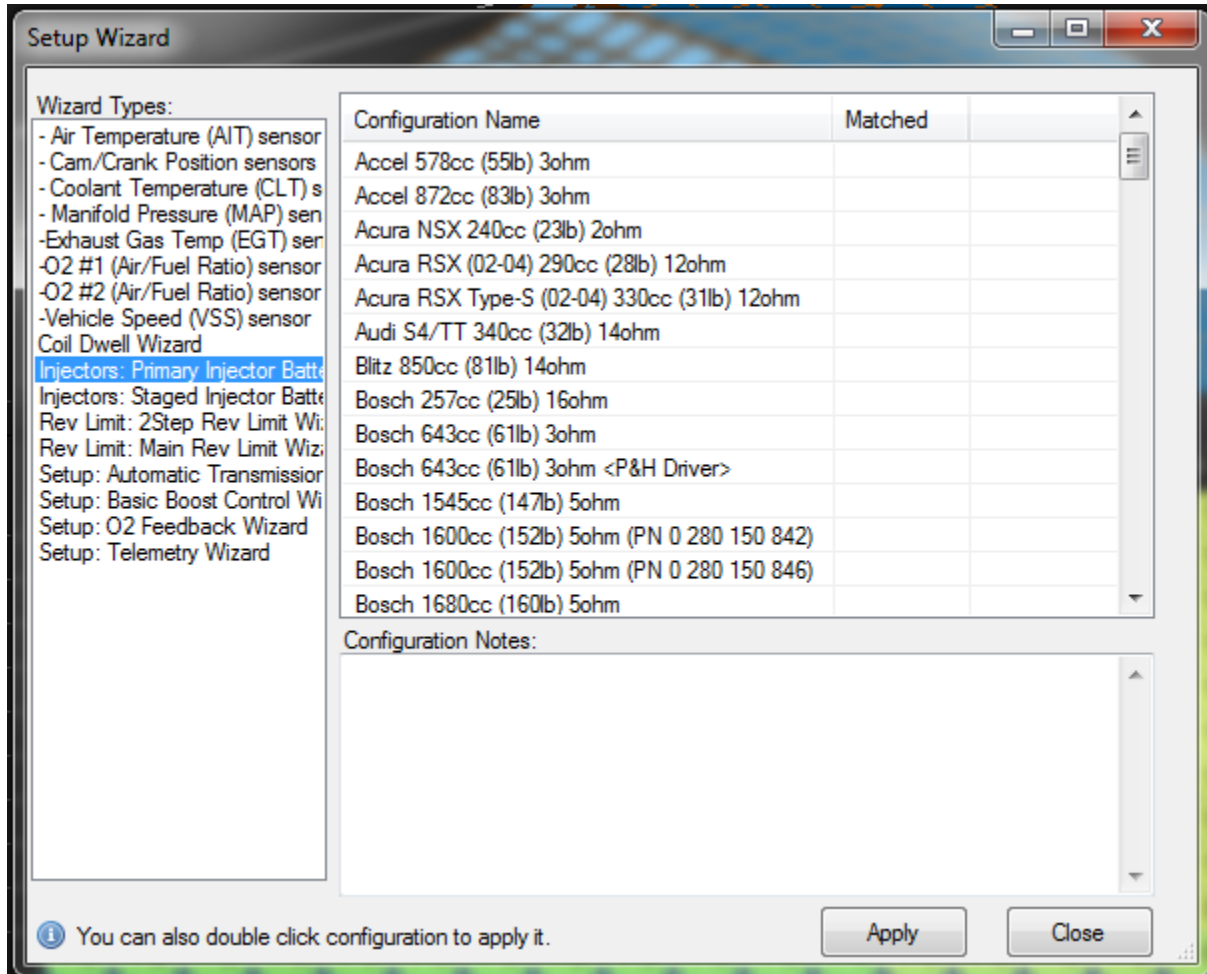

If you can't find your particular injector in the list, contact AEM to have a flow test performed using your injectors.

WARNING! EMS-4 SYSTEMS WILL NOT DRIVE LOW IMPEDANCE INJECTORS DIRECTLY. A RESISTOR BOX OR PEAK AND HOLD DRIVER MUST BE USED. CONNECTING AN EMS-4 DIRECTLY TO LOW IMPEDANCE INJECTORS MAY CAUSE DAMAGE TO THE EMS.

THE FOLLOWING SCHEMATIC ILLUSTRATES AN INSTALLATION USING THE AEM 30-2700 PEAK & HOLD DRIVER MODULE.

INJECTOR DRIVER REQUIRES
A LOW, OR GROUNDED INPUT
TO FIRE THE INJECTORS

**FROM
EMS-4**

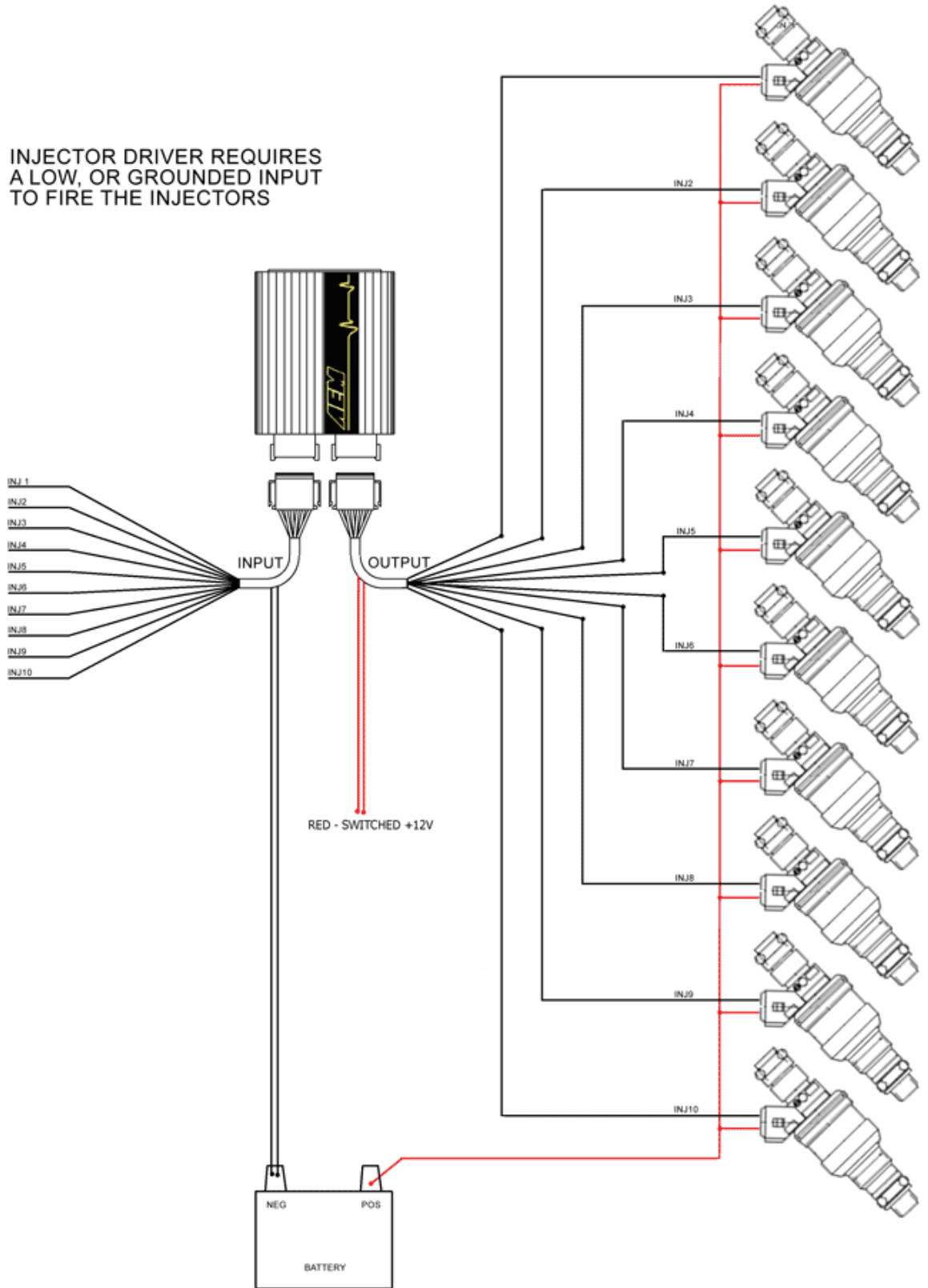

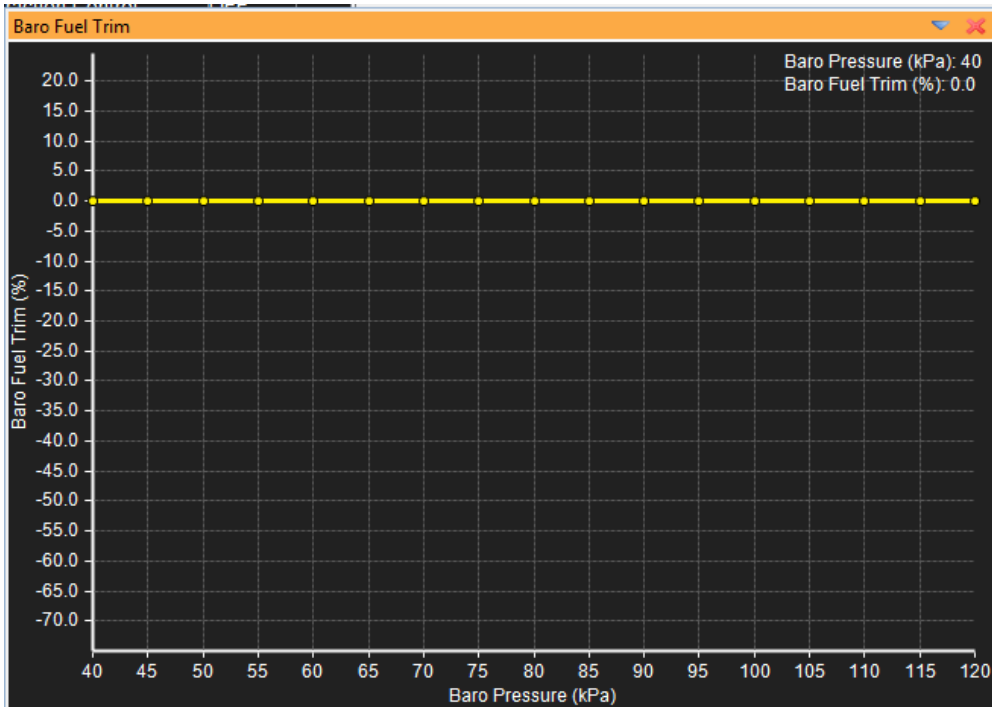

The **Baro Fuel Trim** table requires a barometric pressure sensor. Some plug & play EMS systems come equipped with a baro sensor. Check pinout sheet or schematic for more information. Alternatively, the baro sensor input can be defined as any available analog input using the selection dropdown as shown below:

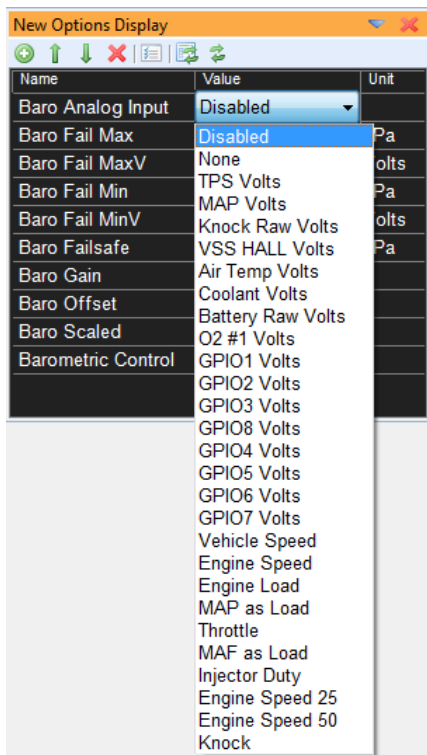

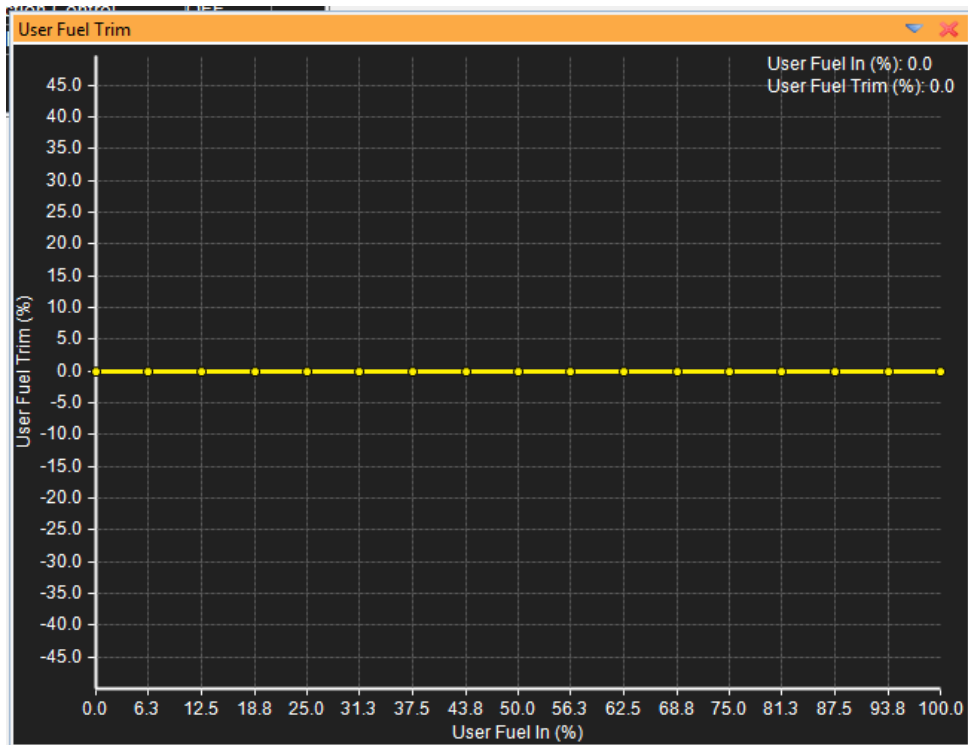

Options - Fuel Trims

Name	Value	Unit
User Fuel Analog In	None	
	Disabled	
	None	
	TPS Volts	
	MAP Volts	
	Knock Raw Volts	
	VSS HALL Volts	
	Air Temp Volts	
	Coolant Volts	
	Battery Raw Volts	
	O2 #1 Volts	
	GPIO1 Volts	
	GPIO2 Volts	
	GPIO3 Volts	
	GPIO8 Volts	
	GPIO4 Volts	
	GPIO5 Volts	
	GPIO6 Volts	
	GPIO7 Volts	
	Vehicle Speed	
	Engine Speed	
	Engine Load	
	MAP as Load	
	Throttle	
	MAF as Load	
	Injector Duty	
	Engine Speed 25	
	Engine Speed 50	
	Knock	

The **User Fuel Trim** table and function can be used to define any available analog input as a fuel trim. The **User Fuel Analog In** option is used to define the input. The table above defines a -50% to +50% trim based on that input. The X-axis in the table is 0 to 100% of the analog voltage input. This table is sometimes used with a 0 – 5V trim pot. The driver can manually adjust this trim any time.

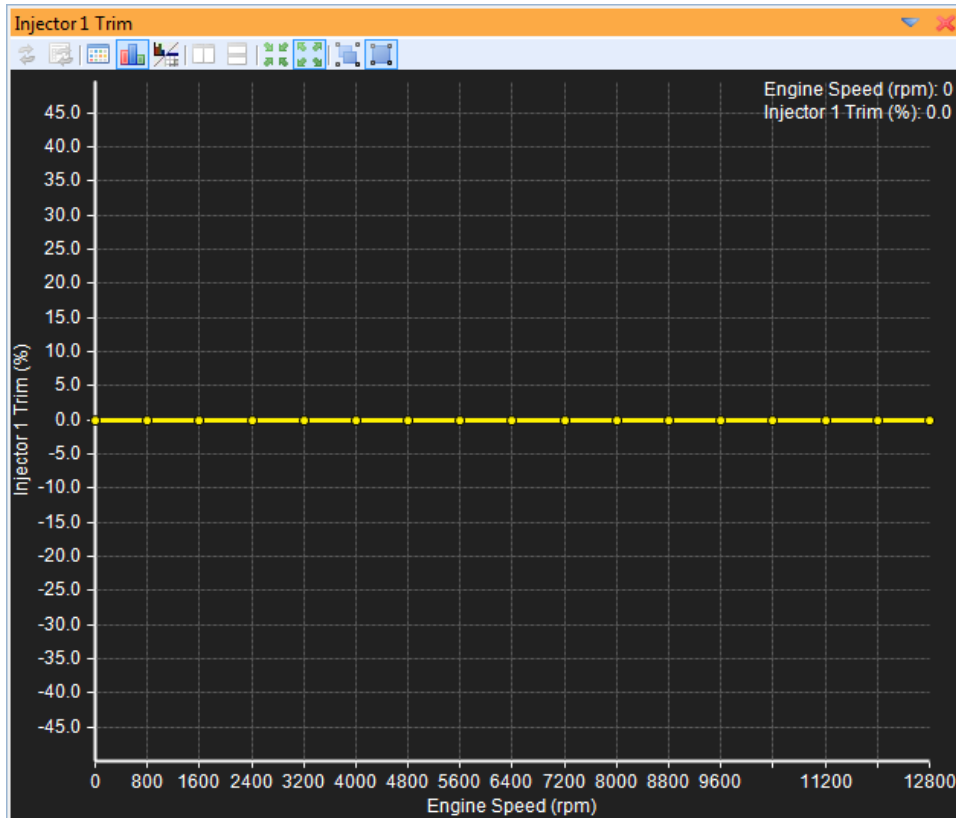

Individual cylinder trims are used to compensate for uneven air distribution. Each injector output has an associated trim table. The **Injector 1 Trim** table is used for the EMS injector #1 output. The X-axis of the table is engine RPM. Proper instrumentation is usually necessary to take full advantage of these tables. Either individual cylinder EGT data or individual cylinder AFR data is required.

If EGT data is used, note that it is sometimes difficult to know what side of “peak EGT” the engine is running on. Additional instrumentation is sometimes necessary to confirm the EGT data. See below for more information:

TYPICAL MIXTURE DISTRIBUTION EFFECT ON ENGINE PERFORMANCE

Locked Throttle
Fixed MBT Timing

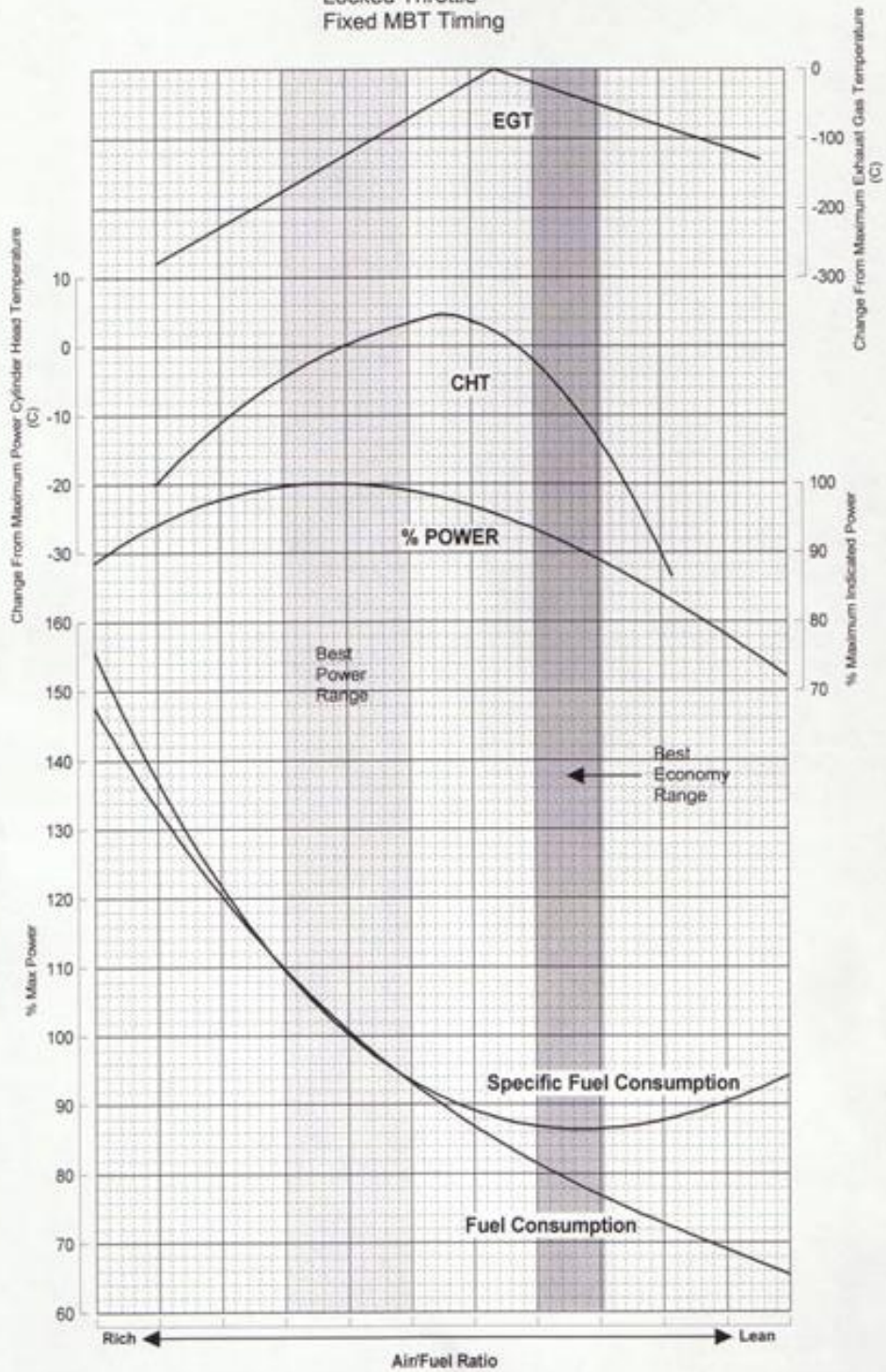

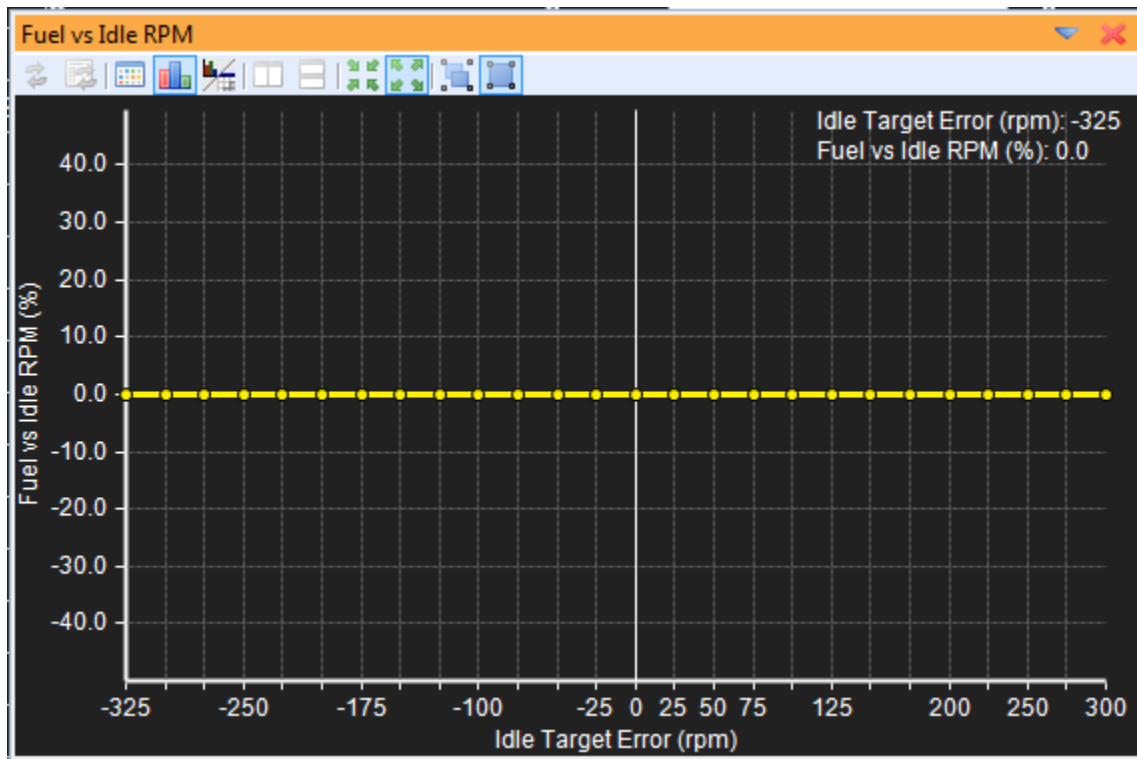

The **Fuel vs Idle RPM** table is used to trim the fuel injection pulse vs Idle Target Error. This table is not used very often.

Fuel Trim Channels

Name	Value	Unit
Fuel Map	5.44	mS
Throttle Mod	10.2	%
Fuel Trim AIT	0.0	%
Fuel Trim Baro	10.2	%
Fuel Trim Boost	10.0	%
Fuel Trim Coolant	9.8	%
Fuel Trim Gear	-10.2	%
Fuel Trim Idle	0.0	%
User Fuel Trim	0.0	%
Fuel Pulse	7.2	mS
Fuel Trim Bat-Pri	0.95	mS
Fuel Trim 1	10.16	%
Fuel Inj 1 Pulse	8.85	mS

Fuel Map – The raw commanded pulsewidth value directly from the **main fuel map**

Throttle Mod – The trim % taken from the **Throttle Fuel Trim** table

Fuel Trim AIT – The trim % taken from the **Air Temp Fuel Trim** table

Fuel Trim Baro – The trim % taken from the **Baro Fuel Trim** table

Fuel Trim Boost – The trim % taken from the **Boost Fuel Trim** table

Fuel Trim Coolant – The trim % taken from the **Warm Up Enrichment** table

Fuel Trim Gear – The trim % taken from the **Gear Fuel Trim** table

Fuel Trim Idle – The trim % taken from the **Fuel vs Idle RPM** table

User Fuel Trim – The trim % taken from the **User Fuel Trim** table

Fuel Pulse – The calculated fuel injection pulsewidth including all above trims

Fuel Trim Bat-Pri – The calculated fuel injection pulsewidth after the **Battery Off Primary** table trim is applied

Fuel Trim 1 – The trim % taken from the **Injector 1 Trim** table (individual cylinder trims). Other cylinders work the same way.

Fuel Inj 1 Pulse – The actual commanded pulsewidth for the injector #1 output after all trims have been applied.

Additional Function Based Fuel Trims

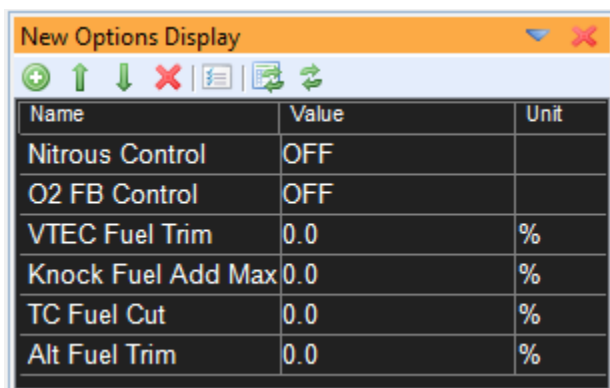

Name	Value	Unit
Nitrous Control	OFF	
O2 FB Control	OFF	
VTEC Fuel Trim	0.0	%
Knock Fuel Add Max	0.0	%
TC Fuel Cut	0.0	%
Alt Fuel Trim	0.0	%

Nitrous Control – Option to turn the Nitrous control function on/off. Fuel trim will be applied according to the values in the **N2O Fuel** map. See section on the Nitrous Control function for more information.

O2 FB Control – Option to turn the O2 Feedback Control function on/off. O2 feedback fuel trim will be applied according to the settings in the O2 Feedback Function setup.

VTEC Fuel Trim – Option that defines the fuel trim % when the VTEC function is active.

Knock Fuel Add Max – Option that defines the max knock fuel trim when knock function is active.

TC Fuel Cut – Option that defines the % fuel cut applied when the Traction Control function is active.

Alt Fuel Trim – Option that defines the % fuel trim applied when the Alt Function is active.

Acceleration/Deceleration Modifiers for Engine Fueling

When the throttle is rapidly opened or closed the demand for fuel increases or decreases. If at a low-throttle-angle, steady-state running condition the throttle is opened rapidly, manifold pressure increases. In this situation, the sudden demand for air (hence power) requires a temporary enrichment of the mixture to maintain a reasonable AFR. Because the rapid opening

of the throttle is consistent with the need for high-power AFR during acceleration, it is equivalent to the value needed for full power.

The amount of enrichment required is largely dependent on the design of the inlet tract and placement of the injectors. Enrichment for systems where the injectors are placed far from the inlet valves will have to be higher than if the injectors are placed near the inlet valves. This is because when the injectors are far from the inlet valves, such as on throttle body systems, there is considerable manifold wall wetting.

At low manifold pressures (commonly high manifold vacuum), fuel tends to stay in the air stream in a vapor-like state and has relatively low wetting characteristics. The reason the wetting is lower at high vacuum is because the pressure in the inlet manifold is closer to the vapor pressure of the fuel, allowing the fuel to evaporate more readily (This is the same phenomenon that makes water boil at a lower temperature at higher altitudes than at sea level).

As the throttle opens, manifold pressure increases (vacuum decreases), which increases the pressure on the fuel vapor driving it to a more liquid state. This causes droplets of fuel to deposit on the manifold walls and come out of the air stream. When the air speed in the inlet manifold increases to a point where the liquid fuel on the manifold walls is reintroduced into the air stream, there is no need for additional fueling and acceleration fuel is shut off.

With most modern road cars the injectors are placed near the inlet valves so that manifold wall wetting is virtually eliminated. With the elimination of wetting comes the drastic reduction of acceleration fuel requirement. This configuration of fuel injector needs short duration and a small amount of fuel for acceleration enrichment.

The prime input for acceleration data for the ECU is the throttle position sensor (TPS). The TPS indicates the rate of change of the throttle plate to the ECU so that it can calculate the amount of fuel in both volume (additional pulse width) and time (duration of additional pulse width). Very rapid throttle movements usually require a short duration of a large amount of fuel, while slow throttle changes use minimal amounts of additional fuel over a longer period.

When the throttle is closed rapidly the need for fuel is reduced sharply. Under deceleration manifold pressure is very low (high vacuum). Any fuel that was on the manifold walls, port walls, or valve head is re-introduced into the air stream due to the rapid decrease in manifold pressure resulting in a temporarily rich mixture. The main fuel MAP values are usually very low when experiencing low manifold pressure, so minimal fuel is being injected into the engine. However, the mixture will still be rich due to the re vaporization of the wetted fuel.

The AEM EMS can be programmed to turn off or nearly turn off the fuel injectors during periods of deceleration. This eliminates after burning in the exhaust manifold, and reduces hydrocarbon emissions. There is a range of RPM and manifold pressure that must be defined by the programmer to turn off the fuel. The RPM defined usually has a lower limit of idle speed plus 300 RPM. The manifold pressure is usually idle pressure minus 15 kpa. There is the possibility that a load value of idle – 15 kpa can be achieved during sustained running, but the throttle angle decrease must be sensed by the ECU to activate deceleration fuel cut.

Acceleration Fuel Function Options

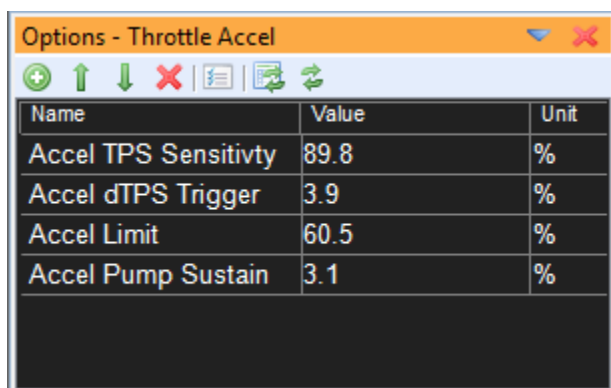

Name	Value	Unit
Accel TPS Sensitivity	89.8	%
Accel dTPS Trigger	3.9	%
Accel Limit	60.5	%
Accel Pump Sustain	3.1	%

Accel TPS Sensitivity – The larger this number, the larger the calculated **Accel dTPS** value will be for a given change in throttle position. Determines how sensitive the accel fuel function is to changes in throttle position.

Accel dTPS Trigger – The calculated **Accel dTPS** value must be higher than this number for the accel function to activate. Used as a filter to eliminate false triggering from normal signal noise.

Accel Limit – Used as a clamp for the accel fuel function. If the calculated accel fuel modifier is greater than this value, the modifier is clamped at this setting.

Accel Pump Sustain – Controls the rate at which accel fuel goes away. Actual formula used is current accel fuel % times this number calculated each engine revolution. A larger number makes the accel fuel trim stay active longer.

Tuning Throttle Accel

The operating principle is pretty standard. When the throttle is moved, the Accel dTPS value is calculated. It gives a number proportional to the rate of change of the throttle. If this value is above the user-specified threshold **Accel dTPS Trigger** option, then the acceleration pump is enabled. But, since the TPS signal is usually noisy, the accel pump would be triggering all the time. So we need to filter it before the threshold test is performed. The filter specification can be set with the **Accel TPS Sensitivity** option.

Once an Accel dTPS value is generated, the corresponding accel pump size is looked up from the **Accel vs dTPS** table.

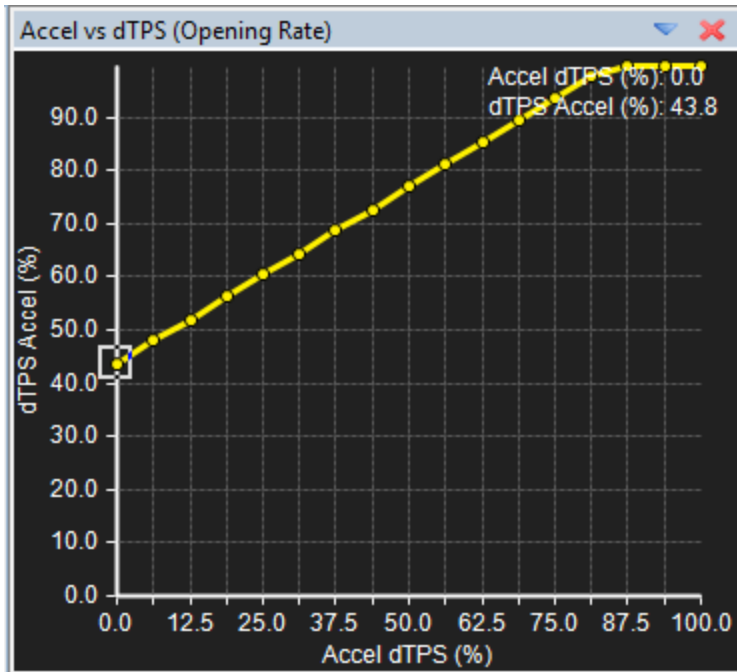

This table gives a % accel pump size, versus the dTPS value. This % size is relative to the current injector pulsewidth (PW). So if the current PW is 1,400 uS (1.4mS) and the % value was 75%, the base accel pump size would be 75% * 1.4mS = 1.05mS.

Once a base accel pump size is generated, it is immediately multiplied by the **Accel vs Throttle** table. This is a TPS based table and serves to scale the output based on the throttle position when the accel pump was activated. This table usually starts at 100% and decreases to 0% at high throttle value. This yields an accel pump value that varies by throttle angle and is usually large for throttle movements near closed throttle and small for throttle movements near WOT.

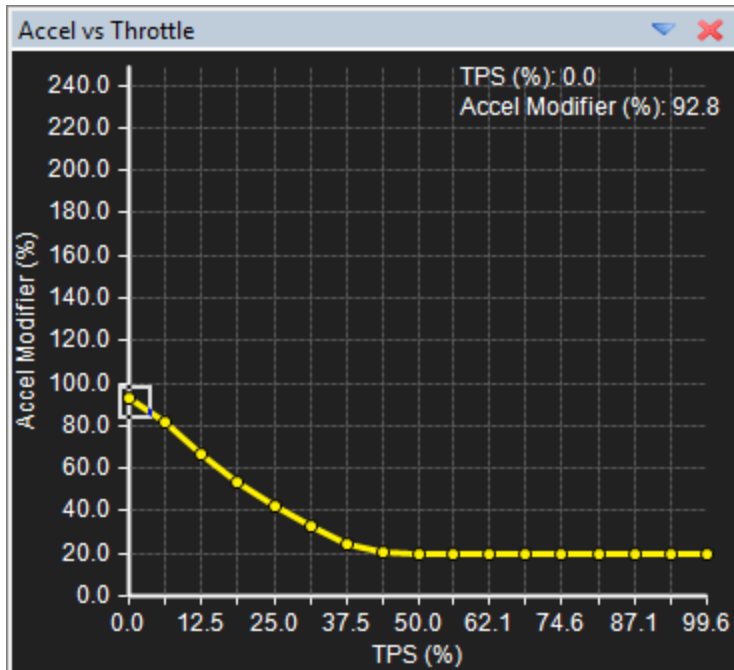

Next, it is multiplied by the **Accel vs Engine RPM** table, which is the RPM based correction for the dTPS component. This table usually starts at 100% and then decreases to a smaller value (sometimes 0%) at RPM values. This makes sense because the fuel delay is smaller at high port velocities; hence the accel pump can be smaller.

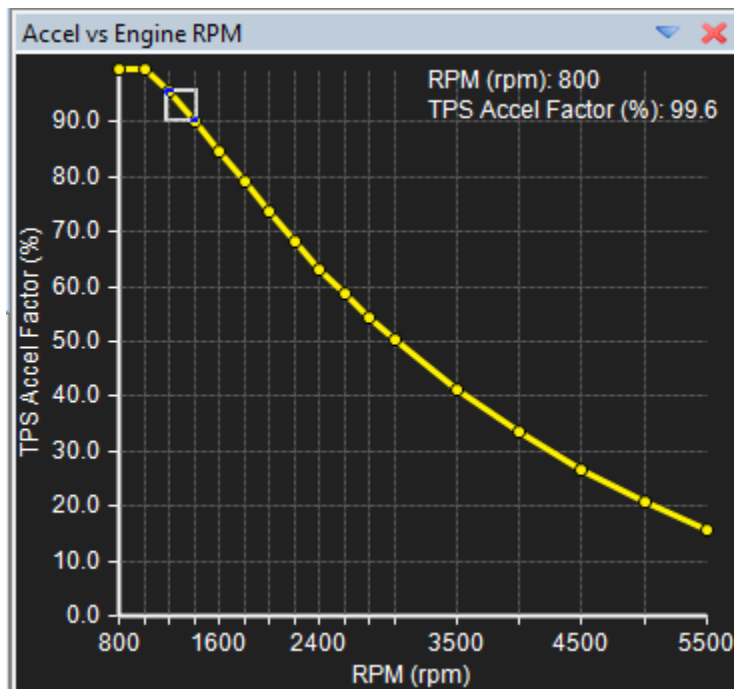

Next it is multiplied by the **Accel vs Coolant Temp** table. This incorporates a coolant

based trim to accel fuel because a cold engine will need more accel fuel compensation than a warm engine.

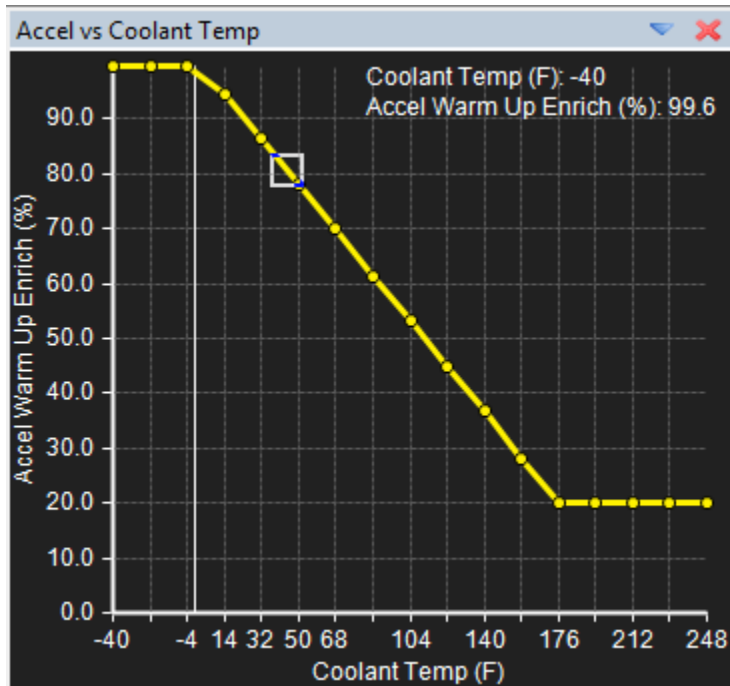

To recap what's happened, a filtered throttle position change has been detected and from this value, a base % accel pump was determined. Then it was corrected for TPS, RPM and Coolant temperature.

Now, it is checked against the user option **Accel Limit**. If it is larger than this value, then it is reset to this value. This percentage is multiplied by the current injector PW, giving a time in uS, and is applied as the starting value for the accelerator pump.

Once the pump is applied, the EMS decreases the pump size to zero, assuming there are no more accel pump actions in the meantime. This is controlled with the **Accel Pump Sustain** option. On a fixed time basis, the EMS comes back, and multiplies the current value of the pump by the decay percentage, yielding the new, decayed pump. Thus, a larger value makes the pump decay slower.

Accel Fuel Channels

Accel dTPS	0.0	%
Accel dTPS Latched	46.9	%
Accel Trigger Count	212	
Accel Fuel +Max	16.2	mS
Accel Fuel	0.0	mS

Accel dTPS – Displays the current delta TPS value

Accel dTPS Latched – Displays the last activated delta TPS value

Accel Trigger Count – Displays the current number of times the accel pump has been triggered. Resets at 255.

Accel Fuel +Max – Displays the current allowable size for the accel pump based on the current injector PW and Accel Limit value

Accel Fuel – Current calculated Accel Fuel value in milliseconds

Ignition Tuning Theory

Some basic terms, concepts and recommendations should be understood prior to beginning the ignition tune.

Spark Plugs

Spark plug selection affects engine performance. On forced induction engines, it is critical that the proper heat range and gap is used. Heat range refers to the ability of the spark plug to conduct heat away from the electrode to the engine. A plug that has high thermal conductivity has a short insulator that comes in contact with a large portion of the metallic plug shell. This large area allows the combustion heat to be carried through the plug shell to the cooling jacket of the cylinder head. In the case of a hot plug, the insulator is recessed deeply into the plug shell with minimal contact to the shell. The plug has low thermal conductivity due to the lack of contact with the shell. The nose of the insulator should operate at between 400 – 850 degrees C. Temperatures above 400 degrees C are desirable because at higher temperatures deposits from carbon, lead or soot are burnt off. Temperatures of 850 degrees C and over should not be exceeded because this is typically the point where detonation or auto ignition can occur. Lower heat range plugs have a higher resistance to auto ignition while higher heat range plugs have less tendency to foul.

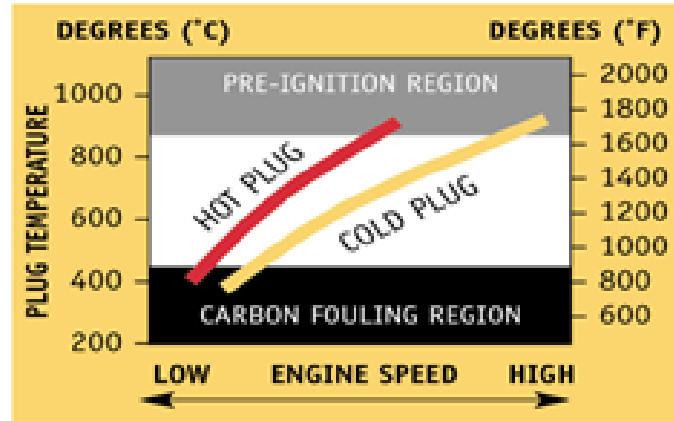

TEMPERATURE CURVES OF HOT AND COLD PLUGS

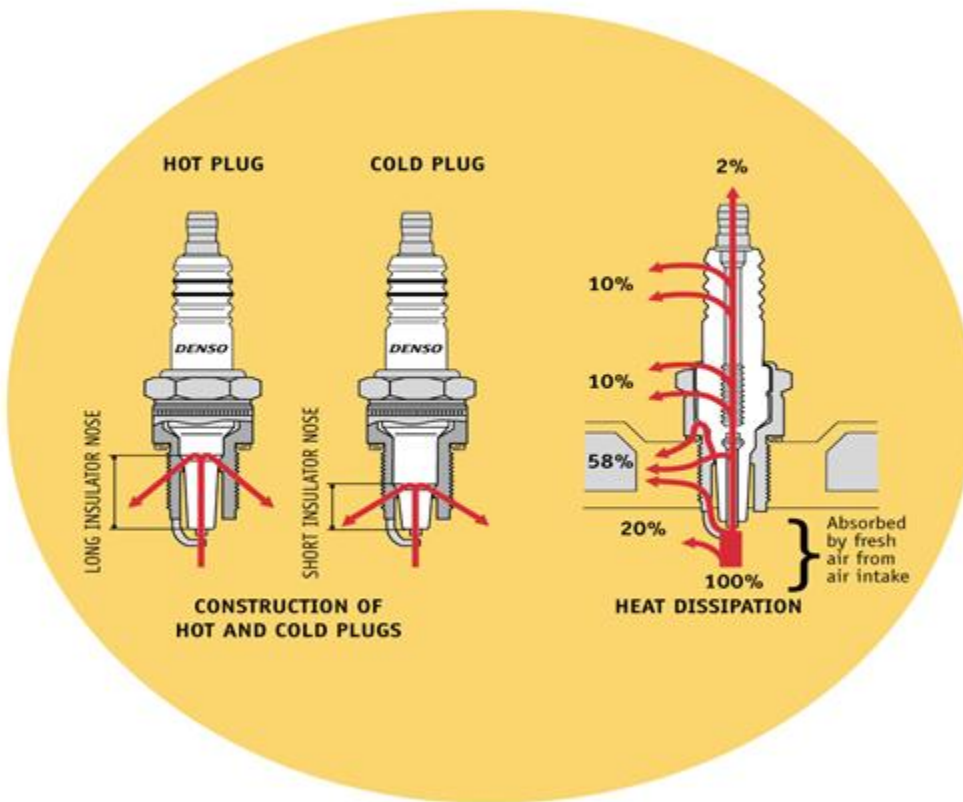

The spark plug gap on forced induction engines should be reduced REGARDLESS of the type of ignition system. We have read many instruction manuals for aftermarket ignition systems that recommend that the plug gap be opened up for better flame propagation. Although this recommendation may have had some merit when vehicles had carburetors, it does not apply to modern engines with electronic engine management systems. The smaller gap on forced-induction engines requires less spark energy to arc across the ground and the electrode and

has a lesser tendency to misfire under the extreme pressures of a racing engine combustion chamber. Also there are spark plugs made with exotic fine wire highly conductive center electrodes that require less energy to fire such as the Denso Iridium that are well suited to racing conditions. The following is a chart of gap sizes for various engines on gasoline:

Naturally Aspirated up to 11.0:1 CR	1.1mm (.044")
Naturally Aspirated 11.0:1 to 14.0:	1.8mm (.032")
Forced Induction to 20-PSI	.7mm (.028")
Forced Induction to 40-PSI	.6mm (.022")

The color or condition of the spark plug is a general indicator of how rich or lean the engine is running and also if the engine is exhibiting signs of detonation if it is not audible. This is a plug color chart (supplied courtesy of Denso) of plug conditions.



Engine Knock (Detonation) and Preignition

It is important to understand the mechanisms that cause knocking and preignition to set up an ignition map that is suitable for the engine. Auto ignition, also known as knocking, pinging, or detonation, is generally caused by improper combustion in an engine. An internal combustion engine runs properly when the spark-initiated combustion wave expands rapidly but smoothly throughout the combustion chamber. Combustion knock is caused by spontaneous ignition in

the hot unburned portion of the fuel mixture (typically referred to as end gas) in the combustion chamber. The remaining charge portion is compressed first by the upward piston movement and then by the moving flame front. Knocking is the almost instantaneous ignition of part of the remaining mixture. This mixture auto ignites because the rapidly rising pressure and temperature caused by the piston movement and the expanding gas from the flame front are sufficient to ignite the remaining gasses. To illustrate the loads imposed on the engine components by knocking, note that normal combustion speeds are about 12-25 m.s⁻¹ while knocking combustion speeds may be as high as 250-300 m.s⁻¹. The next illustration depicts the

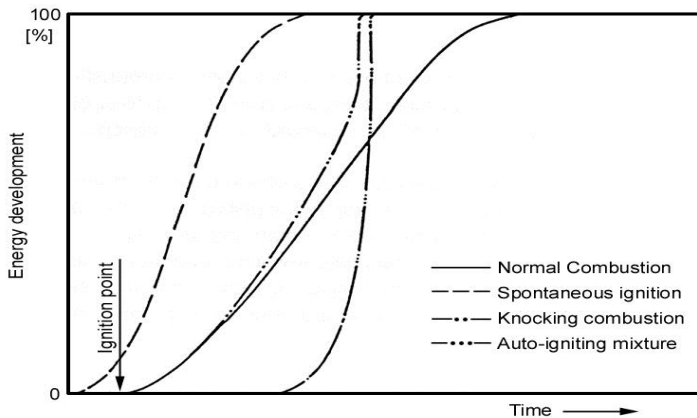

difference between a normal and abnormal combustion process. If the gasoline-air mixture auto-ignites somewhere in the cylinder (other than at the spark plug) just after spark ignition, the auto-ignition combustion wave can collide with the spark-initiated combustion wave, causing the vibration we hear as a knock or ping. Depending on its intensity, knocking combustion may range from barely audible “pinging” to a rather violent thumping. The point at which the knocking becomes damaging to the engine is dependent on the components used in the engine. If sustained knocking occurs, then the pistons may be damaged. When knocking reaches a violent thump, engine operation should be ceased or at minimum the load and temperature reduced to prevent engine damage. Light knocking that happens during acceleration is less harmful and may not damage the engine. Knocking tendency is increased by the following design or operational characteristics:

- High Engine loads encountered while towing a vehicle.
- Using low octane gasoline in a high-compression engine.
- Too much timing advance for the type of fuel being used.
- Higher air density, (this can be caused by starting a calibration at high altitude and then traveling to a lower one, or the addition of forced induction).
- Increased temperatures and pressure in the combustion chamber due to inadequate engine cooling.
- Excessive inlet air temperature.
- Spark plugs with an improperly high heat range.
- A non-central spark plug location in the combustion chamber.
- An elongated combustion chamber design.

- Too lean of an air/fuel mixture.

The following tuning adjustments can be performed on an engine to reduce or eliminate knocking:

- Reduce ignition timing.
- Verify that the air/fuel mixture is adequate for your engine set up.
- Verify that the spark plugs are of proper heat range.

Preignition is the ignition of the charge in the combustion chamber before the spark occurs. This type of ignition is caused by a very hot, or even incandescent surface in the combustion chamber. These “hot spots” can be an overheated spark plug, a glowing remnant of carbon in the chamber or even a hot exhaust valve edge. The preignition condition flame front rapidly expands while the piston is still on its way up the bore. Due to the very high pressure generated by the expanding flame front and the piston approaching TDC, the combustion chamber pressure rises rapidly causing audible knocking. Detonation and preignition typically have a cause and effect relationship; when detonation is prolonged and overheats the spark plug to the point where the tip glows, preignition occurs. Preventative measures can be taken to avoid preignition by using spark plugs with the correct heat range, avoiding detonation by using fuel with the correct octane rating for your application, and when building an engine, ensuring that there are no machined components with sharp corners in the combustion chamber. Also, the cooling system must be in good working condition to effectively cool the combustion chamber. Sustained operation of an engine in either of these conditions can result in severe engine damage.

At low manifold pressure the flame front is slower due to the low density of mixture in the combustion chamber. Because peak manifold pressure is optimal at 15-20 degrees ATDC and the burn rate is slower at very low manifold pressure, the ignition point must be started earlier. The main ignition map typically has high ignition timing values during times of low manifold pressure and high RPM, which gradually decreases at load increases.

As the throttle is opened, the density of the mixture increases and the flame propagation increases in speed. The timing must be reduced as load and RPM increase to keep the peak pressure at approximately the same point and reduce the chances of knocking.

With forced induction engines, the burn rate increases as charge density is increased. In this example, timing must be reduced because of the faster burn rate, and to further reduce the chances of knocking. On forced induction engines, the inlet charge temperature is elevated because of the heat generated by compressing the air. Utilizing an intercooler or after-cooling system usually helps reduce the inlet charge temperature. But in many cases this still will not bring the inlet charge down to ambient temperature, making the engine more susceptible to knocking.

Remove the spark plugs each time the timing is increased to a higher value and check for signs of detonation. The spark plug is the best indicator of what is happening in the engine because it is such an integral part of the combustion chamber. If you see small flecks of black deposits, or

very small shiny beads on the porcelain of the plug, there is a good chance that the engine is knocking. Retard the timing to eliminate the knocking, enrich the mixture, or use a higher octane of fuel.

The combustion chamber plays an important role in the amount of ignition timing that can be used for the various operational phases of an engine. The most common type of combustion chamber design used in contemporary engines is a four-valve/cylinder, pent roof chamber. There are many other types of combustion chambers, such as a wedge, hemispherical, and canted valve, to name a few. Ideally, it is best to initiate flame propagation at the geometric center of the chamber. However, this is typically impossible to do because the spark plug is usually located at the top or edge of the combustion chamber. The reason it is desirable to have the flame front start at the geometric center of the combustion chamber is because there is less chance of autoignition of the mixture.

A pent roof combustion chamber places the spark plug near the center of the combustion chamber. Wedge combustion chambers are the most sensitive to spark knock because of the distance the flame front must travel within the bore prior to the power stroke.

When ignition occurs, a flame kernel starts at the spark plug electrode and expands across the combustion chamber. As the front progresses across the chamber, the hot expanding gas compresses and heats the end gasses and mixture at the opposite end of the chamber. If the pressure, and consequently temperature, inside the chamber increases beyond the flash point of the end gas, autoignition occurs. Because the pent roof type of chamber has a spark plug that is nearer to the geometric center of the chamber, the flame travels more evenly across the combustion chamber, leaving very little end gas that can be compressed or ignited by the advancing flame front. Thanks to the short distance the flame front has to travel in pent roof type chambers, ignition timing usually does not have to be as advanced as much as a wedge type chamber, to achieve maximum torque. We find that there is usually about five to eight degrees less timing required for pent roof combustion chambers than for wedge types.

Charge motion, which is comprised of intake swirl and squish; increase combustion speed when compared to a standard combustion chamber. The combination of these factors increases the mean effective pressure (MEP), lowers fuel consumption, and delivers smaller cycle-to-cycle variations at full throttle operation.

In addition to the performance benefit of effective charge motion, the resulting factors reduce Hc emissions, with a slightly increased NOx component. At partial load the benefits of charge motion vs. a standard combustion chamber are similar, but due to the decrease in density of the intake charge, not very.

The combination of swirl and squish is greater than either squish or swirl alone. Swirl improves mixture preparation and is mostly responsible for reducing ignition delay and cycle-to-cycle variations. Swirl is accomplished through the inlet port design or by using shrouded valves in the combustion chamber. As engine speed increases, the swirl motion increases along with it. Cycle-to-cycle variations decrease with increasing swirl action.

Squish is accomplished via a small gap between the head deck and the piston top. The decrease of this gap drives the inlet charge toward the spark plug electrode. An additional benefit of having this small gap is the reduction of end gas volume at the extreme edges of the cylinder. This reduces the tendency for spark knock and leads to a reduction of Hc emissions.

Cycle-to-cycle variation refers to a situation where an engine operates on the threshold of knocking or detonation throughout the engine cycles and is based on the average peak pressure of all of the cycles. The cycles with lower peak pressures may not be prone to detonation, while those with higher peak pressures may detonate with increasing intensity as peak pressure increases. Increasing this cyclic variation will increase the number of cycles that detonate, and decreasing the number leads to less cycles that detonate.

Ignition Delay is the point at which perceptible inflammation of the mixture and a pressure rise in the combustion chamber occurs. The time between when spark occurs at the spark plug and when inflammation of the mixture occurs is the delay time. This delay is caused by the chemical reactions that take place when the rate of reaction after the delay accelerates to an extent that noticeable combustion and a rise in cylinder pressure and temperature occurs. The chemical reaction within and on the surface of the initial flame kernel causes energy to be released during the ignition delay period. When the flame front is at this initial stage of propagation there are energy losses via conduction, radiation, and convection of heat. If too much of this energy is lost, the mixture will fail to propagate and a misfire will result.

As compression ratio increases the requirement for charge motion in the chamber is reduced. Engines that have high compression ratios generally require reduced ignition timing requirements due to the increased flame speed. The design of the combustion chamber in a high compression engine is necessarily small. The compactness of the chamber imparts its own charge motion and squish into the mixture.

We have included some sample ignition timing maps for gasoline engines that are typical for use on a street car. These examples include a naturally aspirated engine, forced-induction engine, and a high-compression engine. **These are conservative samples that should be used as a starting point only.**

The tuner of the engine must use good judgment when selecting the appropriate timing map for the engine.

*Naturally Aspirated Piston Engines W/ Pent roof
Combustion Chamber*

Ignition Timing

L	100	15	22	32	33	33	33	33	33
O	90	15	22	33	34	34	34	34	34
A	80	15	22	33	35	35	35	35	35
D	70	15	23	35	35	35	35	36	36
	60	15	24	35	35	36	36	37	37
I	50	15	24	35	35	36	36	37	37
N	40	15	24	37	37	38	39	40	40
	30	15	24	37	37	38	39	40	40
K	20	15	25	40	45	45	45	45	45
P	10	15	25	40	45	45	45	45	45
A		1000	2000	3000	4000	5000	6000	7000	8000

RPM

Turbocharged Piston Engines W/ Pent roof Combustion Chamber

Ignition Timing

L	300	11	14	23	23	24	24	24	24
O	275	11	15	24	24	25	25	25	25
A	250	11	15	24	24	26	26	26	26
D	225	11	16	24	26	27	27	27	27
	200	12	17	26	27	27	27	27	27
	175	12	19	28	29	29	29	29	29
I	150	12	20	29	30	30	30	30	30
N	125	12	20	30	30	31	31	31	31
	100	15	22	32	33	33	33	33	33
K	75	15	23	35	35	35	35	36	36
P	50	15	24	35	35	36	36	37	37
A	25	15	25	40	45	45	45	45	45
		1000	2000	3000	4000	5000	6000	7000	8000
		RPM							

Naturally Aspirated Piston Engines W/Wedge Combustion Chamber

Ignition Timing

L	100	15	22	32	35	35	35	35	35
O	90	15	22	33	35	35	35	35	35
A	80	15	22	34	35	35	35	35	35
D	70	15	23	34	35	36	36	37	37
	60	15	24	35	35	36	36	37	37
I	50	15	24	35	35	36	36	37	37
N	40	15	24	37	37	38	39	40	40
	30	15	24	37	39	39	39	40	40
K	20	15	25	40	47	47	47	47	47
P	10	15	25	40	47	47	47	47	47
A		1000	2000	3000	4000	5000	6000	7000	8000
		RPM							

Turbocharged Piston Engines W/Wedge Combustion Chamber

Ignition Timing

L	300	11	14	23	23	24	24	24	24
O	275	11	15	24	24	25	25	25	25
A	250	11	15	24	24	26	26	26	26
D	225	11	16	24	26	27	27	27	27
	200	12	17	26	27	27	27	27	27
	175	12	19	29	30	30	30	30	30
I	150	12	20	30	31	31	31	31	31
N	125	12	20	32	32	33	33	33	33
	100	15	22	34	35	35	35	35	35
K	75	15	23	34	35	36	36	37	37
P	50	15	25	40	47	47	47	47	47
A	25	15	25	40	47	47	47	47	47
		1000	2000	3000	4000	5000	6000	7000	8000
		RPM							

Ignition Map

The **Ignition Map** is the main ignition table in the calibration.

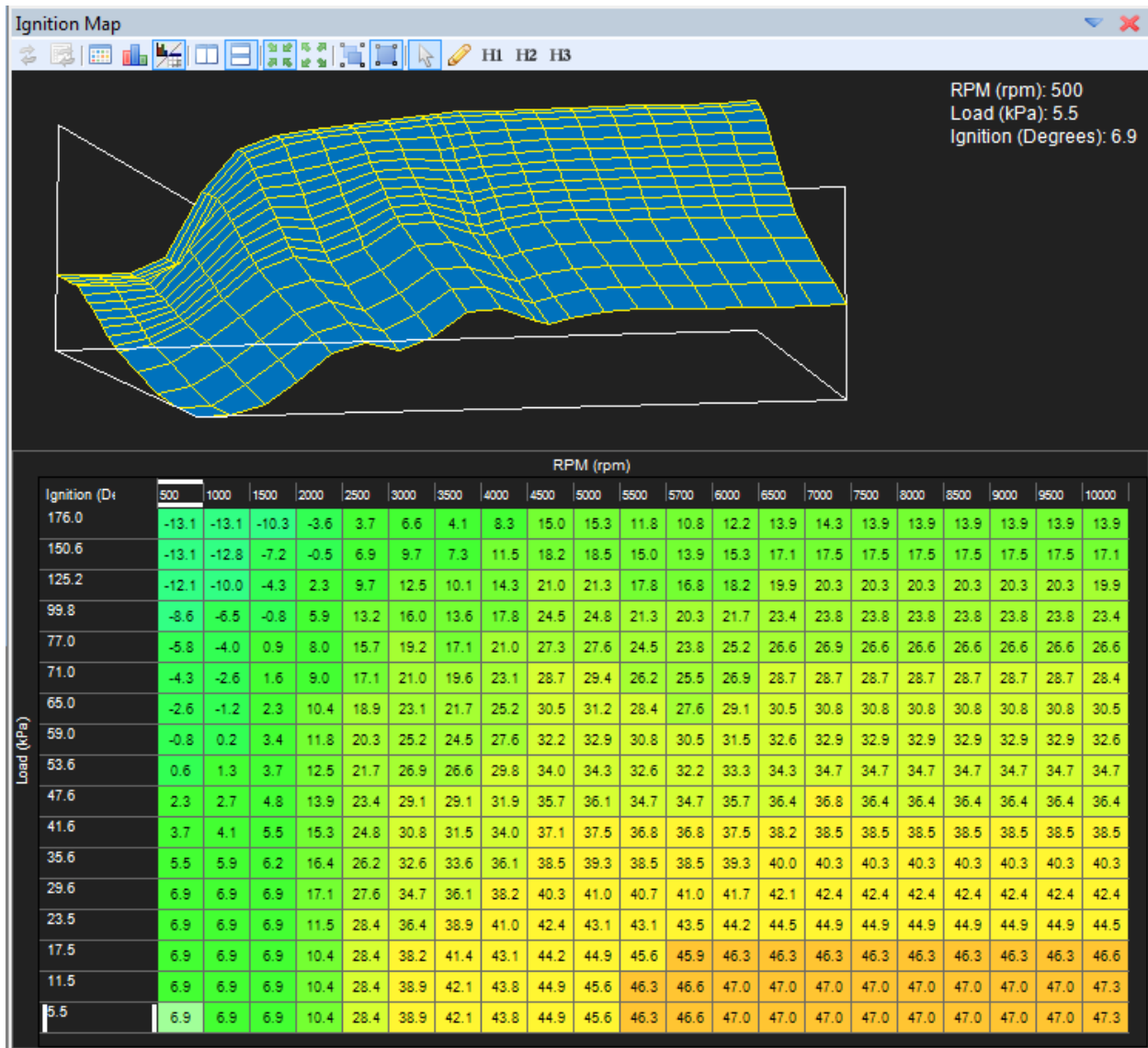

Ignition Trims

Similar to fuel there are several 2D tables that can be used for trimming ignition timing. The following section describes each.

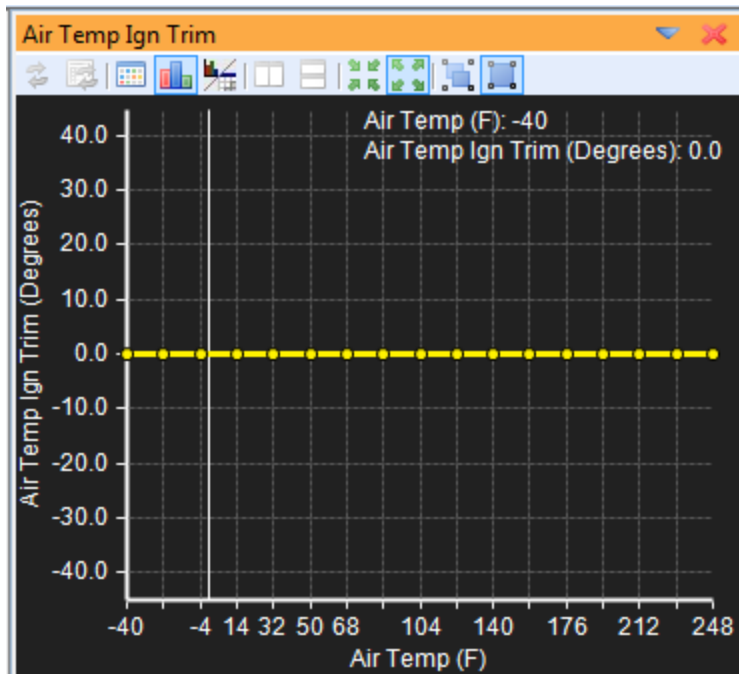

The **Air Temp Ign Trim** table is used to trim the ignition timing vs inlet air temperature. Often used on boosted applications as a safety mode. Ignition timing is reduced at very high air temperature readings to avoid detonation. Note that the trim values in this table are added (positive values) or subtracted (negative values) from the base ignition timing.

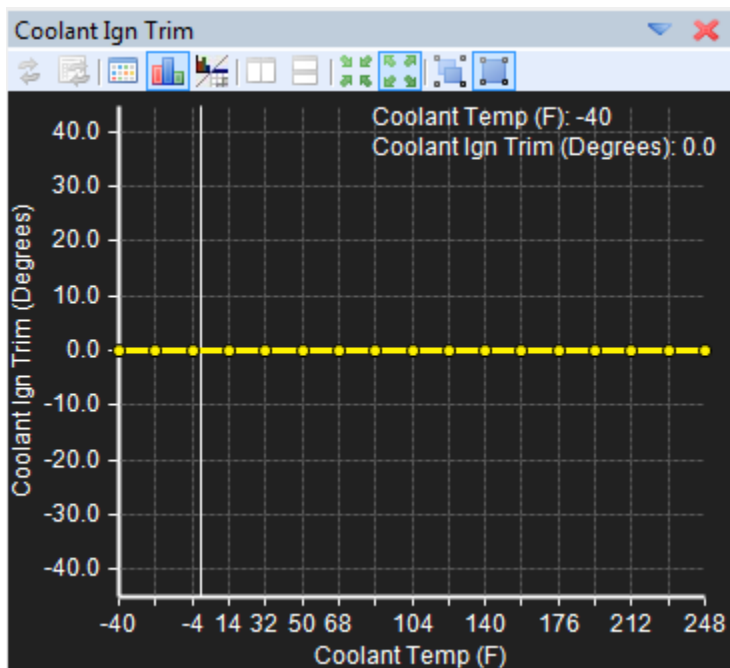

The **Coolant Ign Trim** table is used to trim the ignition timing vs coolant temperature. Sometimes used on N/A applications with very large camshafts to help with warmup. A few

degrees of additional timing during warmup can help quite a bit. Note that the trim values in this table are added (positive values) or subtracted (negative values) from the base ignition timing.

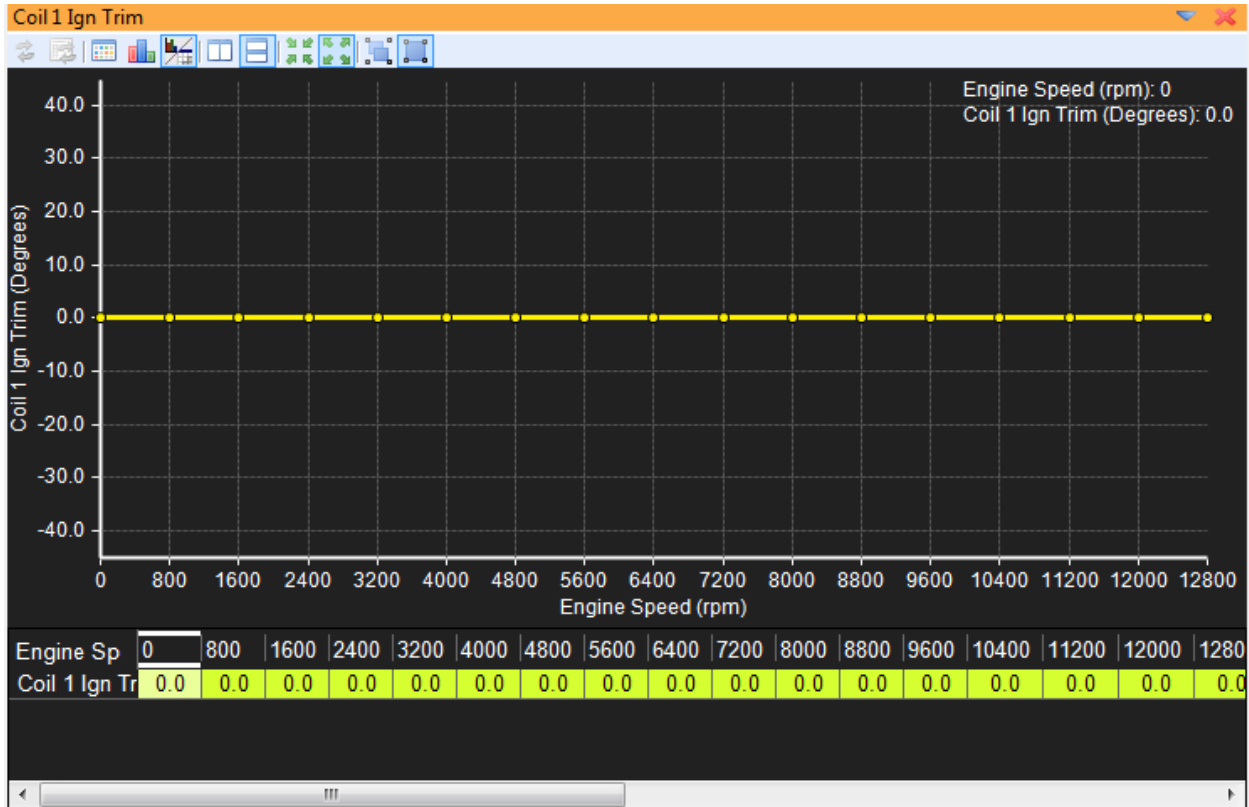

Individual cylinder trims are used to compensate for uneven air/ fuel distribution or cylinder cooling problems. Each EMS coil output has an associated trim table. The **Coil #1 Ign Trim** table is used for the EMS Coil #1 output. The X-axis of the table is engine RPM.

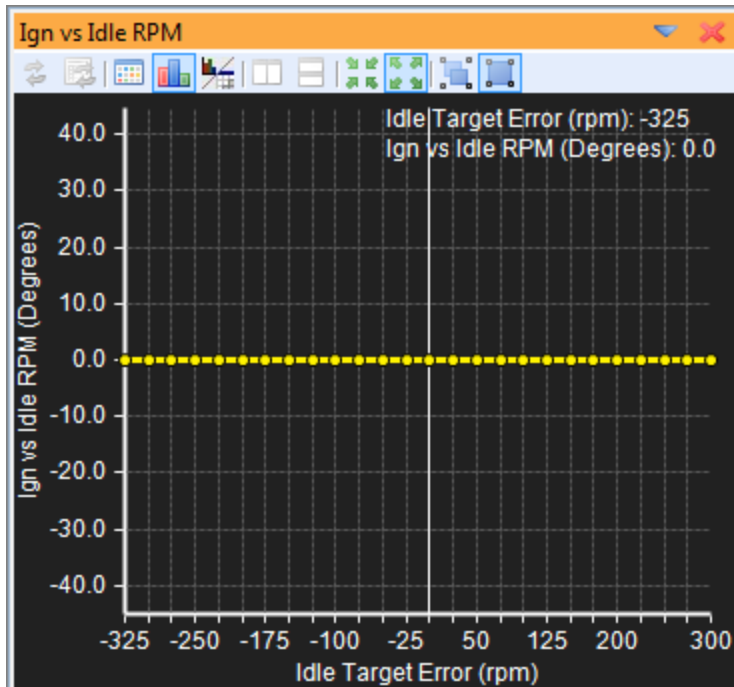

The **Ign vs Idle RPM** table is used to trim ignition timing vs Idle Target Error.

Ignition Trim Channels

Name	Value	Unit
Ign Map	8.66	Degrees
Ign Trim AIT	0.00	Degrees
Ign Trim Coolant	0.00	Degrees
Ign Trim Idle	0.00	Degrees
Ign Trim Gear	0.00	Degrees
Ign Trim 1	0.00	Degrees
Knock 1 Retard	0.0	Degrees
Ign Timing	8.7	Degrees

Ign Map - Displays the current ignition timing from the Ignition Map

Ign Trim AIT - Displays the current ignition timing correction for air temperature from the **Air Temp Ign Trim** table

Ign Trim Coolant - Displays the current ignition timing correction for coolant temperature from the **Coolant Ign Trim** table

Ign Trim Idle - Displays the current ignition timing correction for idle from the **Ign vs Idle RPM** table

Ign Trim Gear - Displays the current ignition timing correction for idle from the **Gear Ign Trim** table

Ign Trim 1 - Displays the current ignition trim (in degrees) from the **Coil 1 Ign Trim** table. All other coil output are similar in function.

Knock 1 Retard - Displays the current ignition retard from the knock #1 sensor in an attempt to eliminate detonation.

Ign Timing - Displays the current ignition timing of the engine after all compensators have been calculated

Vehicle Speed

Once setup, the vehicle speed input can be logged and used for many functions including speed dependent boost control.

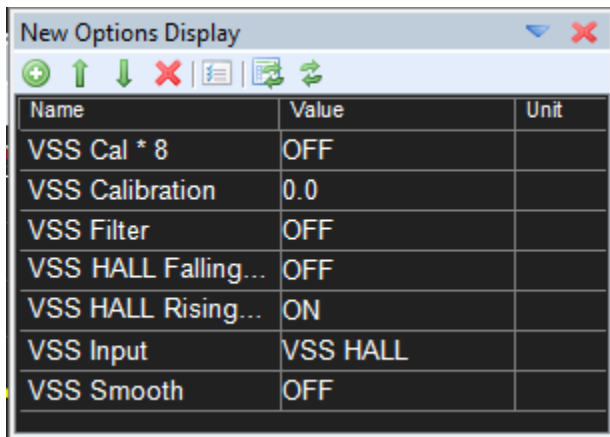

Name	Value	Unit
VSS Cal * 8	OFF	
VSS Calibration	0.0	
VSS Filter	OFF	
VSS HALL Falling...	OFF	
VSS HALL Rising...	ON	
VSS Input	VSS HALL	
VSS Smooth	OFF	

Vehicle Speed Setup Options

VSS Cal * 8 Units: On/Off Description, This is the coarse adjust for the vehicle speed input. Setting this ON increases the range of the **VSS Calibration** option.

VSS Calibration Units: Multiplier Description, This is the fine adjust for the vehicle speed input. Increasing this number makes the calculated vehicle speed increase. If 256 is not enough, set

the option **VSS Cal * 8** to ON. This will allow more range.

VSS Filter Units: On/Off Description, Used to smooth the speed sensor. Use as first defense.

VSS Hall Falling Units: On/Off Description, Sets falling edge as significant edge.

VSS Hall Rising Units: On/Off Description, Sets rising edge as significant edge.

VSS Smooth Units: On/Off Description: Used to smooth the speed sensor. This is very aggressive. This should be used after **VSS Filter** but only if needed.

VSS Input Units: User Definable Input Description: Channel of the input for the Vehicle Speed Sensor. For EMS-4 applications, set to VSS Hall input.

Vehicle Speed Channels

Vehicle Speed Units: Vehicle Speed Description: Displays the current scaled speed of the vehicle via the vehicle speed sensor.

Tuning the VSS

First, determine which channel the speed input is wired to. For plug n play applications, 99% of the time it will go to the Vehicle Speed input (also known as "Speedo" or "T3"). For EMS-4 applications, set to **VSS Hall**.

The edge must now be defined. Select rising or falling edge options described above.

Now, the sensor should be scaled so it reads the actual vehicle speed. Display the **Vehicle Speed** parameter and start adjusting **VSS Calibration** to scale the function. **If 256 is not enough, set VSS Cal * 8 to ON. This will allow more adjustability.**

Tuning Tip - A chassis dyno is especially helpful here as they usually have very accurate roll speed sensors. Use the dyno to hold the vehicle at a constant speed and adjust the VSS calibration options until the displayed vehicle speed value in AEM Tuner matches the value displayed by the chassis dyno.

EMS-4 GPIOs

GPIO as PWM driver output example

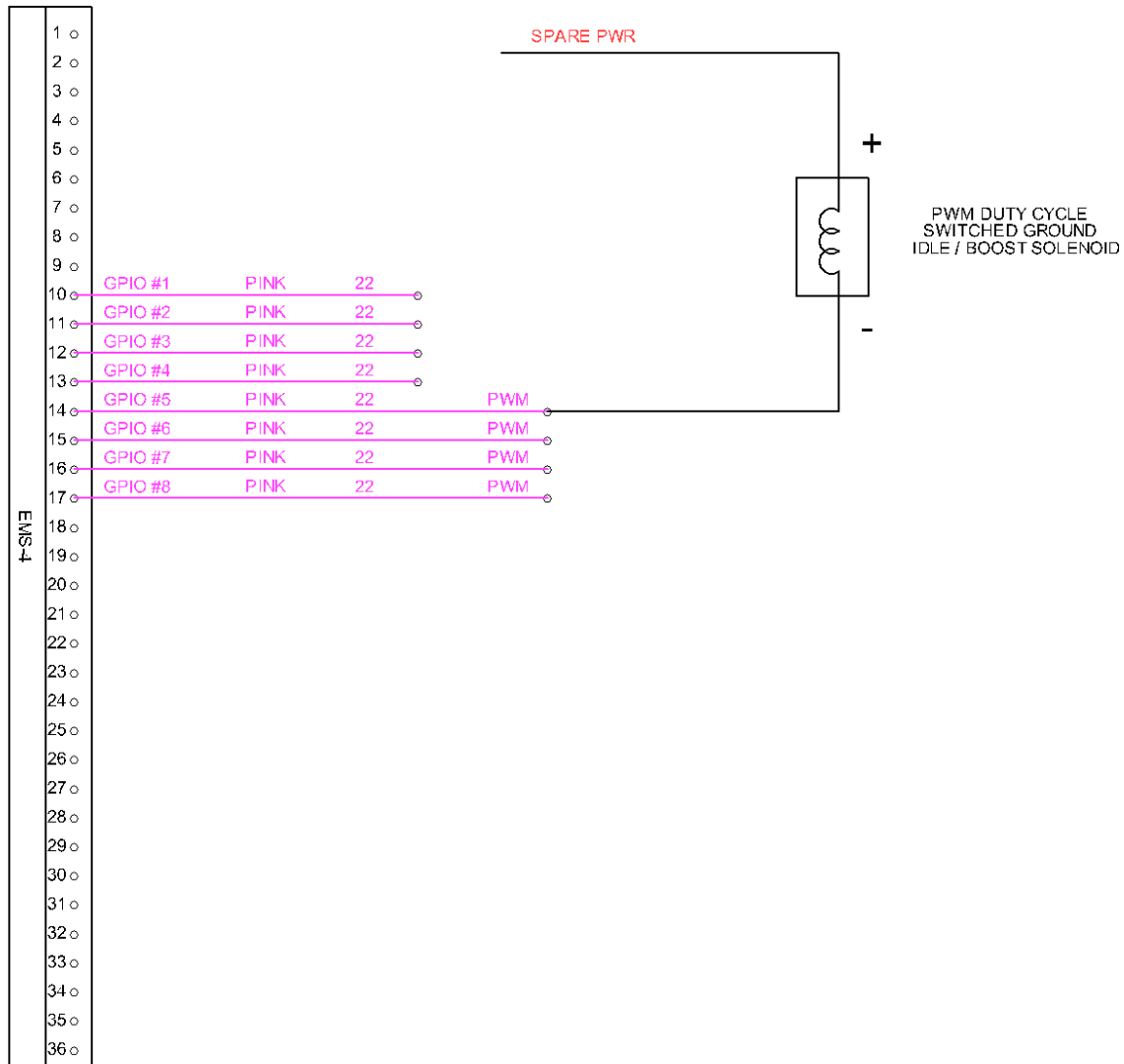

The example above illustrates a GPIO as a PWM duty cycle output such as an idle air control solenoid or boost control solenoid.

The power input to the solenoid must not be connected directly to the battery or any full time voltage source. The power should come from a switched fused supply. See the EMS-4 System Diagram for more information.

Name	Value	Unit
Idle PW Output	GPIO5	
Idle PW Frequency	33000.0	μS
GPIO5 40/64Mhz	OFF	

Idle PW Output – Option assigning pin GPIO5 to the Idle Control output function

Idle PW Frequency – The period in microseconds assigned to this output pin.

1 microsecond = 0.000001 seconds or 1×10^{-6} seconds

$33000 \times 1 \times 10^{-6}$ seconds = 0.033 seconds

Frequency = $1 / \text{Period}$ so:

$1/0.033 = 30.3$ Hz

These setting would configure the EMS to output a 30 Hz duty cycle switched ground output on pin GPIO5.

GPIO5 40/64Mhz – Scaling option sometimes used to allow much higher frequency output signals. Default is OFF.

Note that a power cycle is necessary for these settings to take effect.

GPIO as Switched Input example

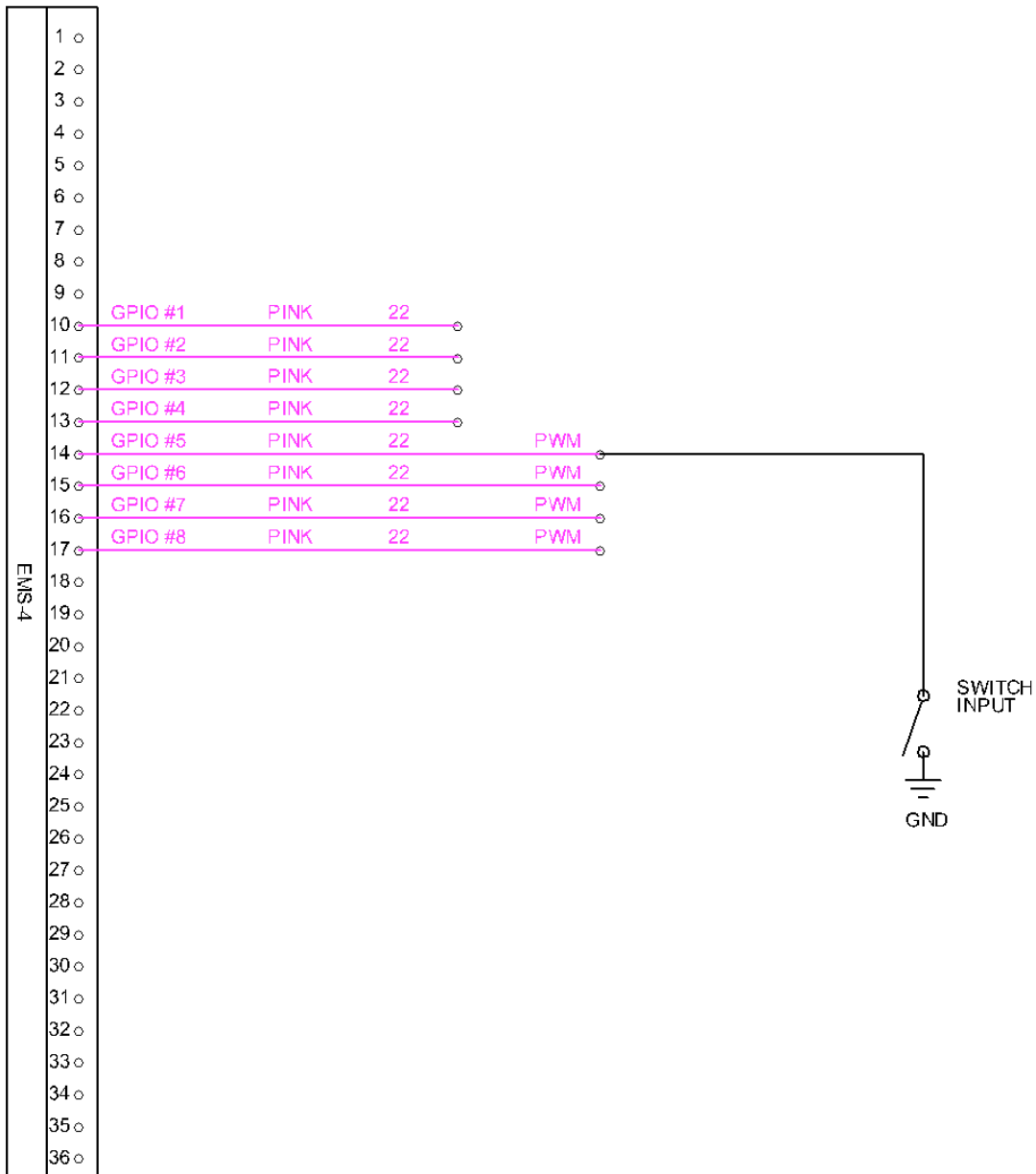

The example above illustrates a GPIO as a switch input for use in activating certain EMS functions.

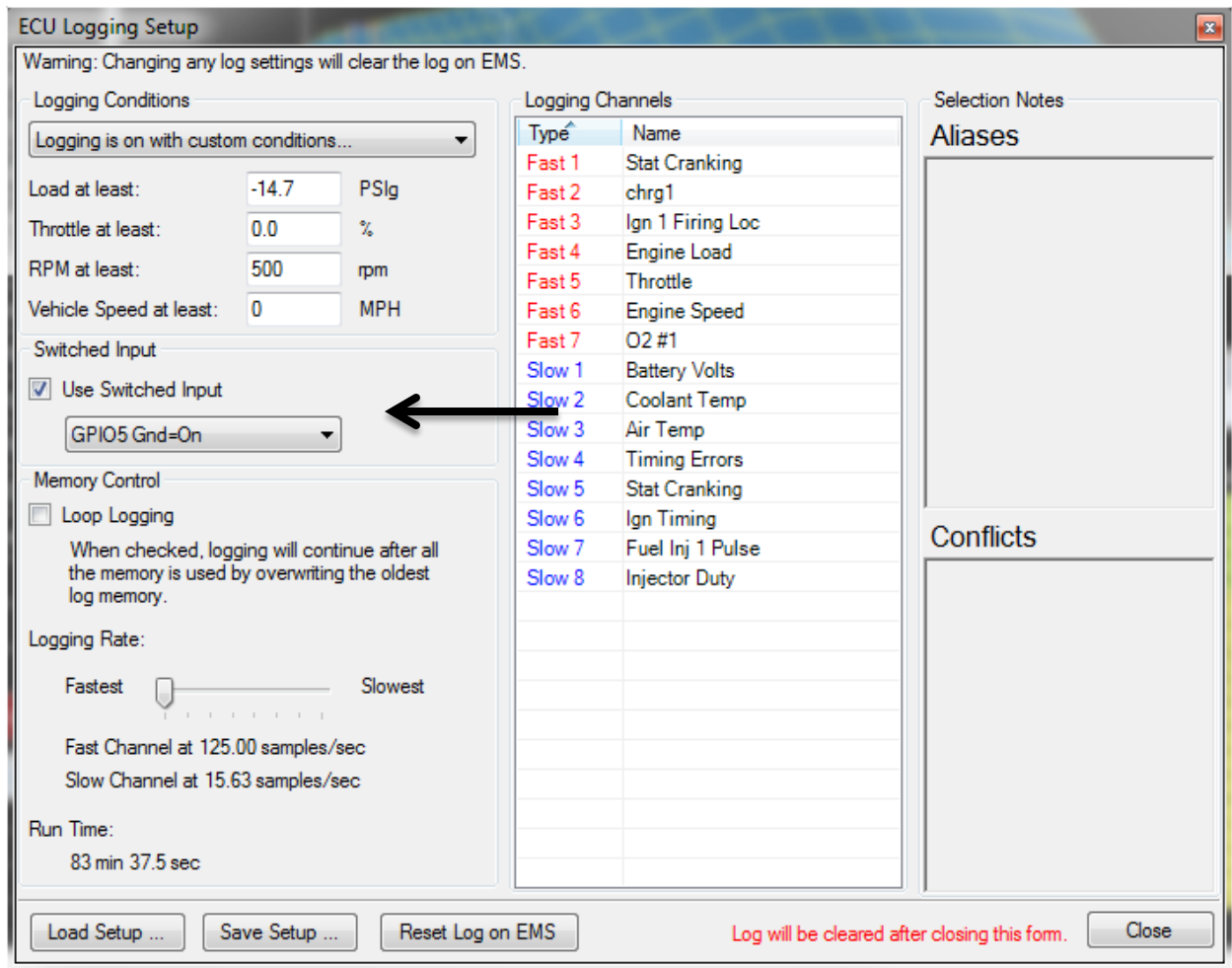

In the example above, GPIO5 is defined as the internal logging activation switch input. The **Gnd=On** criteria is set meaning the switch input will be considered on when the switch completes continuity to ground as shown in the diagram above.

The analog status of all GPIO pins can be monitored by viewing/logging the GPIOX AN channel as shown below:

Logging	OFF	
GPIO5 AN	4.09	Volts

← Logging Off

← Switch High

Logging	ON	
GPIO5 AN	0.00	Volts

← Logging On

← Switch Low (GND)

GPIO as simple switched output driver example

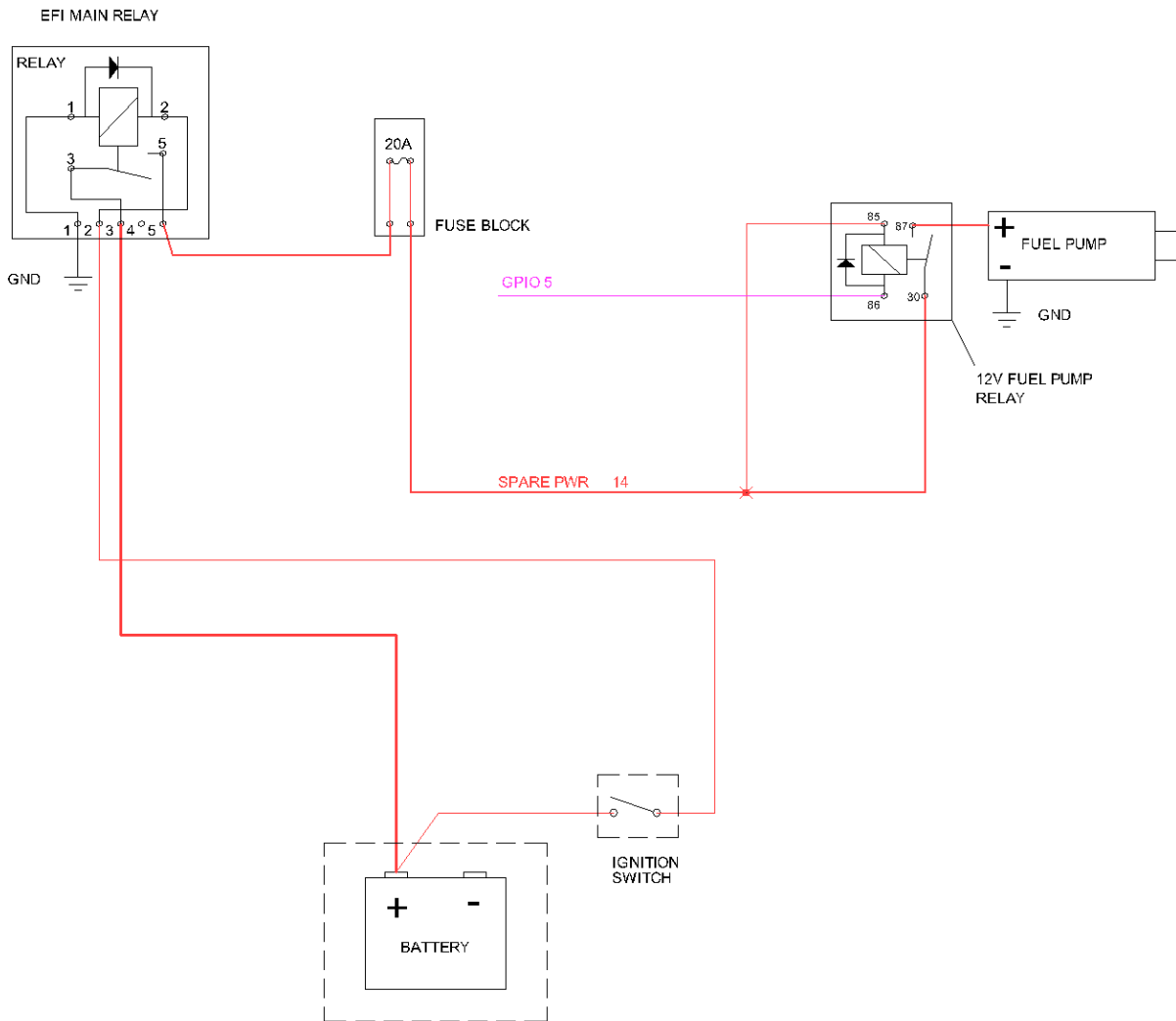

In the example above, GPIO5 is setup as a simple switched output driver to activate a fuel pump relay.

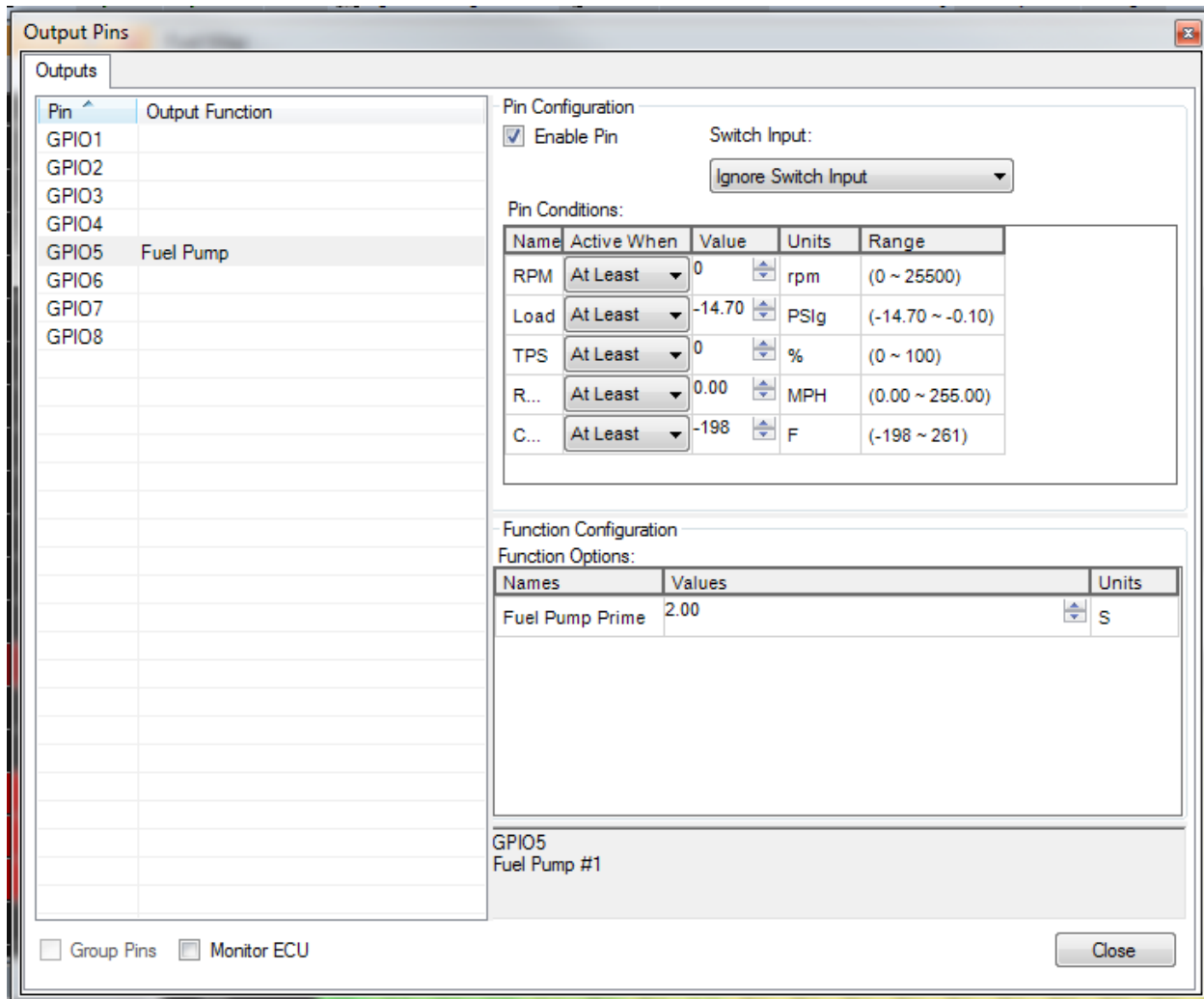

As shown above, GPIO5 is set up as a fuel pump function output. It will follow all rules associated with a fuel pump function:

1. At power up, the output will activate and stay on for the length of time defined for **Fuel Pump Prime** above.
2. If no crank tooth pulses are detected, the output will turn off.
3. If crank tooth pulses are detected (engine spinning), the output will turn on to activate the fuel pump.

GPIO as simple 0-5V analog input example

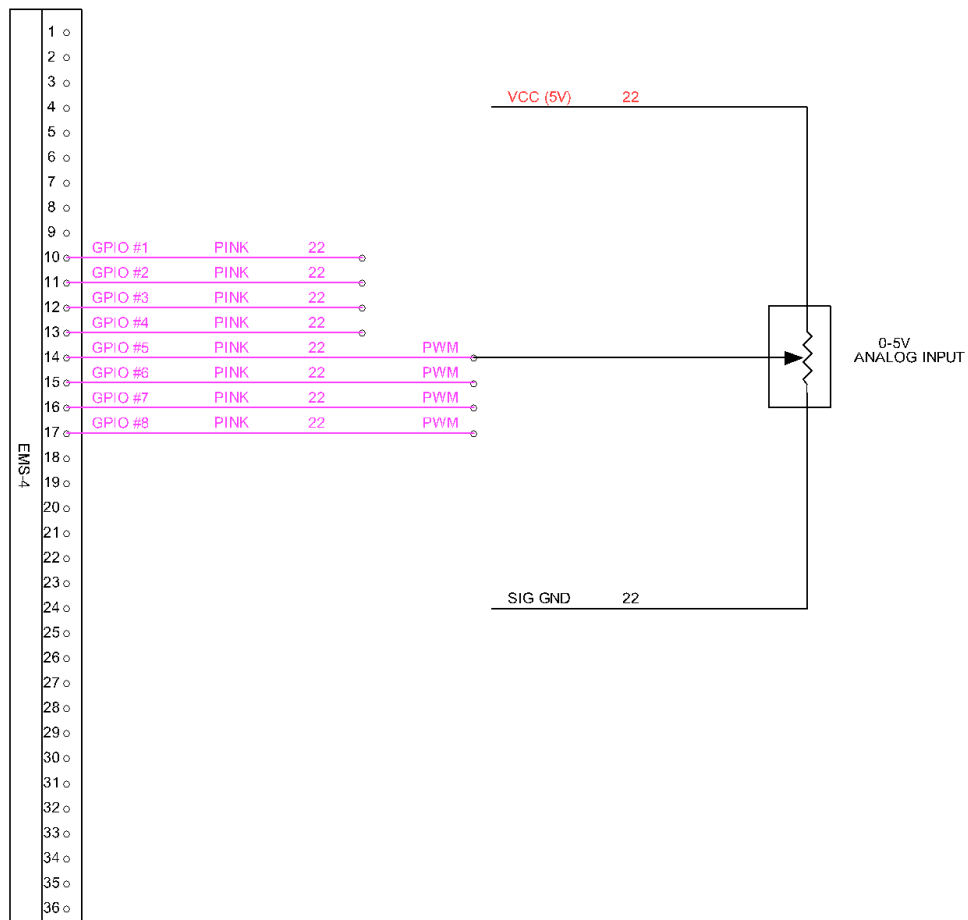

GPIO as Analog Input combined with Other Functions

Tuning Tip The following is a creative example of how the GPIOs can be combined and used with other software functions to accomplish complex objectives.

GPIO setup:

- GPIO5 as an analog input (0-5V fuel pressure transducer)
- GPIO1 as a simple switched output driver (warning lamp)

EMS functions combined:

- Alt function
- Analog Switch 7

Goal: Activate a function that retards ignition timing by a certain amount, adds a fuel trim and activates a warning light when the fuel pressure falls below a safe level.

System Schematic

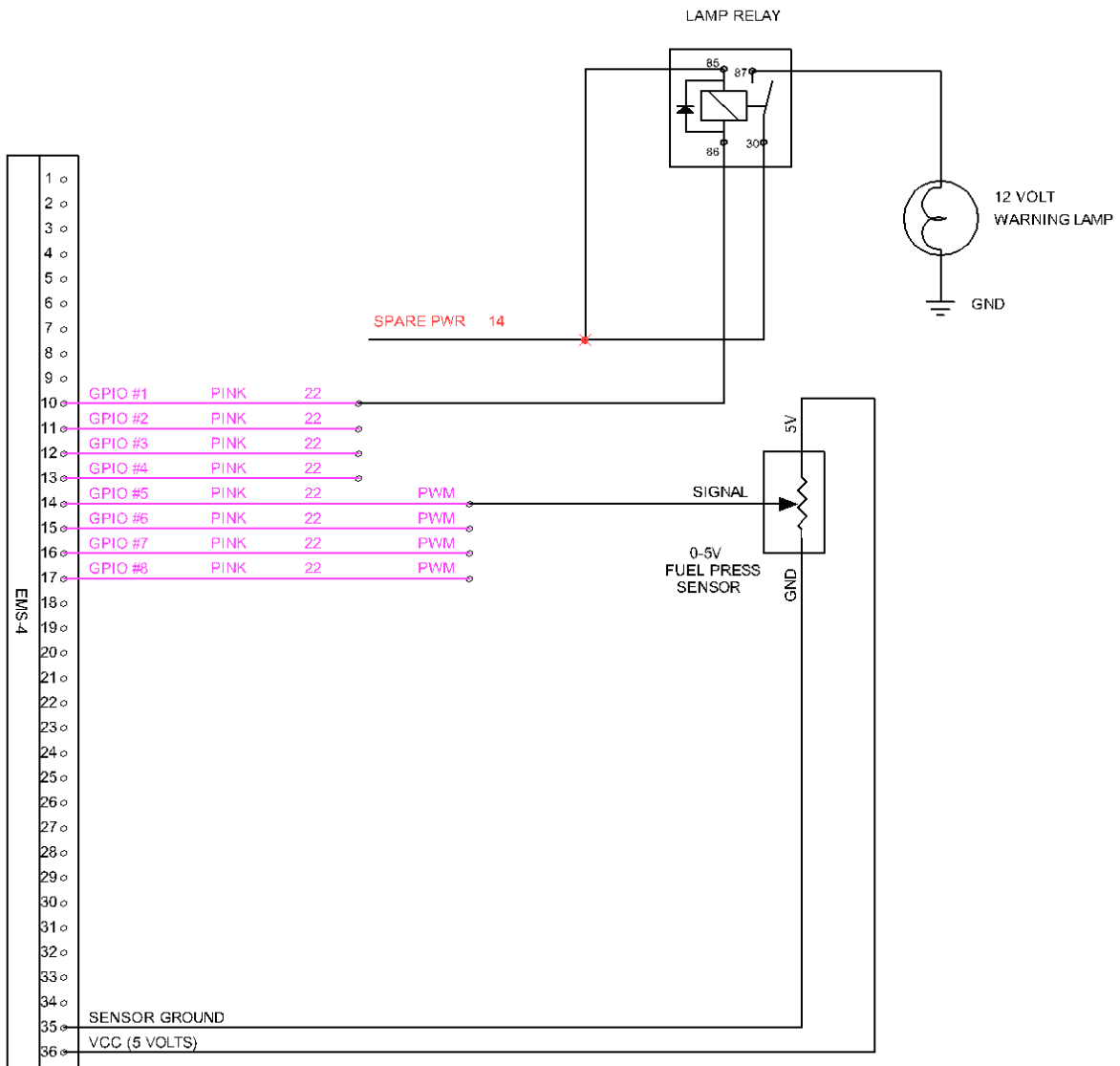

Switch 7 Setup Options

Name	Value	Unit
Switch 7 Analog In	GPIO5 Volts	
Switch 7 On Above	5.08	Volts
Switch 7 On Below	3.51	Volts
Switch 7 Min RPM	500	rpm
Switch 7 Min TPS	50.0	%

Switch 7 is a user created switch analog input channel. Once all conditions have been met, it activates an internal channel that is broadcast in the EMS and can be used as activation trigger for any logic that can take a manual/electrical switch input as an activating condition.

Switch 7 Analog In – The input pin assigned to the Switch 7 Function

Switch 7 On Above - Voltage threshold above which the switch 7 function is ON.

Switch 7 On Below – Voltage threshold below which the switch 7 function is ON.

Switch 7 Min RPM – RPM threshold above which the switch 7 function is ON.

Switch 7 Min TPS – TPS threshold above which the switch 7 function is ON.

The settings in the example above will cause the Switch 7 function to turn on when:

- The GPIO5 voltage is either above 5.08 volts (unattainable condition) or below 3.51 volts and:
- The engine speed is above 500 RPM and:
- The throttle position is above 50%

In this theoretical example, 3.51 volts represents the safe minimum voltage for the fuel pressure sensor input on GPIO5.

Alt Function Setup Options

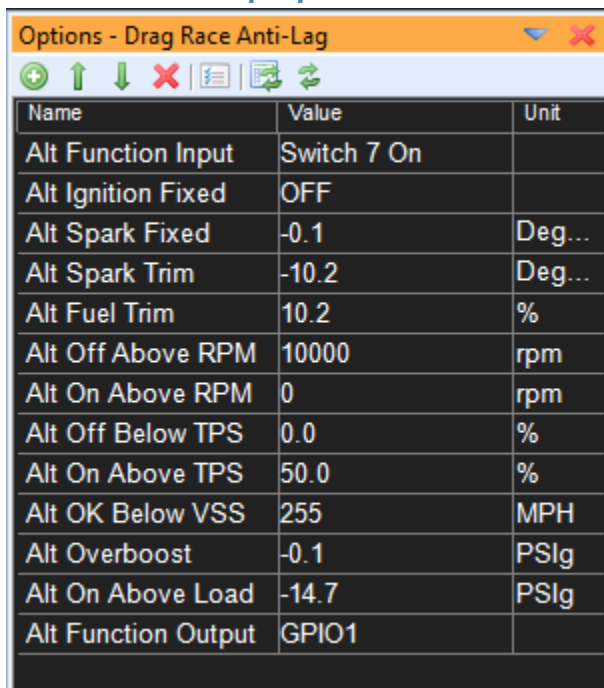

Name	Value	Unit
Alt Function Input	Switch 7 On	
Alt Ignition Fixed	OFF	
Alt Spark Fixed	-0.1	Deg...
Alt Spark Trim	-10.2	Deg...
Alt Fuel Trim	10.2	%
Alt Off Above RPM	10000	rpm
Alt On Above RPM	0	rpm
Alt Off Below TPS	0.0	%
Alt On Above TPS	50.0	%
Alt OK Below VSS	255	MPH
Alt Overboost	-0.1	PSIg
Alt On Above Load	-14.7	PSIg
Alt Function Output	GPIO1	

The Alt Function is another unique feature of the EMS. It's most often used in conjunction with the 2 step rev limiter to create a turbocharger anti-lag function. A turbocharged drag race vehicle can use this function to build boost on the starting line. The Alt function when activated can retard the ignition timing and add fuel effectively turning the turbine housing into a fuel afterburner. This adds tremendous energy to the turbocharger and increases turbine speed, building boost. In this example, we are simply using the function to trim fuel and spark and activate a switched ground output at the same time.

Alt Function Input – Channel that activates the alternative trims.

Alt Ignition Fixed - Enables the fixed ignition state where the user can force the ignition timing to a fixed value regardless of any other influence.

Alt Spark Fixed - Defines the fixed ignition timing value in degrees when option Alt Ignition Fixed enabled.

Alt Spark Trim - Amount of ignition spark to be trimmed (+/-) when the alternate trims are active.

Alt Fuel Trim - Percentage of fuel to be added when in the alternate switched condition.

Alt Off Above RPM - When above this rpm, the alternate trims and functions will deactivate.

Alt On Above RPM - When above this rpm, but below the Alt Off Above RPM, the alternate trims and functions will activate.

Alt Off Below TPS – When below this value, the alternate trims and functions will deactivate.

Alt On Above TPS – When above this value, the alternate trims and functions will activate.

Alt OK Below VSS – The maximum vehicle speed threshold for the Alt Function.

Alt Overboost - When above this value, the alternate trims and functions will deactivate.

Alt On Above Load - When above this load value, but below the Alt Overboost value, the alternate trims and functions will activate.

Alt Function Output - If the Alt function is activated, this output channel will be activated also. Can be used to drive an LED, injector or whatever.

In our example, if above 50% throttle and 500 RPM AND the GPIO5 analog voltage falls below 3.51 volts, Switch 7 will turn on activating the Alt Function. The alt function will retard the ignition timing by 10.2 degrees and add 10% to the current fuel pulse. The ALT function will also activate low side switch GPIO1 which can be used to drive a warning lamp relay.

Data logging

All EMS systems feature two methods for data logging. One is called “PC Logging” where the AEM Tuner software records data displayed on-screen directly to the PC memory. The other is called “Internal Logging” and uses on-board logging memory within the ECU to store data. The data logging setup is saved as part of the calibration file and must be configured properly to work.

PC Logging

When AEMTuner is connected to an ECU, it can log the Channel data it is receiving from the ECU into a PC Data-Log. The Channels that are displayed in any Channel Displays on the current Display Sheet are the Channels that will be logged. If the user tries to close a Channels Display, open a Channels Display, or change the current Display Sheet the system will alert the user that they are PC Data-Logging, and request they either stop Logging and save the data, or cancel the operation they are trying to do. When Logging is started the PC Data-Logging On Icon will be activated in the Status Bar.

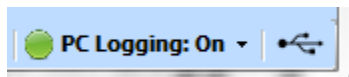

Left clicking on the drop down arrow shown above will display the following menu:

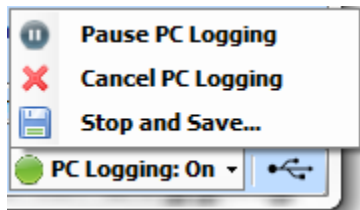

Pause/Resume PC Logging: PC Data-Logging may be paused, meaning that data from the ECU is not recorded in the log, and the values in the Channels Displays are not updated.

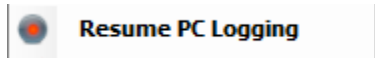

Resuming causes both channel data to be recorded again, and the values in the Channels Displays to be updated.

Cancel PC Logging: Cancelling a PC Log means that PC Data Logging is stopped, and the data collected thus far is discarded and not saved to a file. AEMTuner remains connected to the ECU when a PC Log is deleted.

Stop and Save: is used to stop and save the data logged to a file. After Logging is stopped the ECU stays connected. When PC Data-Logging the logging rate is fixed at 50 hz.

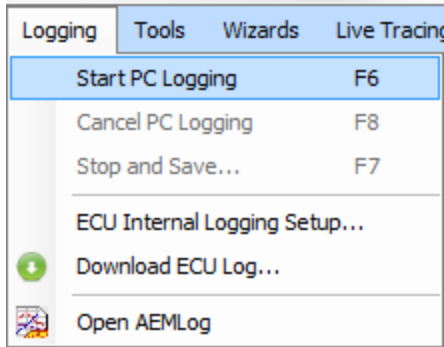

To begin a PC log, AEM Tuner must be connected to the ECU. Select Start PC Logging from the menu item above or hit the F6 key.

Select Stop and Save from either the menu items above or the status bar logging item.

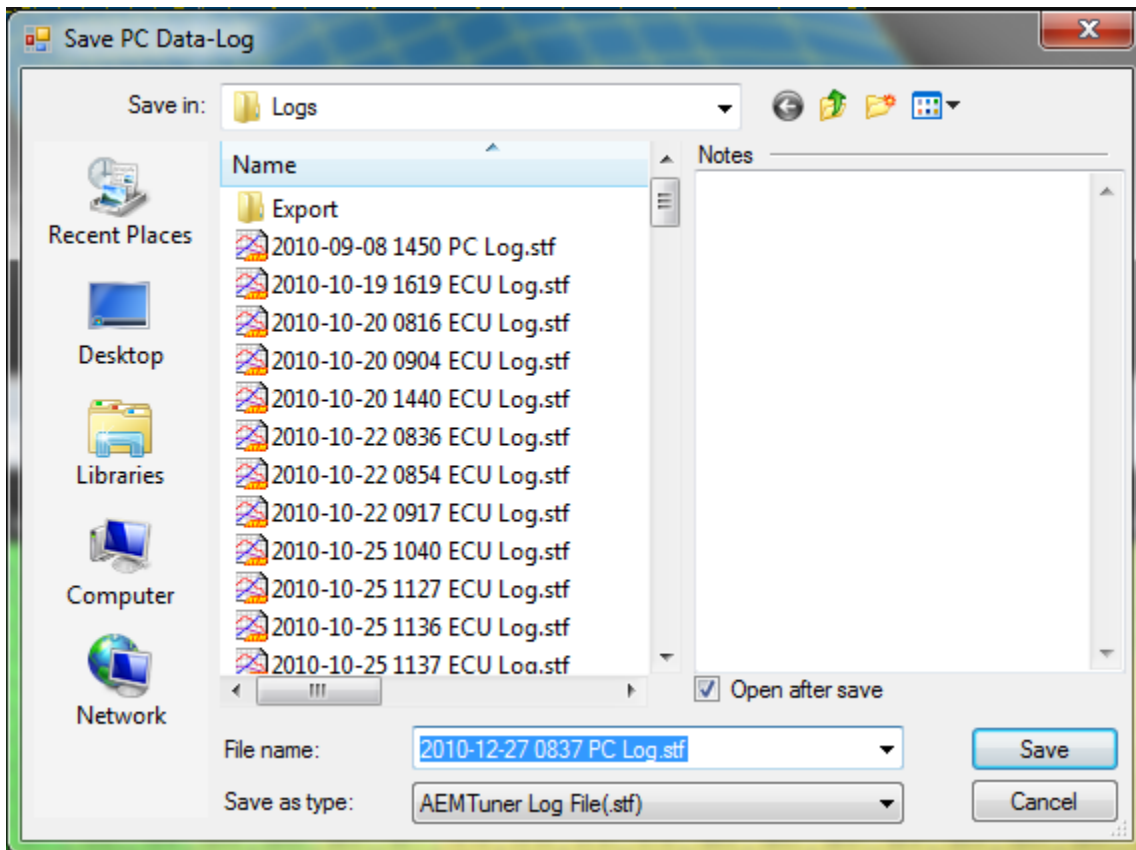

The dialog above will be displayed prompting the user to assign a file name to the log or accept the default log file name.

Note that default filenames can be selected from the Preferences Menu Item under the Logging sub-category as shown below:

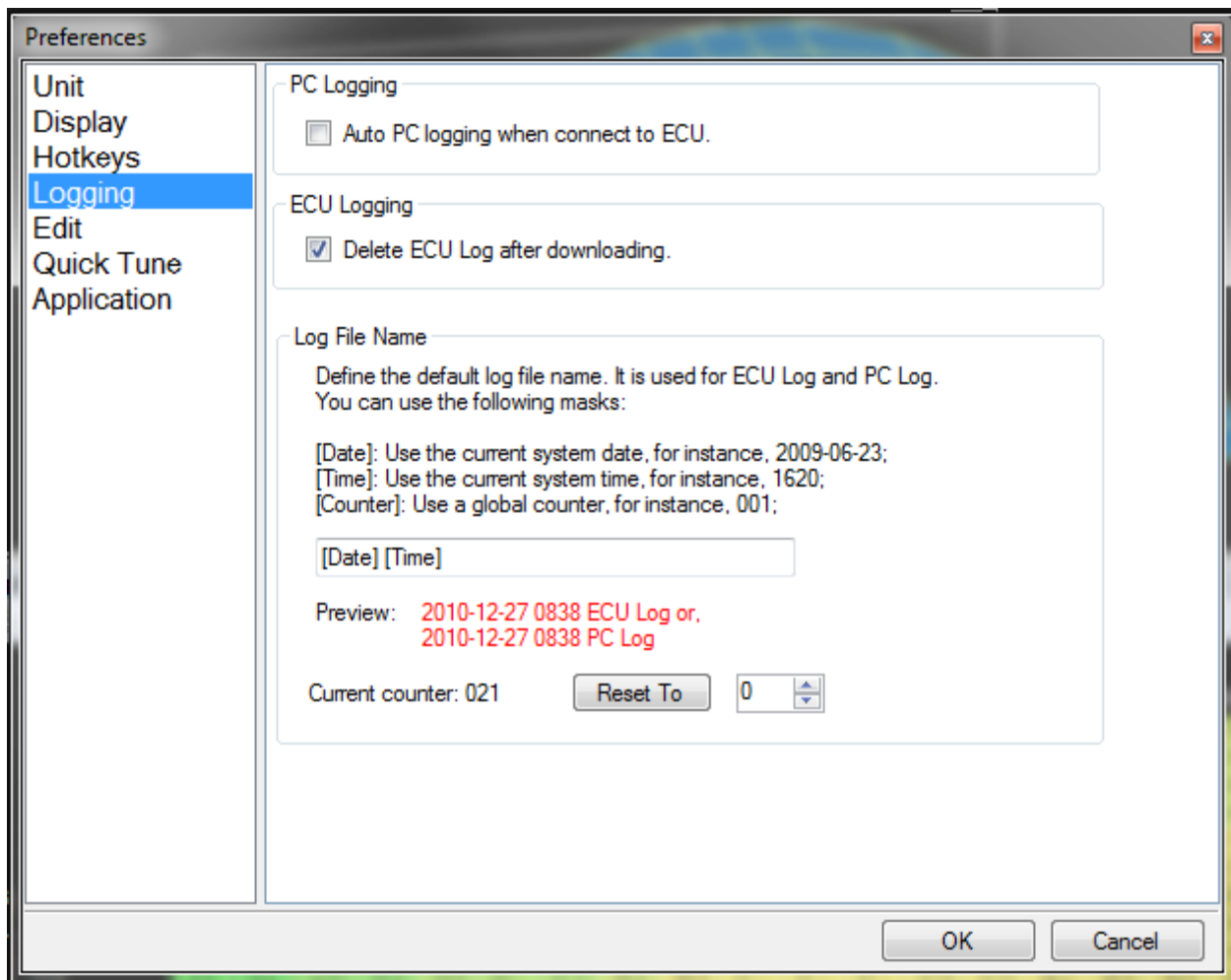

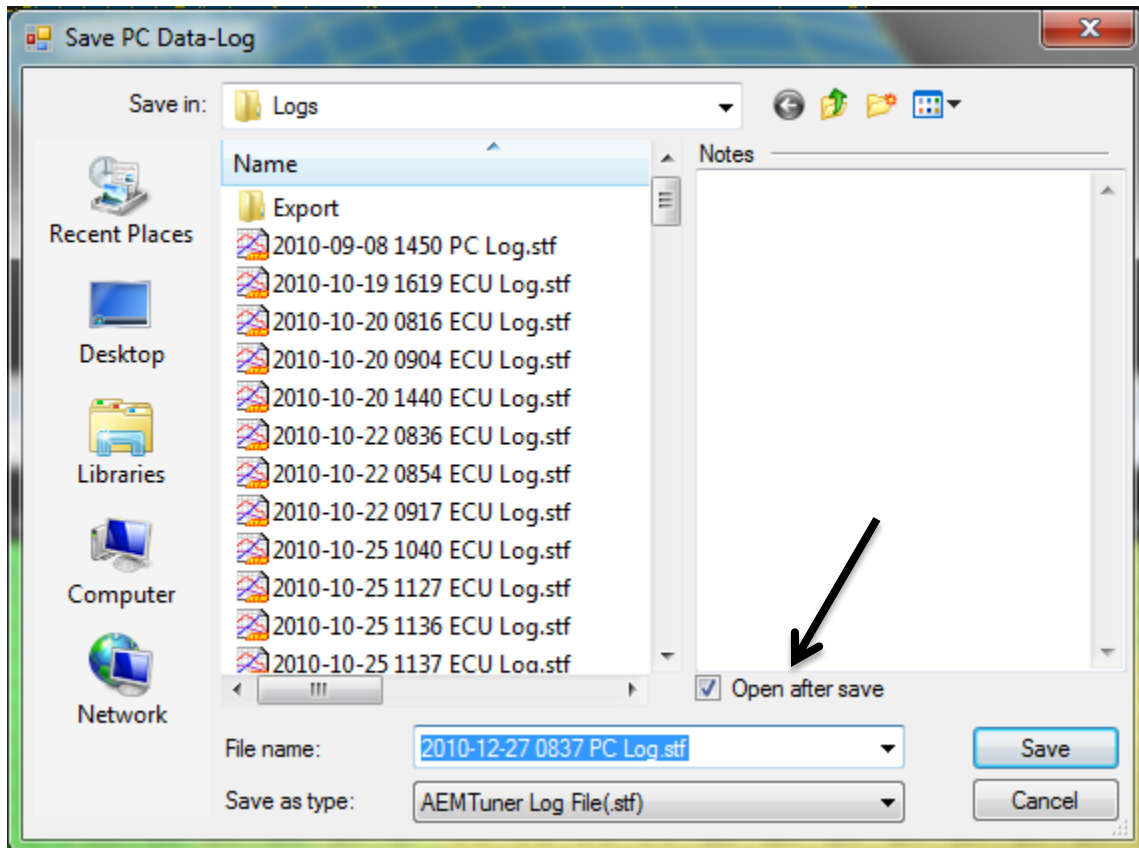

The Open after save selection prompts AEM Tuner to automatically launch AEM Log software after the file save. For more information on using the included data analysis package, AEM Log, see the included AEM Log User's Guide in the Instructions folder in the AEM Tuner directory.

Internal Logging

All Series 2 EMS controllers with the exception of the EMS-4 include 1Mb of internal logging memory. The EMS-4 features 8Mb of internal memory space.

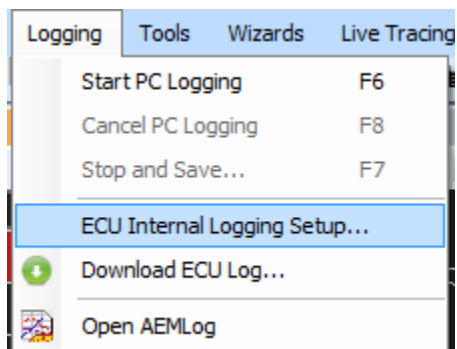

ECU Internal Logging Setup – Opens a dialog window that allows the user to configure the internal logging settings of the EMS.

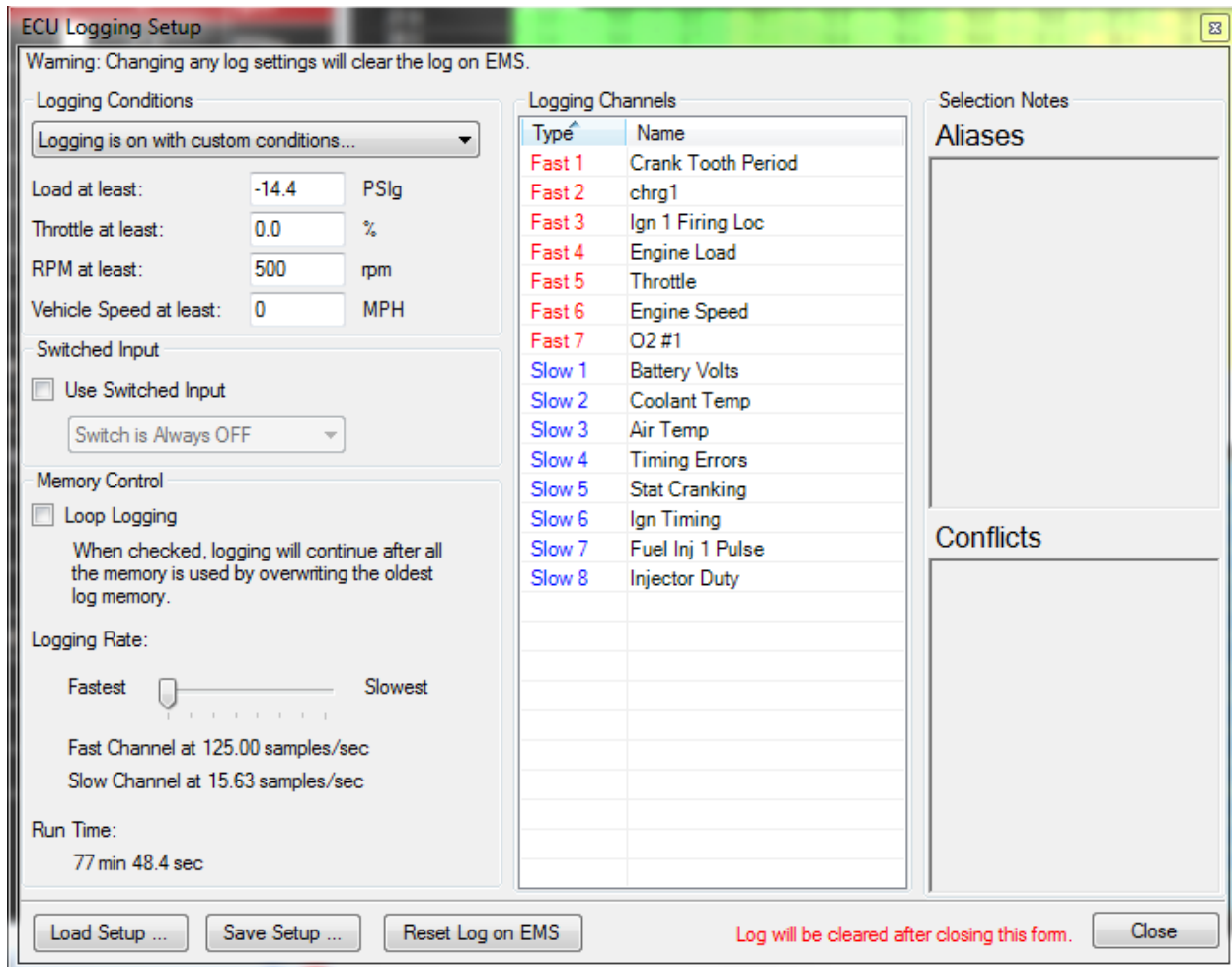

EMS Internal Logging Setup Dialog

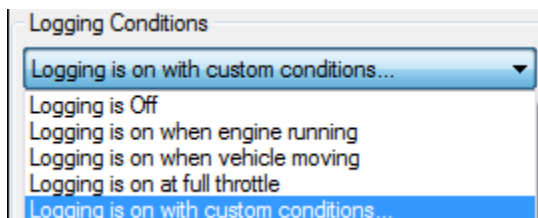

Logging Conditions

Logging Conditions – Defines the activation criteria for the internal logging function.

Logging is Off – Internal logging function is disabled.

Logging is on when engine is running – When engine speed is greater than 0, data will be logged.

Logging is on when the vehicle is moving – When the vehicle speed is greater than 0, data will be logged. Note that this setting requires a properly configured vehicle speed sensor.

Logging is on at full throttle – Data will be logged at wide open throttle only.

Logging is on with custom conditions – Logging activation is determined by the following settings:

Load at least:	<input type="text" value="-14.4"/>	PSIg
Throttle at least:	<input type="text" value="0.0"/>	%
RPM at least:	<input type="text" value="500"/>	rpm
Vehicle Speed at least:	<input type="text" value="0"/>	MPH

Logging Custom Conditions

Switched Input

Use Switched Input

Switch is Always OFF

Switch is Always ON

GPIO1 Gnd=On

GPIO1 12V=On

GPIO2 Gnd=On

GPIO2 12V=On

GPIO3 Gnd=On

GPIO3 12V=On

GPIO4 Gnd=On

GPIO4 12V=On

Log Switch Settings

Select *Use Switched Input* to define a log activation switch input from the drop down list.

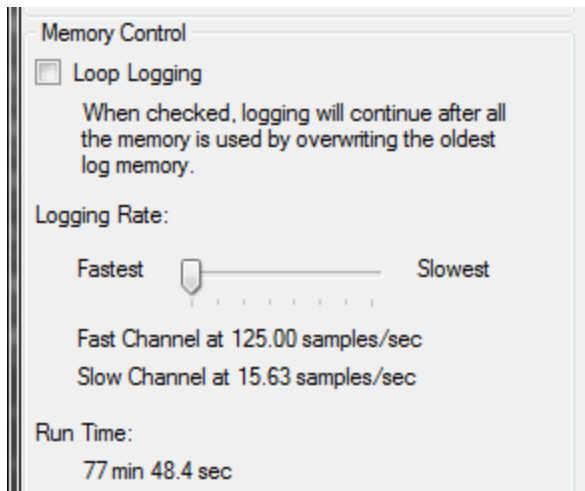

Internal Logging Memory Control

Select *Loop Logging* to continue logging after all memory is used. Only the oldest data will be lost when the log loops.

Use the slider to select the logging rate. The rate, channels selected and EMS logging memory capacity will be used to estimate the log run time.

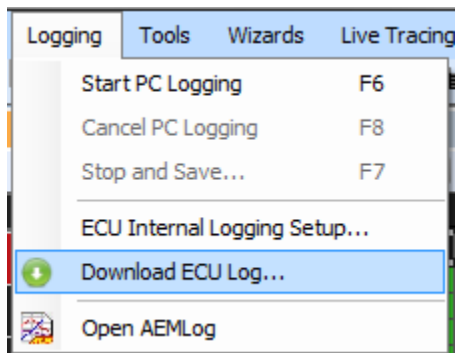

Download EMS Log Menu Item

Download EMS Log – Select this item when connected to the EMS to download the current logged data file. **NOTE: For EMS-4 applications only, please wait 30 seconds after an ECU power reset before downloading internal log data.**

Open AEMLog – Select this item to Open AEMLog data analysis software.

Advanced Tuning

Boost Control

The AEM EMS has a very comprehensive and flexible boost control function. Using a pulse width actuated solenoid, boost can be controlled by vehicle speed, throttle position against rpm, and a switch input for low and high settings. The first step in creating a new setup is determining what frequency the solenoid needs to be operated. This information is typically provided by the manufacturer of the part. If you are using a plug n' play with a factory boost control solenoid, this comes preconfigured by AEM.

The PWM output pin needs to be determined when installing a boost solenoid. Refer to the Application Notes for the pinouts of the specific EMS used. This information can also be found on the AEM EMS forum (www.aempower.com). There are two wire connections for a boost solenoid and there is no polarity. One wire connects to 12 volt switched power and the other will connect to the PWM output on the EMS.

The following example setup shows how to configure the GPIO7 output on an EMS-4 for use in the Boost Control function:

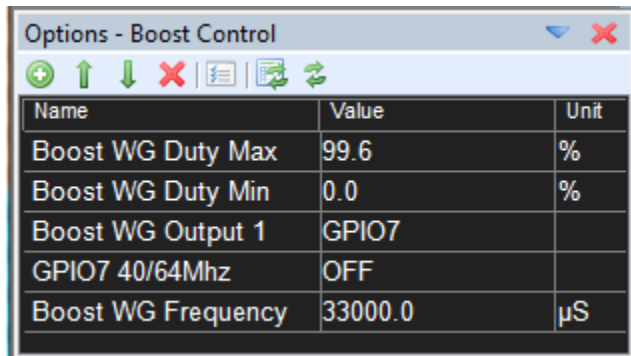

Name	Value	Unit
Boost WG Duty Max	99.6	%
Boost WG Duty Min	0.0	%
Boost WG Output 1	GPIO7	
GPIO7 40/64Mhz	OFF	
Boost WG Frequency	33000.0	µS

Boost WG Duty Max – Defines maximum duty cycle for boost control output.

Boost WG Duty Min – Defines minimum duty cycle for boost control output

Boost WG Output 1 – Defines the output pin to be used for the boost control function, in this case GPIO7. Remember that on EMS-4 applications, only outputs GPIO5 through GPIO8 can be used for PWM/Duty cycle control outputs.

GPIO7 40/64Mhz – Scaling function to increase frequency range. Internal AEM use only. Default setting is OFF.

Boost WG Frequency – Defines the period in microseconds for this output.

1 microsecond = 0.000001 seconds or 1×10^{-6} seconds

$33000 \times 1 \times 10^{-6}$ seconds = 0.033 seconds

Frequency = 1 / Period so:

$$1/0.033 = 30.3 \text{ Hz}$$

These setting would configure the EMS to output a 30 Hz duty cycle switched ground output on pin GPIO7.

Boost WG Base Duty		RPM (rpm)																			
Boost WG Ba:	800	1000	1200	1400	1600	1800	2000	2200	2400	2600	2800	3000	3500	4000	4500	5000	5500	6000	6500	7500	8500
35.2	50.0	50.0	50.0	50.0	50.0	50.0	50.0	50.0	50.0	50.0	50.0	50.0	50.0	50.0	50.0	50.0	50.0	50.0	50.0	50.0	50.0
32.2	50.0	50.0	50.0	50.0	50.0	50.0	50.0	50.0	50.0	50.0	50.0	50.0	50.0	50.0	50.0	50.0	50.0	50.0	50.0	50.0	50.0
28.9	50.0	50.0	50.0	50.0	50.0	50.0	50.0	50.0	50.0	50.0	50.0	50.0	50.0	50.0	50.0	50.0	50.0	50.0	50.0	50.0	50.0
25.6	50.0	50.0	50.0	50.0	50.0	50.0	50.0	50.0	50.0	50.0	50.0	50.0	50.0	50.0	50.0	50.0	50.0	50.0	50.0	50.0	50.0
22.3	50.0	50.0	50.0	50.0	50.0	50.0	50.0	50.0	50.0	50.0	50.0	50.0	50.0	50.0	50.0	50.0	50.0	50.0	50.0	50.0	50.0
18.9	50.0	50.0	50.0	50.0	50.0	50.0	50.0	50.0	50.0	50.0	50.0	50.0	50.0	50.0	50.0	50.0	50.0	50.0	50.0	50.0	50.0
15.6	50.0	50.0	50.0	50.0	50.0	50.0	50.0	50.0	50.0	50.0	50.0	50.0	50.0	50.0	50.0	50.0	50.0	50.0	50.0	50.0	50.0
13.9	50.0	50.0	50.0	50.0	50.0	50.0	50.0	50.0	50.0	50.0	50.0	50.0	50.0	50.0	50.0	50.0	50.0	50.0	50.0	50.0	50.0
12.1	50.0	50.0	50.0	50.0	50.0	50.0	50.0	50.0	50.0	50.0	50.0	50.0	50.0	50.0	50.0	50.0	50.0	50.0	50.0	50.0	50.0
10.5	50.0	50.0	50.0	50.0	50.0	50.0	50.0	50.0	50.0	50.0	50.0	50.0	50.0	50.0	50.0	50.0	50.0	50.0	50.0	50.0	50.0
8.8	50.0	50.0	50.0	50.0	50.0	50.0	50.0	50.0	50.0	50.0	50.0	50.0	50.0	50.0	50.0	50.0	50.0	50.0	50.0	50.0	50.0
7.2	50.0	50.0	50.0	50.0	50.0	50.0	50.0	50.0	50.0	50.0	50.0	50.0	50.0	50.0	50.0	50.0	50.0	50.0	50.0	50.0	50.0
5.4	50.0	50.0	50.0	50.0	50.0	50.0	50.0	50.0	50.0	50.0	50.0	50.0	50.0	50.0	50.0	50.0	50.0	50.0	50.0	50.0	50.0
3.7	50.0	50.0	50.0	50.0	50.0	50.0	50.0	50.0	50.0	50.0	50.0	50.0	50.0	50.0	50.0	50.0	50.0	50.0	50.0	50.0	50.0
2.1	50.0	50.0	50.0	50.0	50.0	50.0	50.0	50.0	50.0	50.0	50.0	50.0	50.0	50.0	50.0	50.0	50.0	50.0	50.0	50.0	50.0
-1.2	50.0	50.0	50.0	50.0	50.0	50.0	50.0	50.0	50.0	50.0	50.0	50.0	50.0	50.0	50.0	50.0	50.0	50.0	50.0	50.0	50.0
-4.5	50.0	50.0	50.0	50.0	50.0	50.0	50.0	50.0	50.0	50.0	50.0	50.0	50.0	50.0	50.0	50.0	50.0	50.0	50.0	50.0	50.0

The **Boost WG Base Duty** table example above contains a 50% duty cycle setting everywhere. This table combined with the options above will result in the following output waveform on the GPIO7 pin after a power cycle:

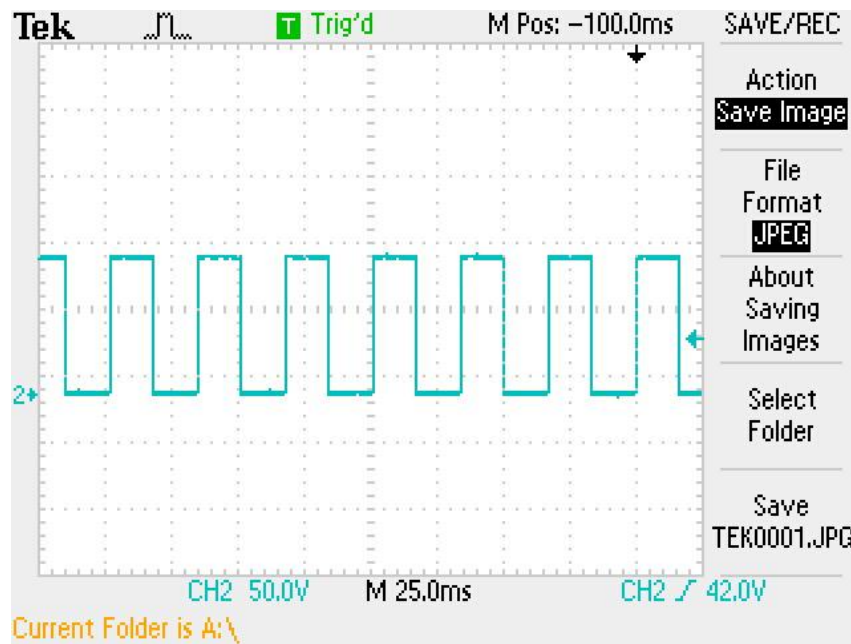

This is a 30Hz, 50% duty cycle signal. The solenoid will be ON when the signal is low and OFF when the signal is high.

Inverting the output

The PWM output can be inverted to allow more flexibility in the plumbing configuration. The **Boost WG 1 Invert** option will control the output configuration. The example below is setup with a flat 20% duty cycle in the Base Duty table:

Boost WG Base Duty		RPM (rpm)																			
Boost WG Ba:	800	1000	1200	1400	1600	1800	2000	2200	2400	2600	2800	3000	3500	4000	4500	5000	5500	6000	6500	7500	8500
35.2	19.9	19.9	19.9	19.9	19.9	19.9	19.9	19.9	19.9	19.9	19.9	19.9	19.9	19.9	19.9	19.9	19.9	19.9	19.9	19.9	19.9
32.2	19.9	19.9	19.9	19.9	19.9	19.9	19.9	19.9	19.9	19.9	19.9	19.9	19.9	19.9	19.9	19.9	19.9	19.9	19.9	19.9	19.9
28.9	19.9	19.9	19.9	19.9	19.9	19.9	19.9	19.9	19.9	19.9	19.9	19.9	19.9	19.9	19.9	19.9	19.9	19.9	19.9	19.9	19.9
25.6	19.9	19.9	19.9	19.9	19.9	19.9	19.9	19.9	19.9	19.9	19.9	19.9	19.9	19.9	19.9	19.9	19.9	19.9	19.9	19.9	19.9
22.3	19.9	19.9	19.9	19.9	19.9	19.9	19.9	19.9	19.9	19.9	19.9	19.9	19.9	19.9	19.9	19.9	19.9	19.9	19.9	19.9	19.9
18.9	19.9	19.9	19.9	19.9	19.9	19.9	19.9	19.9	19.9	19.9	19.9	19.9	19.9	19.9	19.9	19.9	19.9	19.9	19.9	19.9	19.9
15.6	19.9	19.9	19.9	19.9	19.9	19.9	19.9	19.9	19.9	19.9	19.9	19.9	19.9	19.9	19.9	19.9	19.9	19.9	19.9	19.9	19.9
13.9	19.9	19.9	19.9	19.9	19.9	19.9	19.9	19.9	19.9	19.9	19.9	19.9	19.9	19.9	19.9	19.9	19.9	19.9	19.9	19.9	19.9
12.1	19.9	19.9	19.9	19.9	19.9	19.9	19.9	19.9	19.9	19.9	19.9	19.9	19.9	19.9	19.9	19.9	19.9	19.9	19.9	19.9	19.9
10.5	19.9	19.9	19.9	19.9	19.9	19.9	19.9	19.9	19.9	19.9	19.9	19.9	19.9	19.9	19.9	19.9	19.9	19.9	19.9	19.9	19.9
8.8	19.9	19.9	19.9	19.9	19.9	19.9	19.9	19.9	19.9	19.9	19.9	19.9	19.9	19.9	19.9	19.9	19.9	19.9	19.9	19.9	19.9
7.2	19.9	19.9	19.9	19.9	19.9	19.9	19.9	19.9	19.9	19.9	19.9	19.9	19.9	19.9	19.9	19.9	19.9	19.9	19.9	19.9	19.9
5.4	19.9	19.9	19.9	19.9	19.9	19.9	19.9	19.9	19.9	19.9	19.9	19.9	19.9	19.9	19.9	19.9	19.9	19.9	19.9	19.9	19.9
3.7	19.9	19.9	19.9	19.9	19.9	19.9	19.9	19.9	19.9	19.9	19.9	19.9	19.9	19.9	19.9	19.9	19.9	19.9	19.9	19.9	19.9
2.1	19.9	19.9	19.9	19.9	19.9	19.9	19.9	19.9	19.9	19.9	19.9	19.9	19.9	19.9	19.9	19.9	19.9	19.9	19.9	19.9	19.9
-1.2	19.9	19.9	19.9	19.9	19.9	19.9	19.9	19.9	19.9	19.9	19.9	19.9	19.9	19.9	19.9	19.9	19.9	19.9	19.9	19.9	19.9
-4.5	19.9	19.9	19.9	19.9	19.9	19.9	19.9	19.9	19.9	19.9	19.9	19.9	19.9	19.9	19.9	19.9	19.9	19.9	19.9	19.9	19.9

Boost WG 1 Invert OFF

The setup above will result in the following output signal pattern:

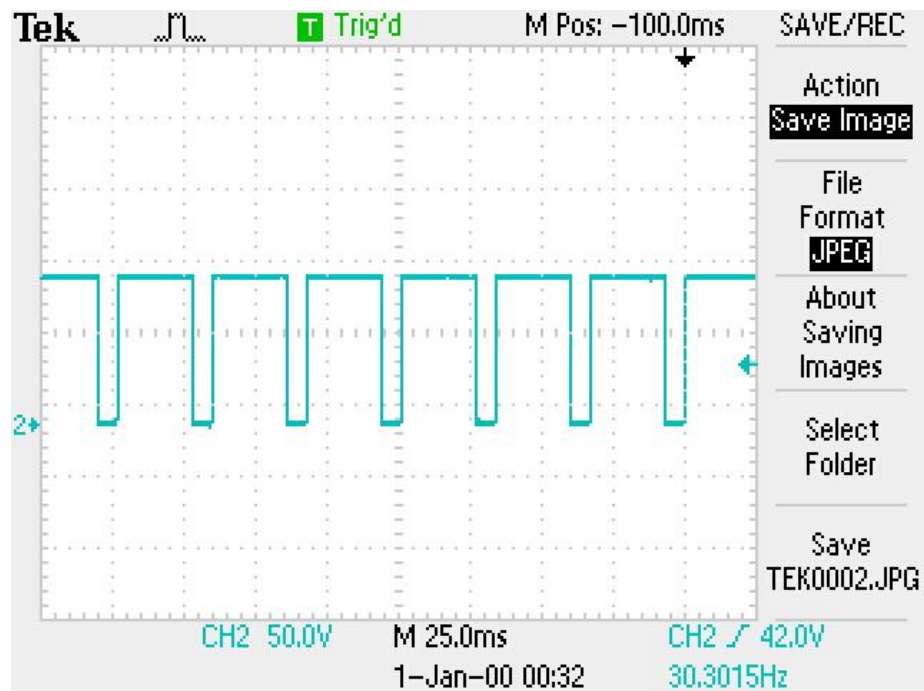

Boost WG 1 Invert ON

If the Boost WG Invert option is set to ON as shown above, the 20% duty cycle command will now result in the following output waveform:

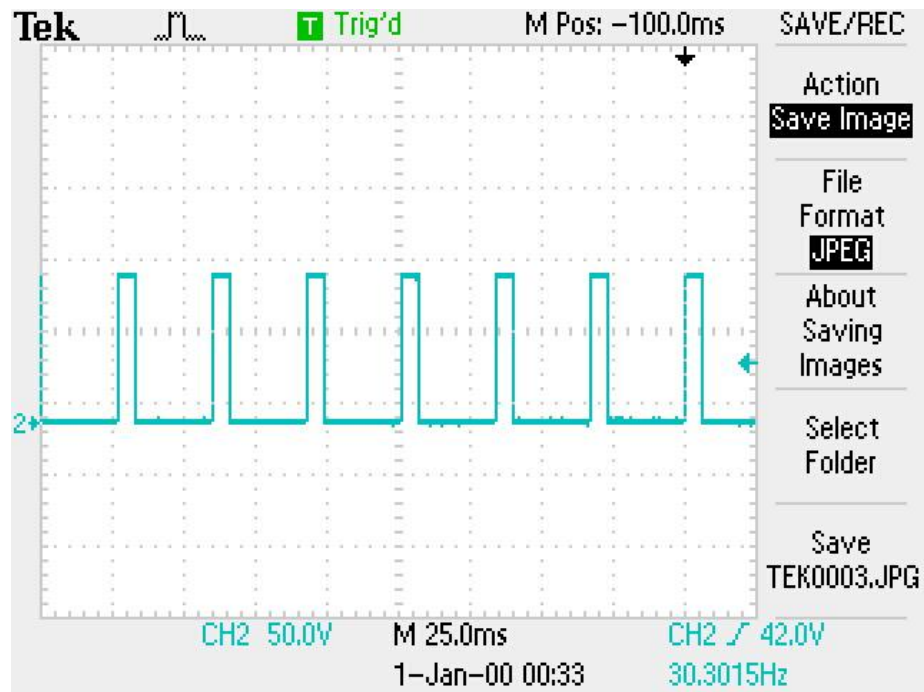

The specific wastegate type that will be used will also need to be determined when installing the boost solenoid. Illustrated below are typical ways of routing the boost (vacuum) lines with three different wastegate types.

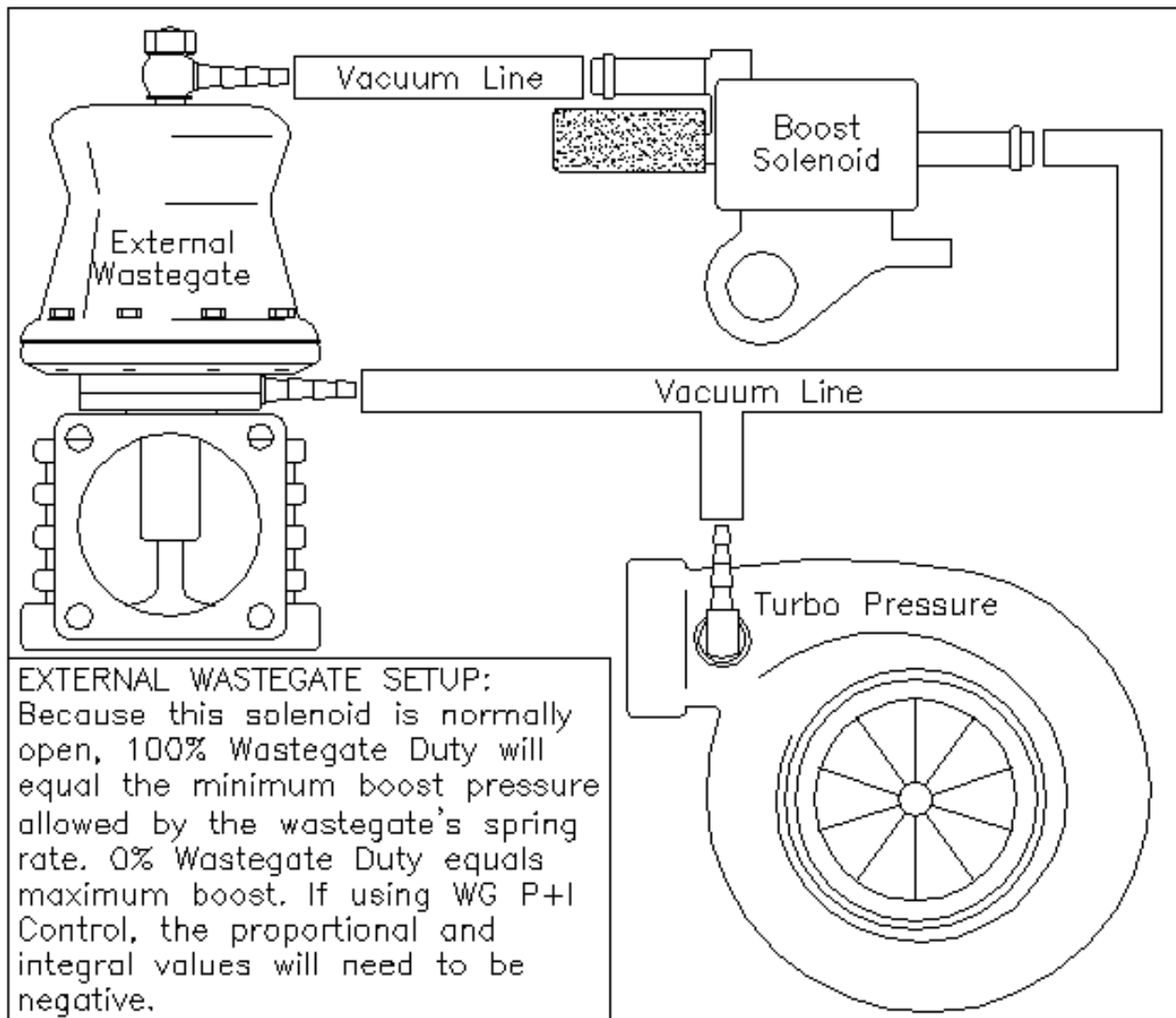

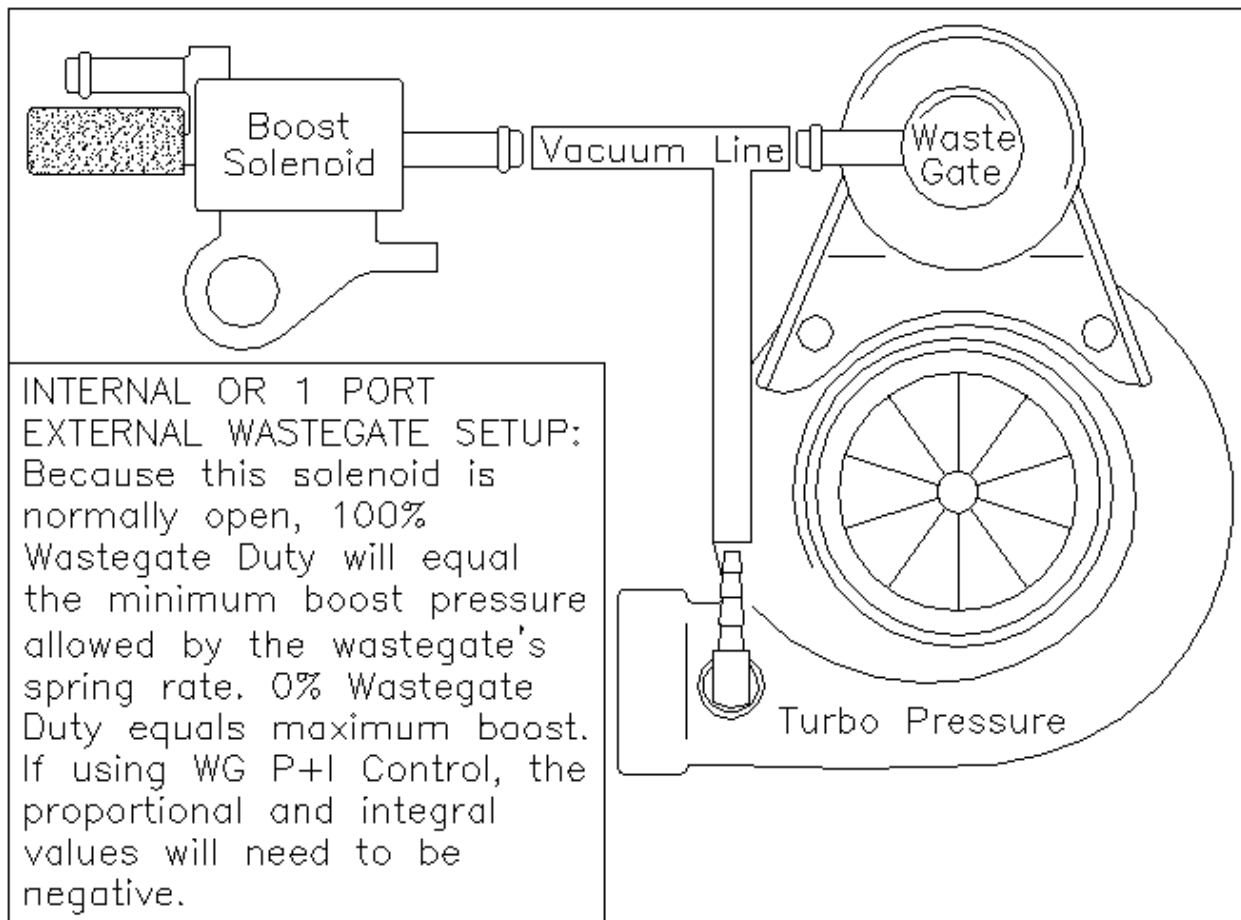

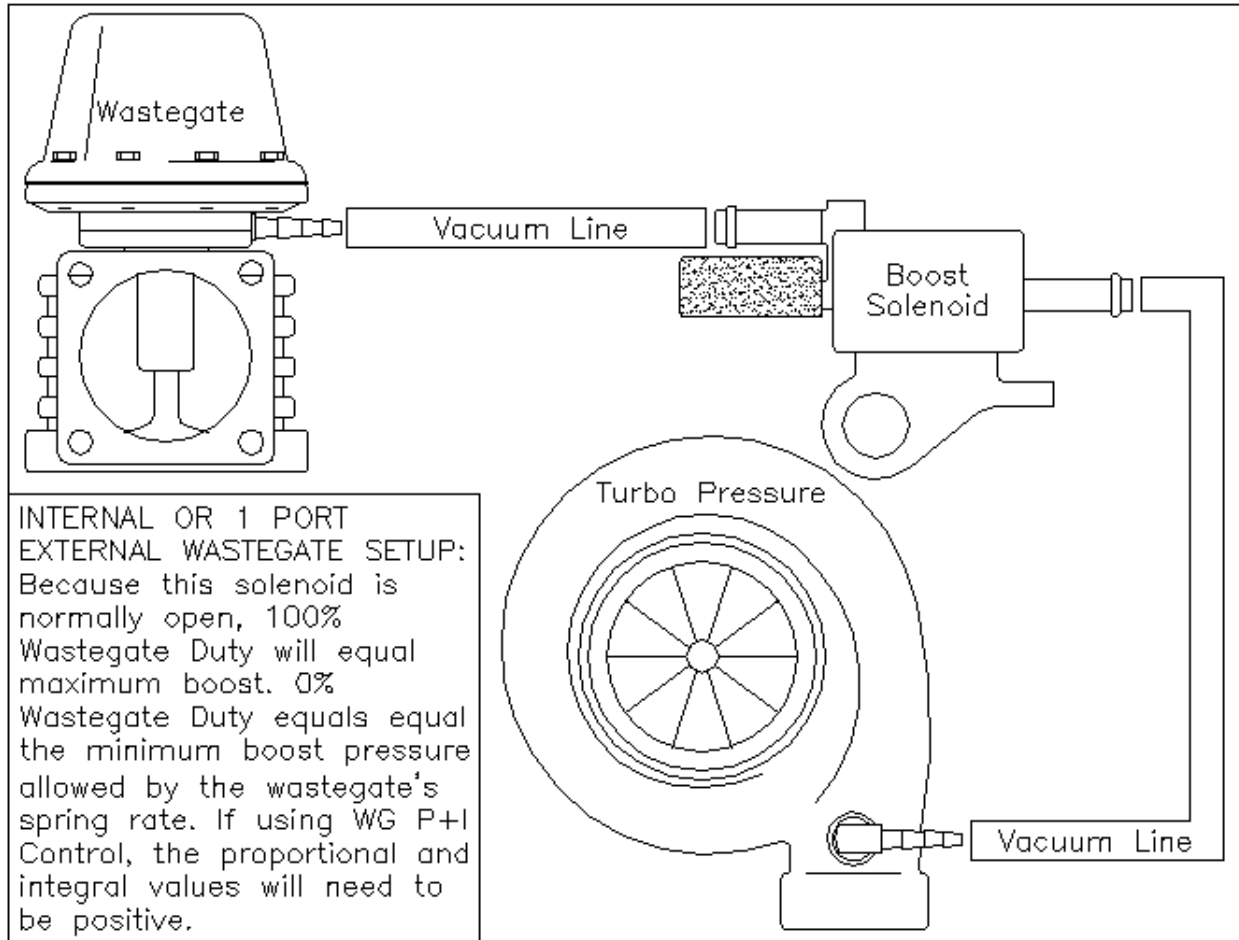

User Definable Options for Boost Control

Boost WG Duty Max

Units: % Duty Cycle

Description: Wastegate feedback maximum range. This sets the maximum allowable duty output to the boost control solenoid, preventing overdrive of the solenoid. Allows a narrow range of operation for precise boost control. Because certain solenoids will not function efficiently at specific duty cycles, manufacturers require limitations to be set.

Boost WG Duty Min

Units: % Duty Cycle

Description: Wastegate feedback minimum range. This sets the minimum allowable duty output to the boost control solenoid, preventing overdrive of the solenoid. Allows a narrow range of operation for precise boost control. Because certain solenoids will not function efficiently at specific duty cycles, manufacturers require limitations to be set.

Boost FB +Limit

Units: % Duty Cycle

Description: Sets the maximum feedback correction allowed in the positive duty direction when using P+I control only. Used to set correction limits and help stabilize boost. This function can help prevent overshooting.

Boost FB -Limit

Units: % Duty Cycle

Description: Sets the maximum feedback correction allowed in the negative duty direction when using P+I control only. Used to set correction limits and help stabilize boost. This function can help prevent overshooting.

Boost FB Int Gain

Units: Time Constant

Description: Integral control is implemented through the introduction of an integrator. Integral control is used to provide the required accuracy for the control system. This is used to fine tune the boost control at the target boost once the proportional has acted in getting close to the target. Note: start tuning the boost control feedback with this option at zero, until the proportional has the boost close to the target, then step this in slowly until the target boost is achieved. This value should be a negative value.

Boost FB Pro Gain

Units: Gain Multiplier

Description: Proportional control is a pure gain adjustment acting on the error signal to provide the driving input. It is used to adjust the speed of the system and reach the target boost quickly. The advantage of a proportional-only control is its simplicity. If boost offsets can be tolerated, the use of a proportional controller may be optimal. However, it will not eliminate the steady-state error that occurs after a set-point change or a sustained load disturbance. Note: When tuning the boost control and overshoot occurs, lower this value. If undershooting the target boost, raise this value. This value should be a negative value. When the **Boost FB On Error Control** is OFF and the **Boost Error Duty table** is not used, proportional and integral control is applicable.

Boost Switch Input

Units: Switch Input

Description: Optional alternative boost level controlled from a switch input. The new target should be set in the **Boost Switch Target** option. Used to enable both high and low boost settings via a flip of a switch.

Boost Switch Target

Units: Engine Load

Description: This new boost target activates when using the **Boost Switch Input** option. Used to enable both high and low boost settings via a flip of a switch.

Boost W/G Frequency

Units: Hz

Description: Specific frequency for the pulsewidth boost solenoid. If the boost solenoid is excessively noisy and/or slow to respond, the frequency should be changed. Note: Most boost solenoids make some noise.

Boost WG Invert

Units: On/Off

Description: Inverts the output signal. This option is based on tuner preference. Generally used when the wastgate type or solenoid is wired in such a way that low duty cycles equate to high boost and high duty cycles equate to low boost. When ON, this algorithm will be opposite.

Boost WG Output 1

Description: Defines the output pin to be used for the boost control function.

Fuel Cut Load

Units: Engine Load

Description: Boost fuel cut that when over the engine load specified, 100% fuel is cut. To keep the engine from overboosting.

Boost Control Advanced Setup Example

1. It is recommended that the engine be tuned at the lowest boost level allowed by the wastegate spring before attempting to adjust boost control settings. Disable boost feedback (set Boost FB + Limit, Boost FB – Limit, Boost FB Pro Gain, and Boost FB Int Gain to zero). Set the entire Boost WG Base Duty map to zero, and set the entire Boost Target Comp table to zero.

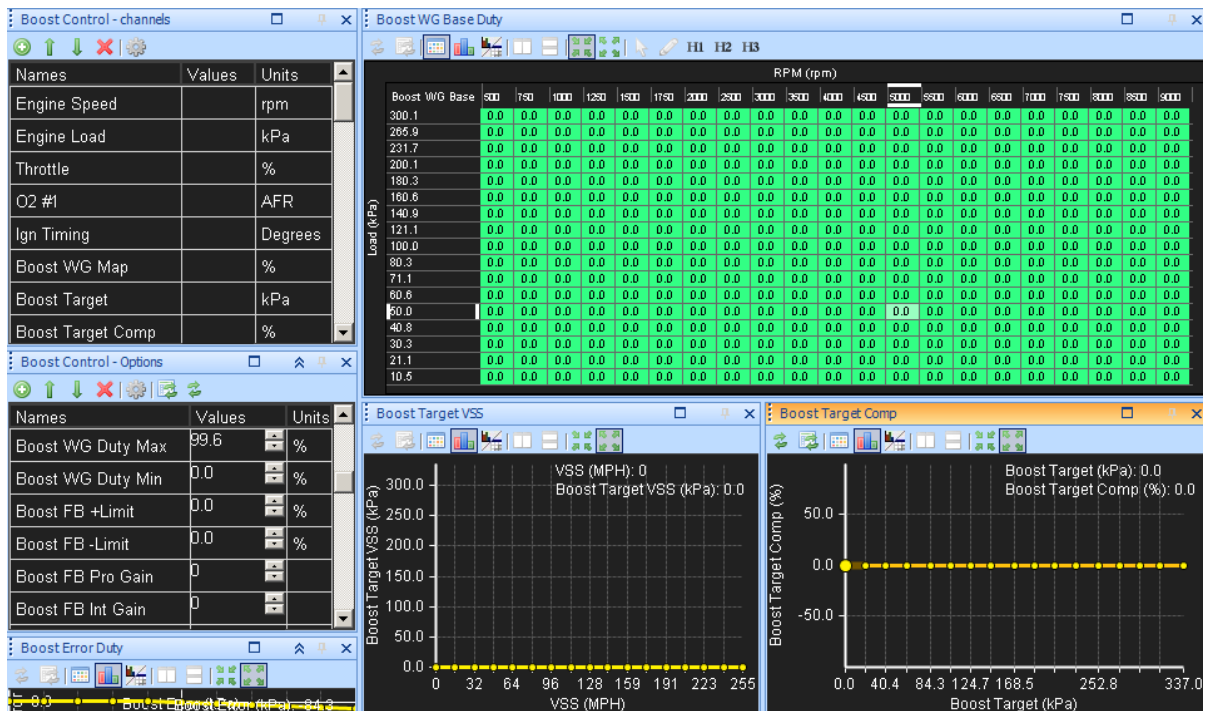

2. Set the entire Boost WG Base Duty map to 10%, perform a power pull and observe the maximum boost level that results from 10% duty cycle with your wastegate solenoid.

Repeat for other duty cycles, for instance 15%, 20%, 25%, 30%, etc... until you have reached all possible boost levels you wish to run. Save datalogs of relevant data (Boost WG 1 output, Engine Load, Throttle, Gear, Engine Speed) and/or write down the maximum boost level achieved using each duty cycle (see example below).

Boost solenoid Duty cycle (changed before each run)	Max boost (measured during run)
10	150kPa
15	155kPa
20	160kPa
25	170kPa
30	180kPa
35s	190kPa
40	200kPa
45	210kPa
50	220kPa
55	230kPa
60	240kPa
65	250kPa
70	270kPa
75	275kPa
80	280kPa

- Using the data gathered in step 2, enter the duty cycle info into the Boost Target Comp table. This table allows the EMS to use the correct duty cycle for various Boost Target levels. Set the entire WG Base Duty map to zero. In the example below, the EMS will use 55% duty cycle to when the desired Boost Target is 230kPa.

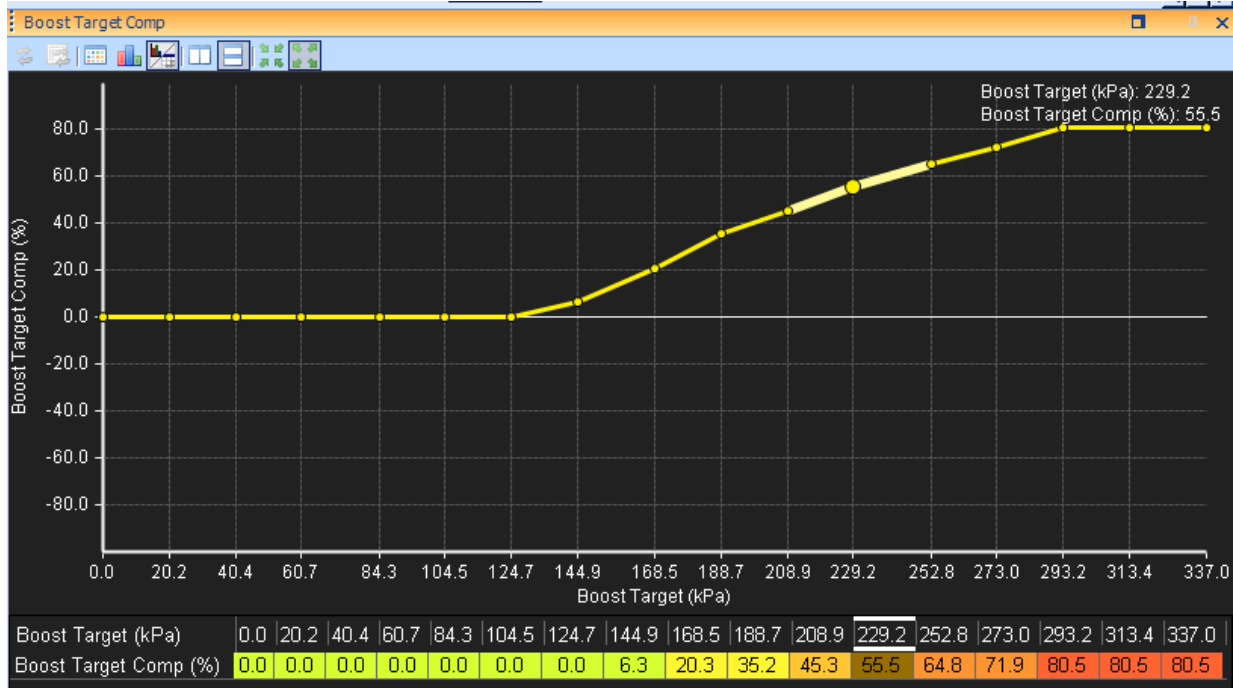

- Next, configure the Boost Target tables. There are four tables that can be used, and the values from all tables are added together at all times. The simplest method is to use only one table for adjusting the boost target, in this example the Boost Target will be 150kPa in 1st Gear, 180kPa in 2nd Gear, and 200kPa in 3rd-6th Gear. Note that all other Boost Target tables **must** be set to the minimum possible value (zero kPa in this example).

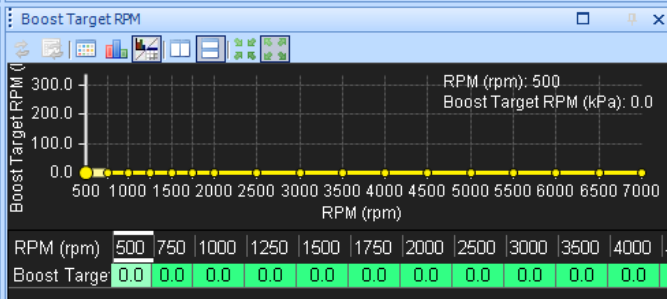
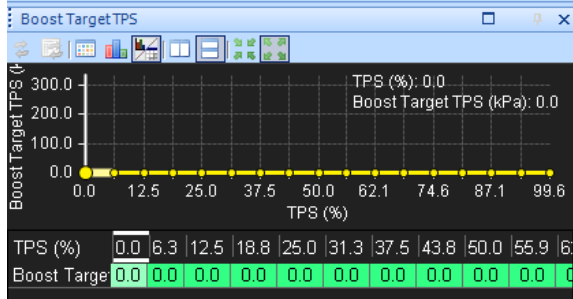
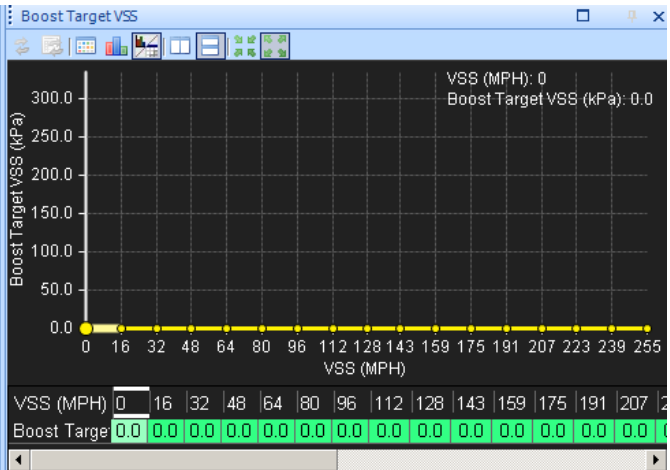
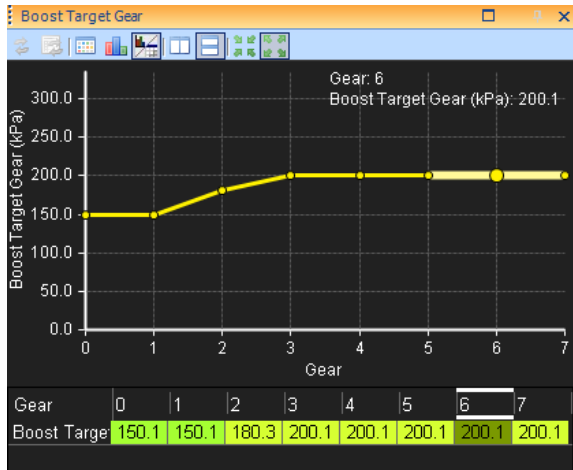

5. Here is an example of a more complex Boost Target setup. Let us assume the vehicle's aero package generates significant downforce and this provides more traction at high speed. The example below will add 10kPa to the Boost Target at 80 MPH, and 20kPa to the boost target above 100MPH. This would result in a boost target of 210kPa in 5th gear at 80 MPH and 220kPa in 5th gear at 112MPH.

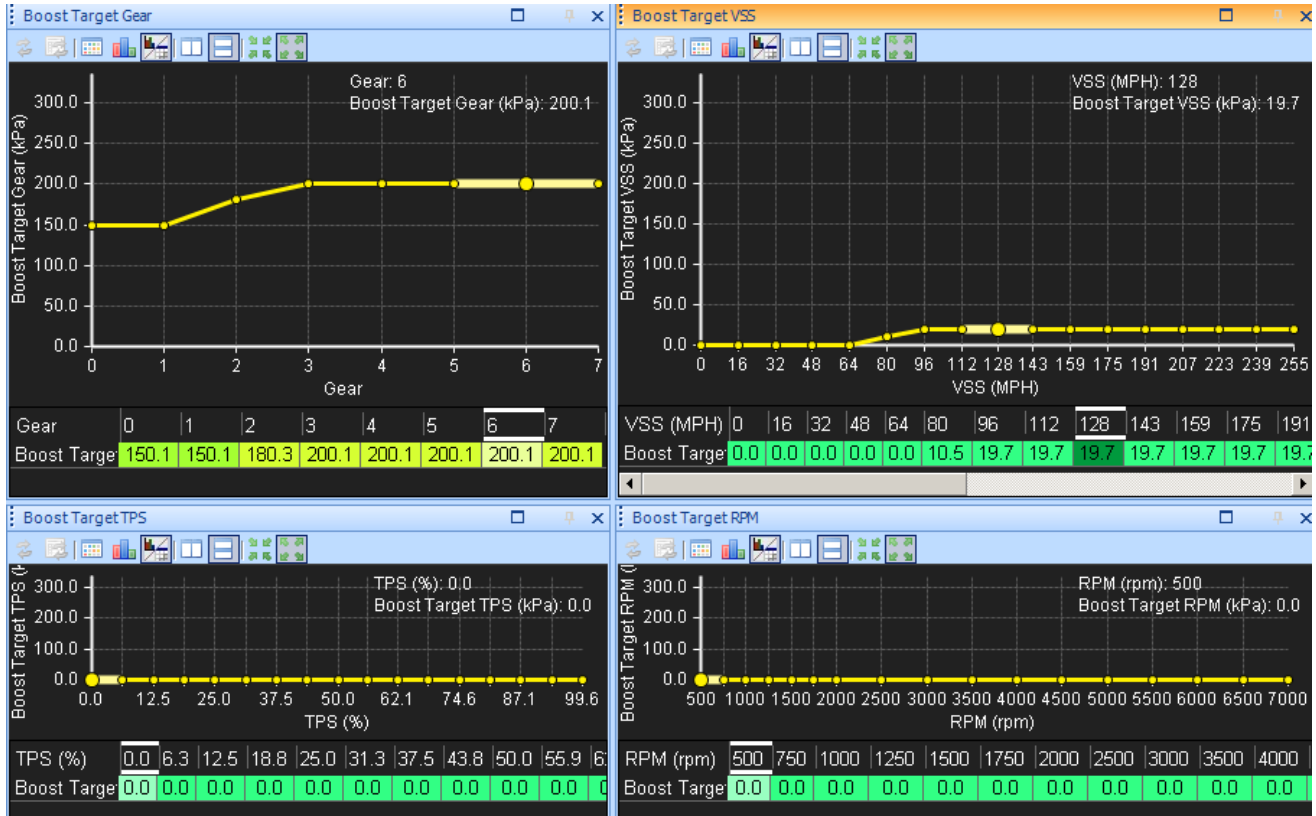

6. All 4 tables can be used in conjunction if the tuner desires. Using the Boost Target TPS table to increase boost at high throttle percentages can make the vehicle more predictable during steady-state cornering. In the example below, the vehicle has a large throttle body which does not significantly restrict airflow to the engine between 50-100% throttle. The Boost target is increased between 50-100% throttle to provide a more linear power delivery at different throttle angles.

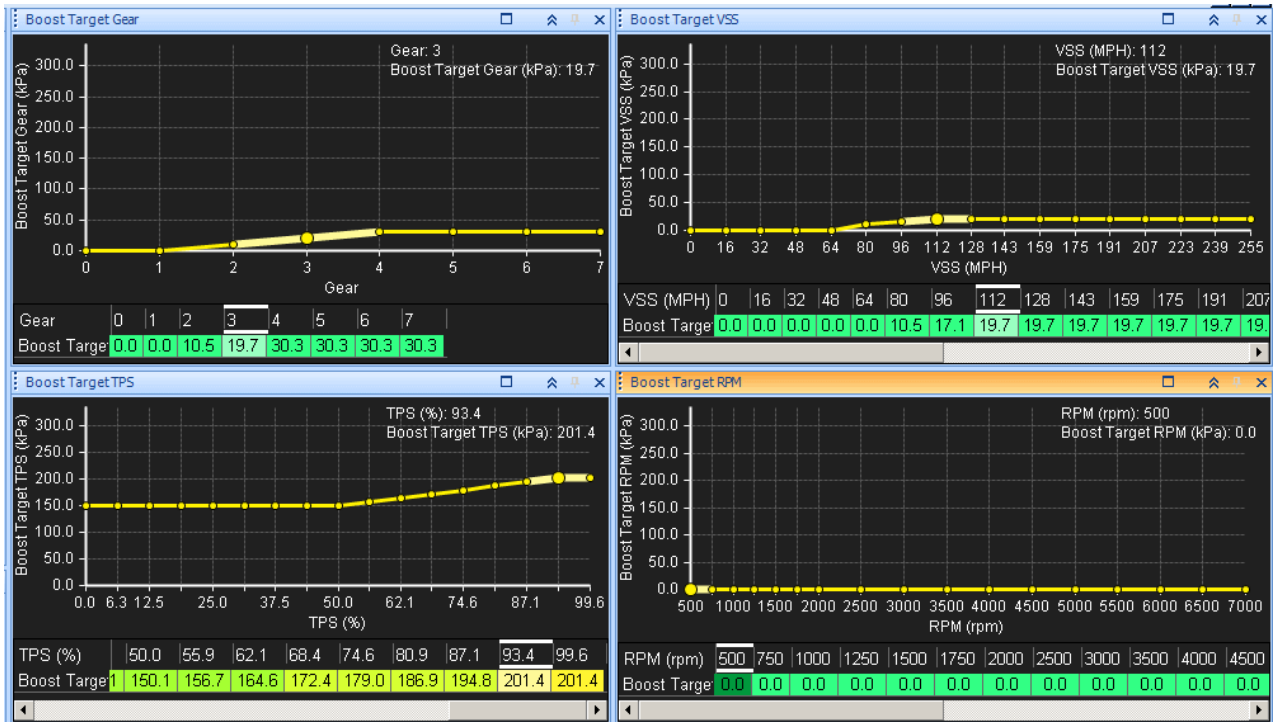

- Note that when using PSI for Load units, (-14.7) psi is the lowest possible value. Setting any table to 0psi (which is not the lowest possible value in the table) will cause that table to increase the Boost Target by 14.7 psi! The example below uses the exact same Boost Target settings but all tables are displayed in PSiG units rather than kPa.

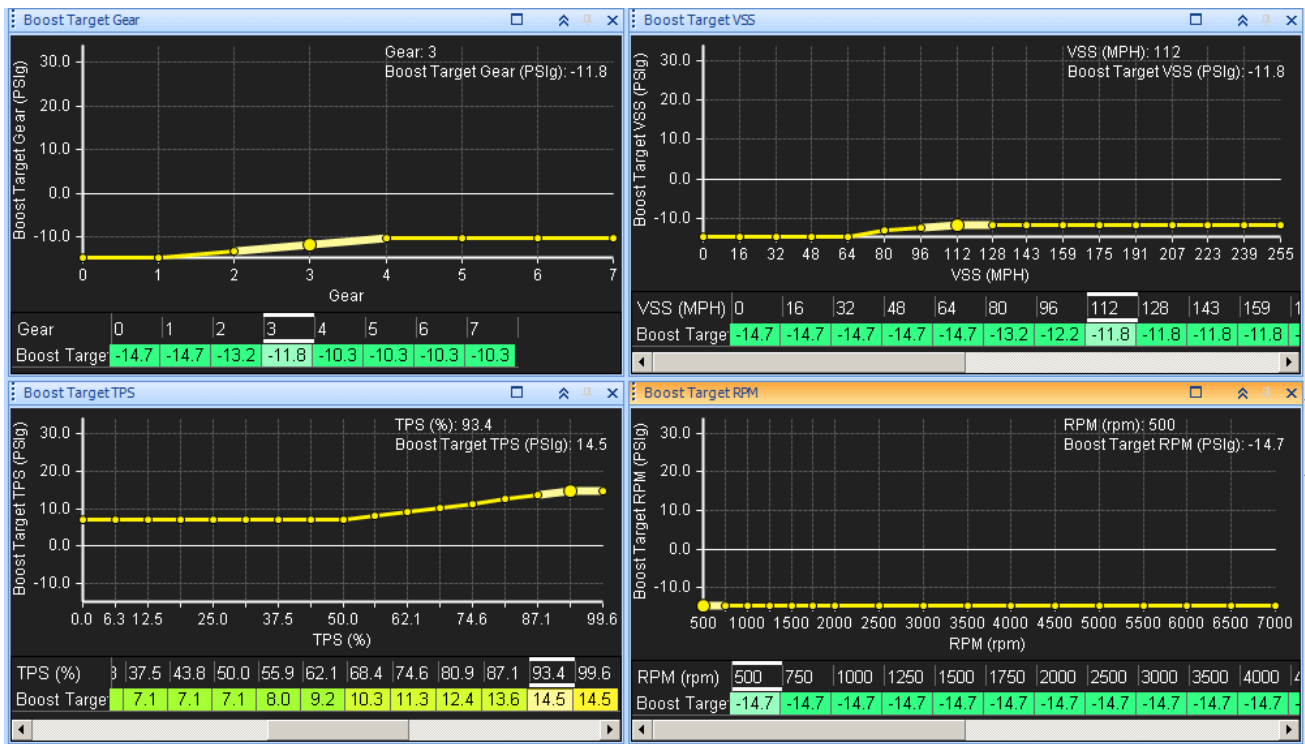

8. The Boost Error Duty table can be used for closed-loop boost feedback. If the measured Engine Load is below the desired Boost Target, the Boost Error Duty table can increase the duty cycle of the boost solenoid to reach the desired Boost Target. It is recommended to leave this table set to zero (or very small changes such as +/-1) when configuring other boost control settings.

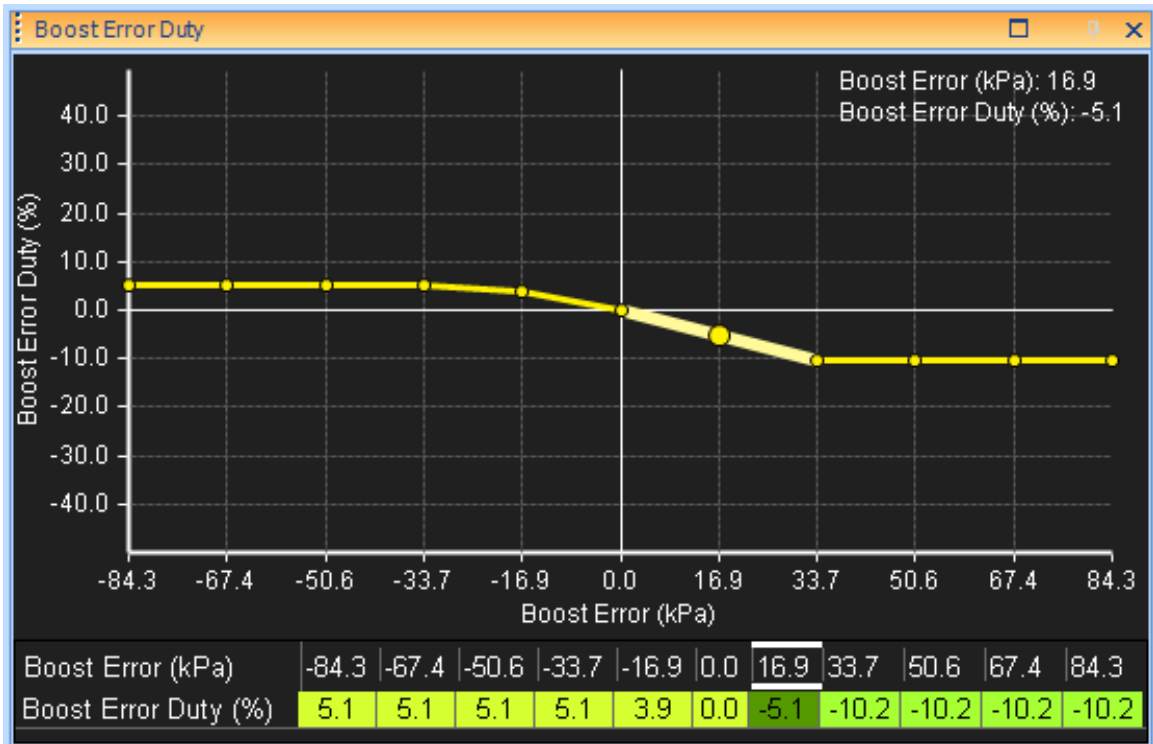

Knock Control

The **Knock Sensor Cal** table defines an RPM dependent threshold to filter out background noise. Setting up this table is key to the success of knock control. Whenever the knock sensor voltage output exceeds this table's value at the specified engine speed, it is considered to be "real knock". The difference between the actual knock signal and this threshold value determines the severity of the knock.

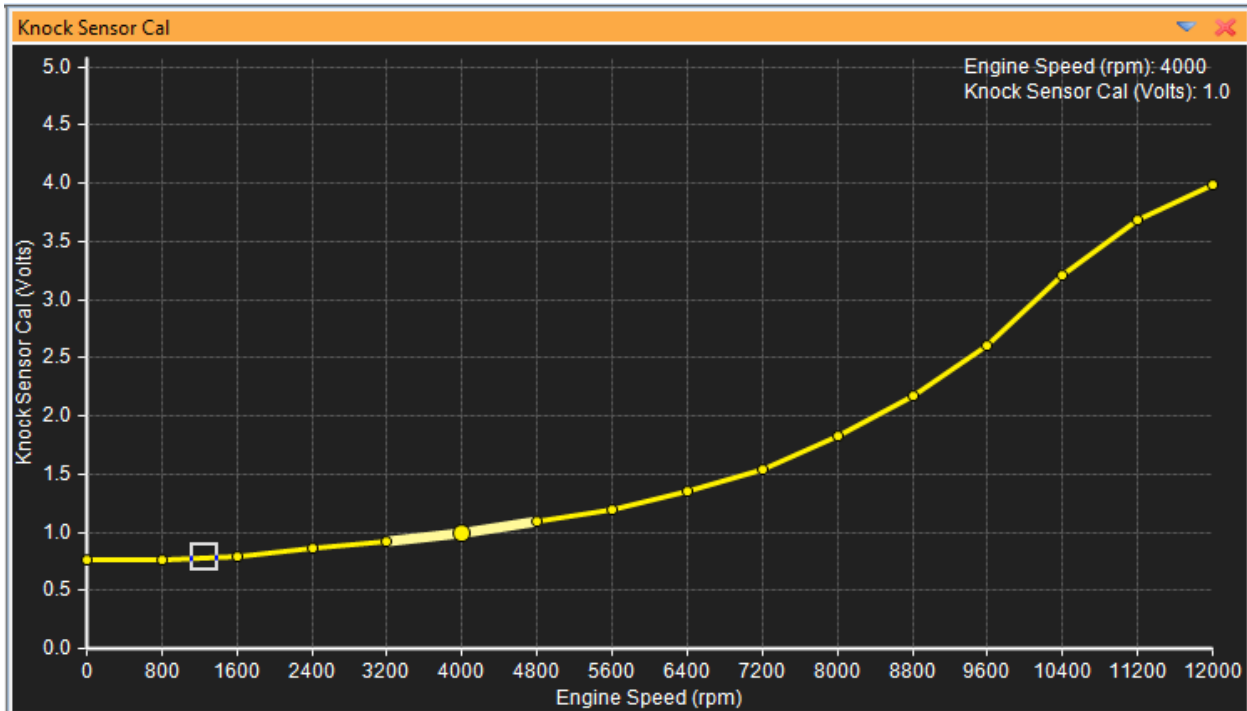

While the engine is in operation, the amount of noise from the engine will increase as RPM increases, so our job is to determine if what the EMS sees as “knock” is in fact knock. If we determine that the engine is not knocking in a certain area, we can set the filter limit (threshold) to a higher level.

There are 2 ways to use the Knock control feature on the AEM EMS. The first is passive and the second is active.

A passive system is just to monitor, but no actions are taken to correct for a knock situation. Many OEM manufacturers utilize passive knock systems.

An active system will take actions to correct for a knock situation. We can choose to correct our problem three ways:

- Add a percentage of fuel to the mixture
- Remove an amount of timing from the engine
- Add fuel and pull timing

Add Fuel due to Knock

The *Knock %Rich/Volt* will add a percentage of fuel per volt above the specified threshold.

The maximum that the EMS can add is set by *Knock Fuel Add Max*.

The EMS will return the fuel back to normal based on *Knock Decrease Fuel* and the *Knock Restore Rate*.

Remove Timing due to Knock

The *Knock Retard/Volt* value will remove your specified amount of timing per volt above the threshold.

The maximum value that the EMS can remove from the engine will be set by the *Knock Ign Rtd Max*.

The EMS will reduce the amount of spark advance based on *Knock Spark Advance* and the *Knock Restore Rate*.

In order to have both protective measures running, set both of them up in the knock options.

Knock Center Frequency

Knock center frequency is the sound that the sensor is looking to pick up. AEM suggests that this value not be changed unless you have done special testing to prove that your engine will emit a frequency other than this during an actual knock event.

Knock Gain

Knock gain is a knock signal filter. It is used to further desensitize a knock sensor. If this value gets too high, the knock sensor will not respond to knock events because the values will be filtered out.

Knock Integrator

Knock integrator is the “window” of time that engine noise is averaged. The engine noise and knock events will be averaged together in this window.

Please use caution when tuning! The idea is not to advance the timing until the engine knocks and then back the timing off a few degrees. What we want is to protect our engine from poor fuel quality or high intake temps. We need to give the engine the proper amount of timing to produce peak cylinder pressure. Advancing past this point will put you closer to the knock threshold of the engine.

Traction Control

Most OEM and available aftermarket traction control systems use the differential of a front and rear wheel speed sensor to determine traction conditions. While this is great way to control wheel slippage, it does not address all wheel drive (AWD) vehicles as all wheels spin at the same rate. AWD manufacturers do not use traction control on their vehicles as power distributing to four wheels is typically sufficient. However, AWD racing in snow, dirt, and gravel like WRC and Pike's Peak is a whole different story.

The AEM EMS traction control is the solution for all types of vehicles including 2WD and AWD. The EMS uses "acceleration" as the basis for traction control as all applications have an engine speed and vehicle speed input. And because most vehicles do not come standard with wheel speed sensors, this is the obvious choice for plug n' play traction control.

Under optimum traction conditions with no wheel slippage, the maximum rate of acceleration can be determined by:

- Engine performance
- Transmission gear ratios
- Final drive ratio
- Drive train losses
- Tire size and tread pattern
- Vehicle gross weight

If a loss of traction occurs during hard vehicle acceleration, the acceleration rate will exceed the rate possible under optimum conditions.

Theory of Operation

The EMS uses several different methods to calculate acceleration. The following are definitions for each calculation method:

A. Option **TC Timebase** OFF:

1. Option **TC Speed/Time** ON:

$$\text{Engine Accel Raw} = \frac{\Delta \text{ RPM}}{\text{Engine Rev}}$$

2. Option **TC Speed/Time** OFF:

$$\text{Engine Accel Raw} = \frac{\Delta \text{ Tooth Time}}{\text{Engine Rev}}$$

B. Option **TC Timebase ON**:

1. Option **TC Speed/Time ON**:

$$\text{Engine Accel Raw} = \frac{\Delta \text{ RPM}}{4.1 \text{ ms}}$$

2. Option **TC Speed/Time OFF**:

$$\text{Engine Accel Raw} = \frac{\Delta \text{ Tooth Time}}{4.1 \text{ ms}}$$

The parameter Engine Accel raw can be used to view or log the results from the calculation above. Once the Raw Engine Acceleration is calculated, a sensitivity factor is applied and the result is scaled versus the option TC Max. The calculation is as follows:

$$\text{Accel Rate} = \frac{(\text{Engine Accel Raw}) * (\text{TC Sensitivity Table})}{\text{TC Max}}$$

where TC Max is the maximum raw engine acceleration rate possible under optimum traction conditions.

The TC Sensitivity Table can be based on either Engine RPM or Vehicle Speed and is used to adjust the acceleration sensitivity. A value of 255 represents maximum sensitivity. Note that the viewed or logged data for Engine Acceleration is *proportional to* actual Engine Acceleration in units such as Rev/Sec². The raw data can be manipulated in many ways to achieve the required results.

Sensitivity Tables

The following is an example of how the **TC RPM Sensitivity Table** affects *Engine Acceleration Rate*:

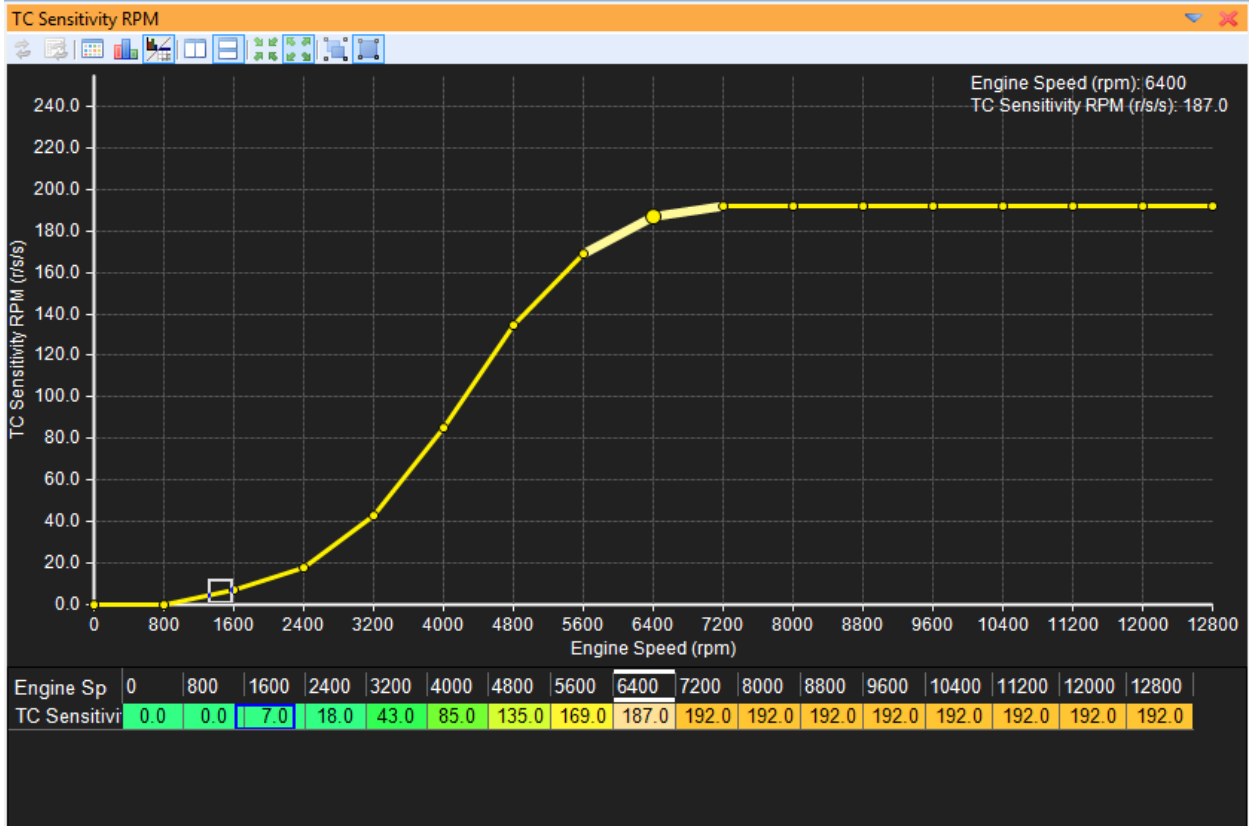

The log files below show the results. The top plot is a log of the channels **Engine RPM** and **Engine Accel Rate** and was recorded using the **TC Sensitivity RPM Table** above.

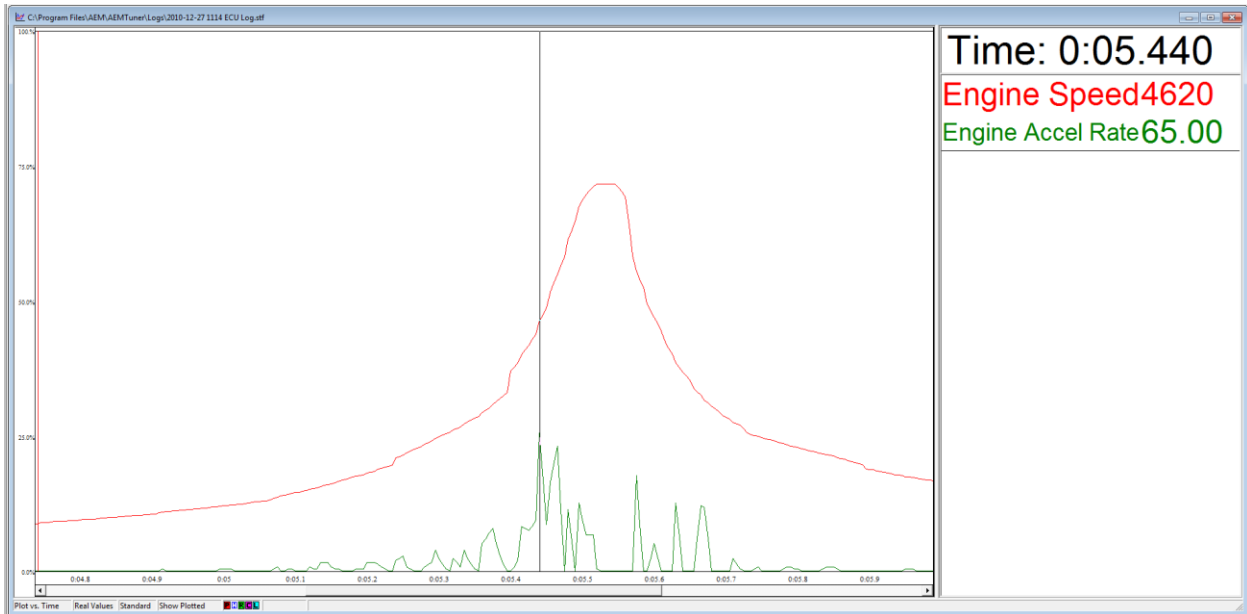

The next log shows the effect of increased sensitivity at low RPM. It was recorded using the following Sensitivity Table:

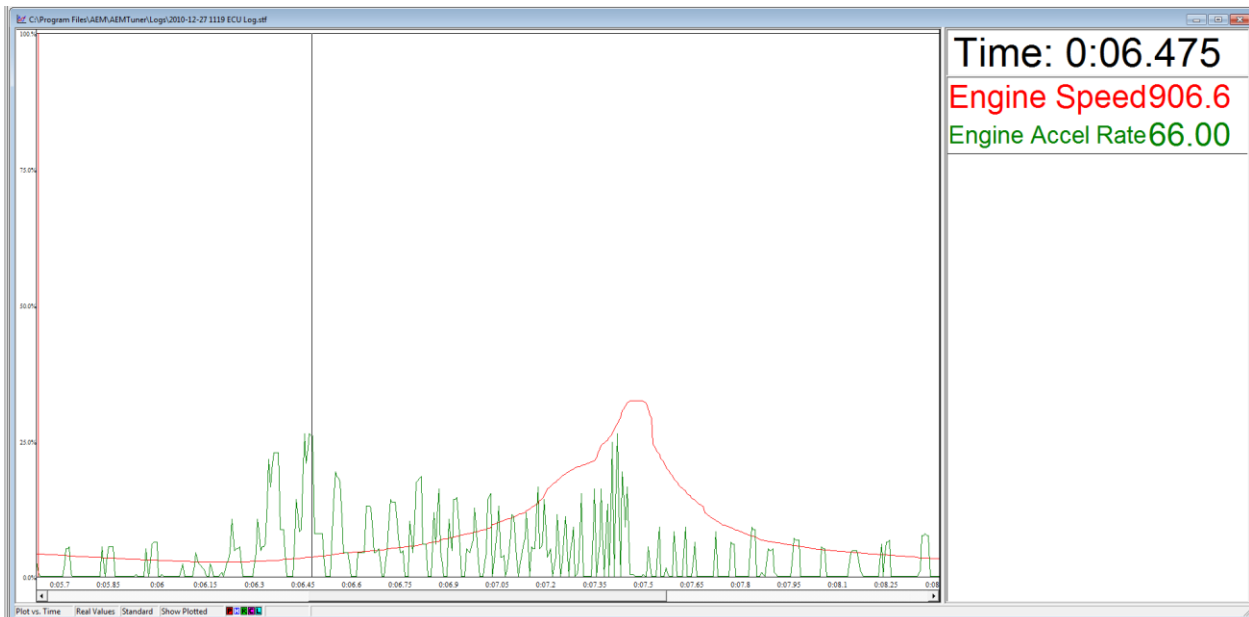
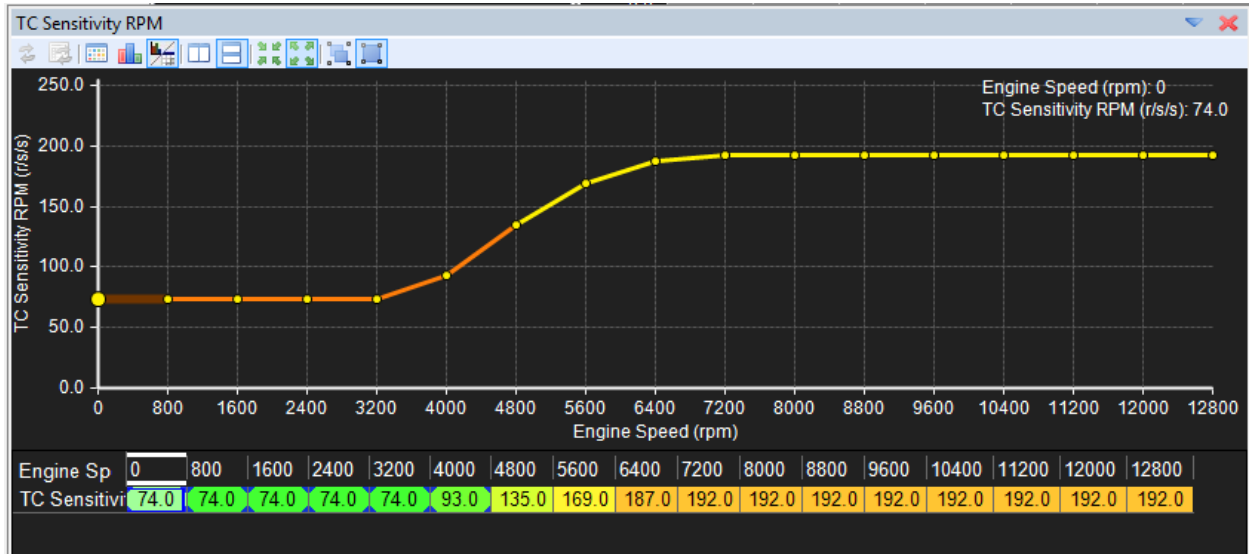

Note the increased sensitivity at low RPM in the second plot. If the **TC vs Road Speed** option is checked, the sensitivity will be based on vehicle speed. If this option is not checked, the sensitivity is based on engine RPM.

Trip Tables

With traction control enabled, the parameter Engine Accel Rate is compared to limits identified in the following tables:

- TC Ignition Retard Trip Table
- TC Ignition Cut Trip Table
- TC Fuel Cut Trip Table

The above tables are gear position sensitive and allow the user to define an Engine Acceleration Rate limit versus gear position.



The above trip table for the ignition retard function shows an increasing limit with gear position. Using the above table, a value greater than 50 for the parameter **Engine Acceleration Rate** in first gear will enable the ignition retard function. A value greater than 65 in fourth gear will enable the ignition retard function.

The trip tables for the ignition cut and fuel cut functions are set up in a similar fashion. Normally, the first line of defense for a loss of traction condition is ignition retard. If the ignition retard function is unsuccessful, an ignition/fuel cut combination can be implemented.

User Definable Traction Control Options

Traction Control

Units: On/Off Description: Enables traction control.

TC Speed/Time

Units: On/Off Description: Allows engine speed to be used for the engine acceleration rate calculation. When OFF, traction control uses tooth time for engine acceleration rate calculation.

TC vs Road Speed

Units: On/Off Description: Allows traction control to be vehicle speed dependant opposed to RPM dependent with enabling the **TC Sensitivity VSS Table**.

TC Max

Units: Accel Raw Description: Sets the maximum raw engine acceleration rate possible under optimum traction conditions

TC Ign Retard

Units: Degrees Description: Sets the amount of ignition retard used when the limit defined in the **Ignition Retard Trip Table** is exceeded.

TC Ign Cut

Units: % Description: Sets the amount of ignition cut used when the limit defined in the **Ignition Cut Trip Table** is exceeded.

TC Fuel Cut

Units: % Description: Sets the amount of fuel cut used when the limit defined in the **Fuel Cut Trip Table** is exceeded.

TC Ign Retard Resto

Units: Degrees Description: Sets the amount of ignition advance returned to the ignition timing calculation per engine revolution. This option is used to remove the ignition retard. A small number will return the timing slowly. A large number will return the timing quickly.

TC Ign Restore

Units: % Description: This option defines the amount of ignition cut % removed per engine revolution. A small number will remove the cut slowly. A large number will remove the cut quickly.

TC Fuel Restore

Units: %Description: This option defines the amount of fuel cut % removed per engine revolution. A small number will remove the cut slowly. A large number will remove the cut quickly.

TC Gear From Selecto

Units: On/Off Description: Use this option for automatic transmission applications where a variable resistance potentiometer is used to determine gear lever position.

TC Gear Ratio

Units: On/Off Description: Select this option if gear position must be determined based on the ratio of engine speed versus vehicle speed (manual transmission applications with nogear position sensor input).

TC Switch Input

Units: User Defined Switch InputDescription: Option used to define a switched input to enable traction control.

TC Adjust Input

Units: User Defined Analog Input Description: Option used to setup a 0-5V input through a potentiometer. When this input is activated, the signal will adjust the acceleration sensitivity externally. This can be used to establish different settings for varying road conditions and tire selection.

TC Min VSS

Units: Vehicle Speed Description: Traction control is disabled below the vehicle speed defined by this option.

TC Timebase

Units: On/Off Description: When ON, the engine acceleration rate is calculated using a 4.1mS time constant opposed to engine revolutions.

Traction Control Tuning Procedure

1. If the vehicle has a manual transmission with no gear position sensor, use the **Configure Gear Ratio Wizard** to setup the gear ratio table. If the vehicle has an automatic transmission with a gear position sensor, select the option **TC Gear from Sensor**.
2. AEM recommends starting with the following options settings for calculating Raw Engine Acceleration:

TC Speed/Time = ONTC Timebase = OFF

3. With the option **Traction Control** turned off, log the channels **Engine Accel raw** and **Engine Speed** under hard vehicle acceleration through each gear with optimum traction conditions.
4. Review **Engine Accel raw** to determine a maximum acceleration rate. Define this value using the option **TC Max**.
5. Use the sensitivity tables to adjust the acceleration sensitivity at varying engine or vehicle speeds. If vehicle speed is used, the option **TC vs Road Speed** must be enabled. The parameter **Engine Accel Rate** can be viewed or logged to see the results.
6. Once the sensitivity tables are defined and a good signal for **Engine Accel Rate** is established under optimum traction, define the trip tables. This should be just above the values for **Engine Accel Rate** under optimum traction conditions in each gear.
7. Start with the **TC Ign Retard** option by defining the amount of retard (20 deg is a good starting point). Define the **TC Ign Retard Resto** option (2 deg is a good starting point). These settings will retard the spark timing 20 degrees when the trip limits are exceeded and will restore the timing 2 degrees per engine revolution when the accel rate falls below the trip limits.
8. Enable traction control by selection the option **Traction Control** from the option list.
9. The settings and results can be tested under free-rev conditions by lowering the trip table limits until the traction control functions activate:

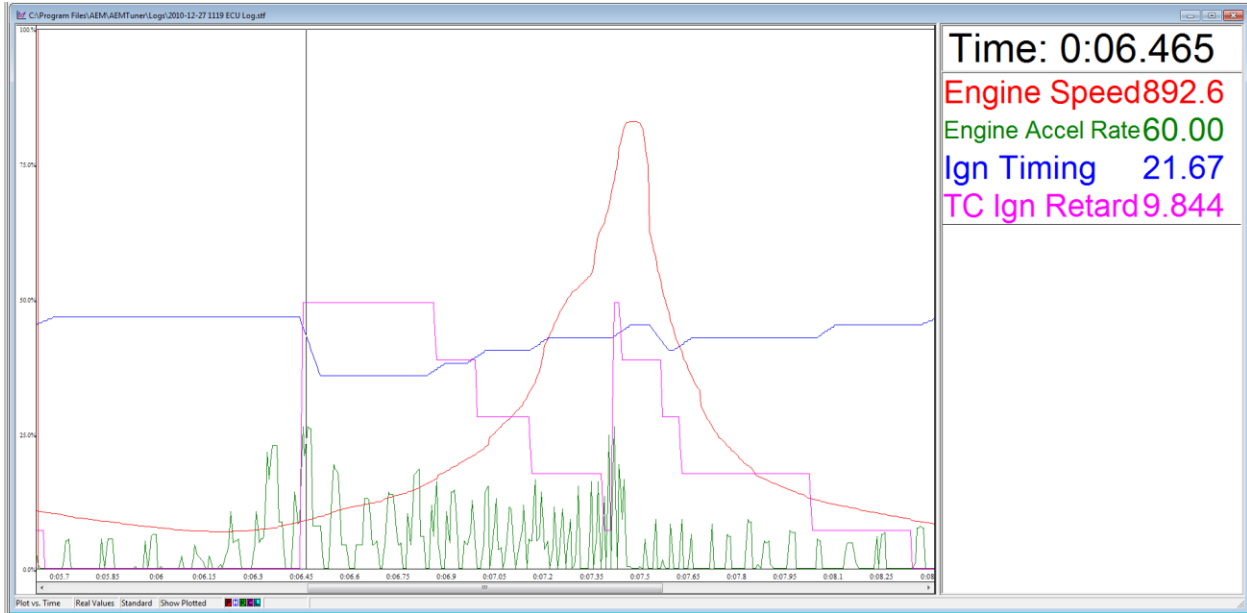

The above log shows **Engine Speed**, **Engine Accel Rate**, and **Ign Timing**. For this example, the low RPM sensitivity was set very high to illustrate the function. The ignition retard function can be clearly seen as well as the restore function.

2Step Rev Limiter

Secondary rev limiters (2 step) are most commonly used in drag racing for consistent vehicle launches. However, secondary rev limiters can also be used for full throttle shifting, anti-lag, valet parking, etc.

There are many different ways to install and program a 2Step Rev Limiter with the AEM EMS. Although any switch can be used, utilizing the factory clutch switch is most common. Most vehicles use a pull to ground switch. This simple installation involves splicing a wire from the clutch switch location to an available switch on the EMS, as shown below.

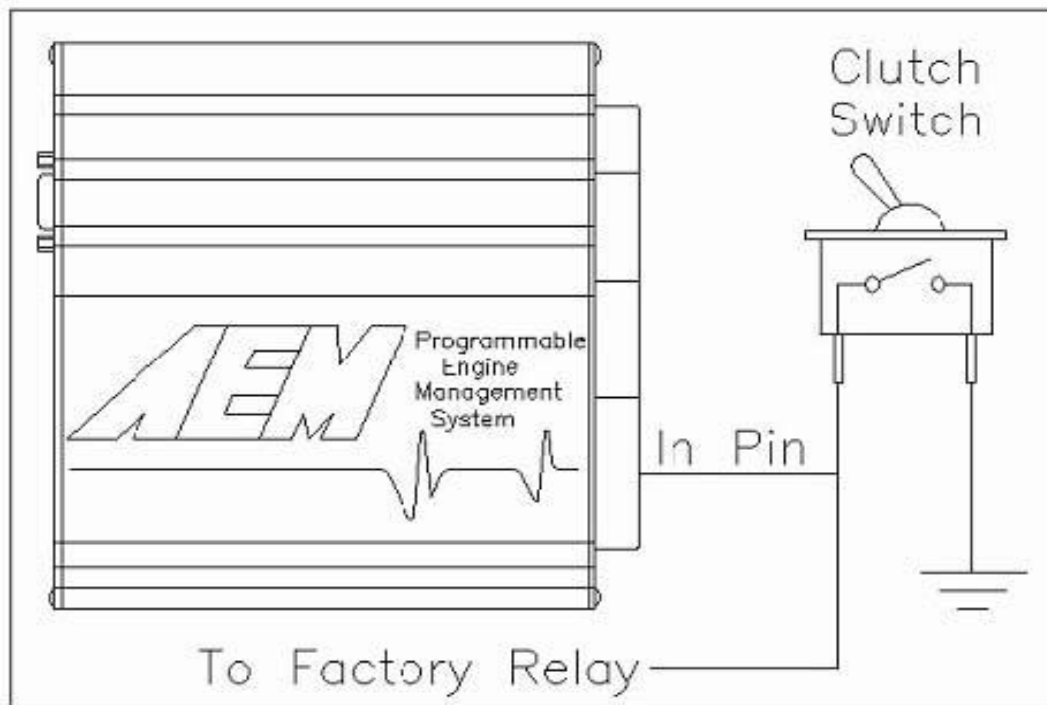

Options for the 2Step Rev Limiter

2Step Fuel Cut

Units: RPM Description: User defined RPM to enter the secondary fuel cut rev limiter. Naturally aspirated engines will use this for soft launches whereas turbocharged vehicles may not cut fuel to encourage anti-lag spool up.

2Step Ignition Cut

Units: RPM Description: User defined RPM to enter the secondary ignition cut rev limiter.

2Step Max VSS

Units: Vehicle Speed Description: Vehicle speed threshold to deactivate the 2step rev limiter. This is applied when full throttle shifting is not used. This feature helps allow automatic transmission vehicles to use the 2-step rev limiter.

2Step Input

Units: Switch Input Description: Switch input used to activate the secondary rev limiter.

2Step Retard Rev

Units: RPM Description: Target RPM point to begin ignition retard while 2Step conditions are met. The total amount of timing retard available is dependent on the ignition range. Typical range is -17 deg to +72 deg.

2Step Fuel Cut C

Units: Constant Description: Offset used for rev limit fuel duty calculation while 2Step conditions are met. $\text{Cut Duty} = \text{Cut C} + ((\text{Desired RPM Control Range}/50)) * \text{Cut M}$. The higher the value for Cut C, the more initial cut duty is applied once the RPM target is reached. Once Desired Control Range is exceeded, 100% cut duty is applied. Automatically set by rev limiter setup wizard.

2Step Fuel Cut M

Units: Multiplier Description: Multiplier used for rev limit fuel duty calculation while 2Step conditions are met. $\text{Cut Duty} = \text{Cut C} + ((\text{Desired RPM Control Range}/50)) * \text{Cut M}$. The higher the value for Cut M, the finer the control range. Once Desired Control Range is exceeded, 100% cut duty is applied. Automatically set by rev limiter setup wizard.

2Step Ign Cut C

Units: Constant Description: Offset used for rev limit ignition duty calculation while 2Step conditions are met. $\text{Cut Duty} = \text{Cut C} + ((\text{Desired RPM Control Range}/50)) * \text{Cut M}$. The higher the value for Cut C, the more initial cut duty is applied once the RPM target is reached. Once Desired Control Range is exceeded, 100% cut duty is applied. Automatically set by rev limiter setup wizard.

2Step Ign Cut M

Units: Multiplier Description: Multiplier used for rev limit ignition duty calculation while 2Step conditions are met. $\text{Cut Duty} = \text{Cut C} + ((\text{Desired RPM Control Range}/50)) * \text{Cut M}$. The higher the value for Cut M, the finer the control range. Once Desired Control Range is

exceeded, 100% cut duty is applied. Automatically set by rev limiter setup wizard.

2Step Retard C

Units: Constant Description: Offset used for ignition timing retard calculation while 2Step conditions are met. $\text{Cut Duty} = \text{Cut C} + ((\text{Desired RPM Control Range}/50)) * \text{Cut M}$. The higher the value for Cut C, the more ignition retard is applied once the RPM target is reached. Once Desired Control Range is exceeded, maximum ignition retard is applied. Maximum timing retard depends on ignition range. Typical range is -17 degrees to +72 degrees. Automatically set by rev limiter setup wizard.

2Step Retard M

Units: Multiplier Description: Multiplier used for ignition timing retard calculation while 2Step conditions are met. $\text{Cut Duty} = \text{Cut C} + ((\text{Desired RPM Control Range}/50)) * \text{Cut M}$. The higher the value for Cut M, the finer the control range. Once Desired Control Range is exceeded, maximum ignition retard is applied. Maximum timing retard depends on ignition range. Typical range is -17 degrees to +72 degrees. Automatically set by rev limiter setup wizard.

O2 Feedback

To control the engine's fuel delivery system, the EMS can be programmed to run open loop and/or closed loop O2 feedback. Closed loop uses feedback from the oxygen sensor to make temporary, but immediate, corrections to the injection to maintain a target AFR. The type of an O2 sensor will determine how O2 feedback can be controlled. Due to the nature of standard narrow band O2 sensors, 14.7:1 is the only air fuel ratio that can be accurately maintained in closed loop. However, wideband O2 sensors can be used in almost every feedback condition.

A note on AFR data

14.7:1 is the ideal AFR right?

Not necessarily. 14.7:1 is what's called the stoichiometric AFR for gasoline. It is the ratio where all available fuel is burned completely. For most performance applications, it is not the ideal AFR to operate the engine at all the time nor is it the AFR that creates the most power or even economy under all conditions.

When the fuel system is open loop, the O2 sensor is ignored and the injector pulse width relies on the **Fuel Map** and fuel compensators to adjust injection duration. Open loop is necessary during engine starts, when the O2 sensor has cooled below its operating temperature. It may also be necessary when coolant temperatures are low. In this state, the fuel vaporization is poor and the engine will require a richer mixture to properly operate. When under heavy load, the engine typically requires an air fuel ratio that is out of a narrow band oxygen sensor's standard range and open loop will be necessary. When the accel fuel function is triggered during hard accelerations, open loop may be necessary to help stabilize the O2 feedback. When the decel function cuts fuel completely, O2 feedback will not be necessary.

User Definable Options for O2 Feedback

O2 FB Rich Limit

Units: Fuel % Description: The maximum amount of fuel to add when O2 feedback is enabled.

O2 FB Coolant Min

Units: Coolant Temp Temperature Description: O2 feedback will operate when the coolant temperature has exceeded this value. This value is typically set near operating temperature.

O2 FB Global Gain

Units: Gain Multiplier Description: Overall O2 feedback gain. This value will always be one unless the proportional and integral gains are not sufficient in controlling the air fuel ratio.

O2 FB Lean Limit

Units: Fuel % Description: The maximum amount of fuel to subtract when O2 feedback is enabled.

O2 FB Max Load

Units: Engine Load Description: O2 feedback will operate when the engine load is below this value. When using a narrow band O2 sensor, O2 feedback is typically not used at high engine

loads because of the sensor's inaccuracy outside the stoichiometric range and at high exhaust gas temperatures. However, O2 feedback can be used at high engine loads with a quality UEGO sensor.

O2 FB Rate

Units: mS Description: O2 feedback base timer for both proportional and integral terms. This is how often the air fuel ratio is referenced to determine the necessary correction. A smaller number gives a faster response by effectively increasing the gain. This should be the same as the sampling rate of the O2 sensor being used. A typical value is 65.59 mS.

O2 FB Max RPM

Units: RPM Description: O2 feedback will operate when the RPM is below this value but is not in cranking mode. Limits O2 feedback control above the user-defined rpm.

O2 FB Control

Units: On/Off Description: Enables closed loop O2 feedback and the **O2 Target** parameter. After the **Fuel Map** has been tuned, O2 feedback can be enabled for automatic tuning adjustments.

O2 FB Accel Inhibit

Units: microseconds Description: O2 feedback threshold for accel fuel. O2 feedback will operate when the current **Fuel Trim (Accel)** amount is below this value. Because the acceleration fuel delivers an abundance of fuel in a very short amount of time, O2 feedback can ignore it to avoid possible air fuel ratio overshooting. However, using this function can still allow O2 feedback when there is a very small amount of acceleration fuel employed.

O2 FB Update Rate

Units: mS Description: O2 feedback delay after the acceleration fuel has been disabled. This function allows the mixture to be restored without using O2 feedback in order to prevent air fuel ratio overshooting. A typical value is 196 mS.

O2 FB Decel Inhibit

Units: mS Description: O2 feedback delay after the decel fuel function has been disabled. Typical Use: This function allows the mixture to be restored without using O2 feedback in order to prevent air fuel ratio overshooting. A typical value is 196 mS.

O2 FB Accel Clear

Units: On/Off Description: Sets O2 feedback to zero after both accel and decel fuel functions have been implemented. After utilizing accel/decel fuel, the next condition will typically be different from before. This function is used to allow the O2 feedback to clear its memory and start from zero again.

O2 FB DFCO Clear

Units: On/Off Description: Sets O2 feedback to zero after decel cut fuel have been implemented. After utilizing decel cut fuel, the next condition will typically be different from before. This function is used to allow the O2 feedback to clear its memory and start from zero again.

O2 FB Over Clear

Units: On/Off Description: Sets O2 feedback to zero when outside the load, coolant, or engine speed thresholds. After these parameters are met, the next condition will typically be different from before. This function is used to allow the O2 feedback to clear its memory and start from zero again.

2-D Tables for O2 Feedback

O2 FB Time vs Temp Table

Units: Time After Start Time vs. Coolant Temperature, Description: This table disables the O2 feedback for a set amount of time to allow arich engine start and allow time for the O2 heater to warm up.

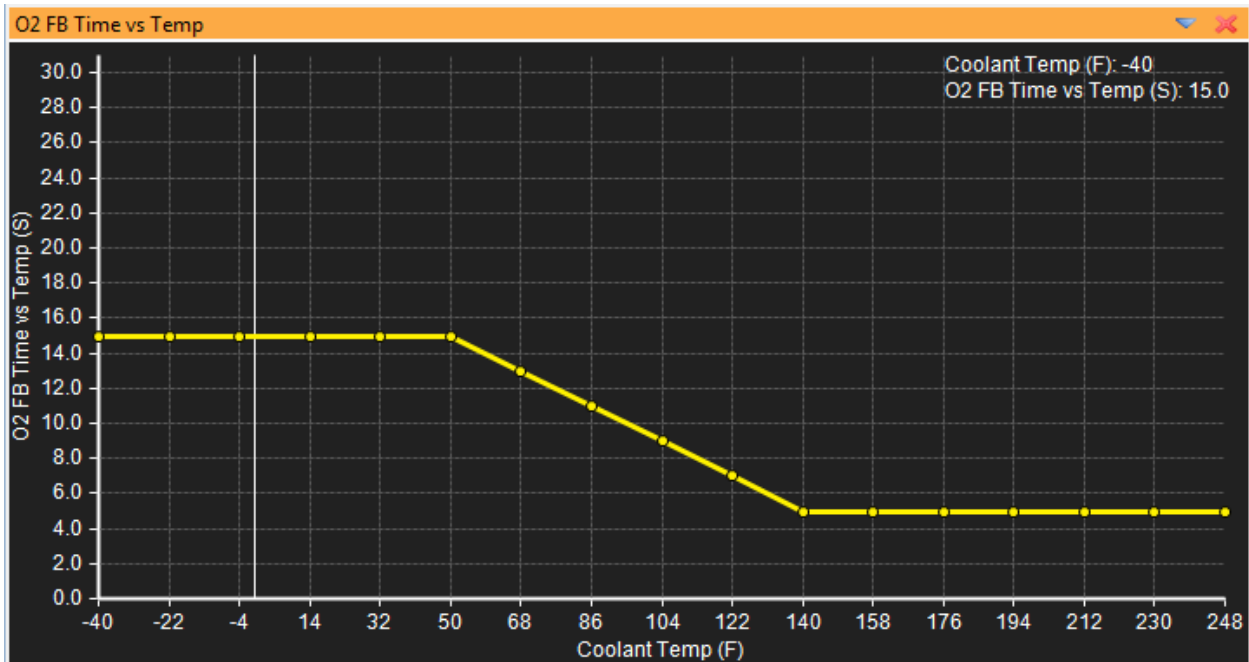

O2 FB Pro Gain table

Units: Proportional Gain vs. RPM Description: Proportional control is a pure gain adjustment acting on the error signal to provide the driving input. The advantage of a proportional-only control is its simplicity. If AFR offsets can be tolerated, the use of a proportional controller may be optimal. However, it will not eliminate the steady-state error that occurs after a set-point change or a sustained AFR disturbance. Note: When tuning the O2 feedback and overshoot occurs, lower this number. If undershooting the O2 Target, raise this number. Used to adjust the speed of the system and reach the O2 Target quickly.

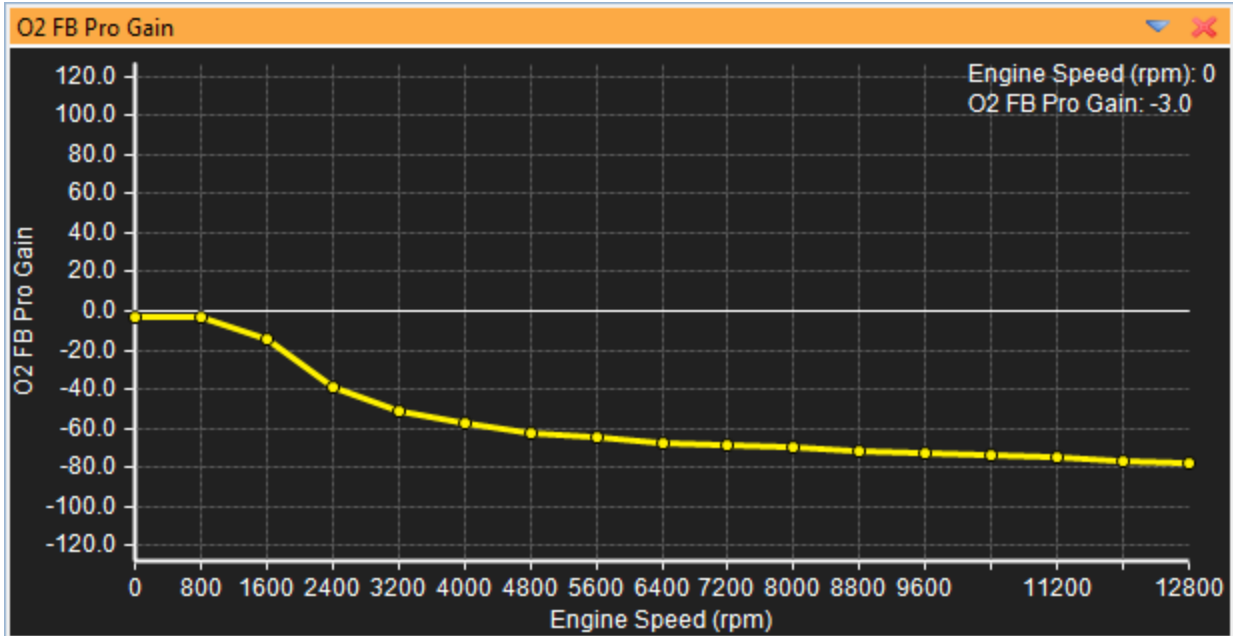

O2 FB Int Gain table

Units: Integral Gain vs. RPM Description: Integral control is implemented through the introduction of an integrator. This is used to fine tune the O2 feedback at the O2 Target once the proportional has acted in getting close to the target. Note: start tuning the O2 feedback with this option at zero, until the proportional has the feedback close to the target, then step this in slowly until the feedback holds the O2 Target. Integral control is used to provide the required accuracy for the control system.

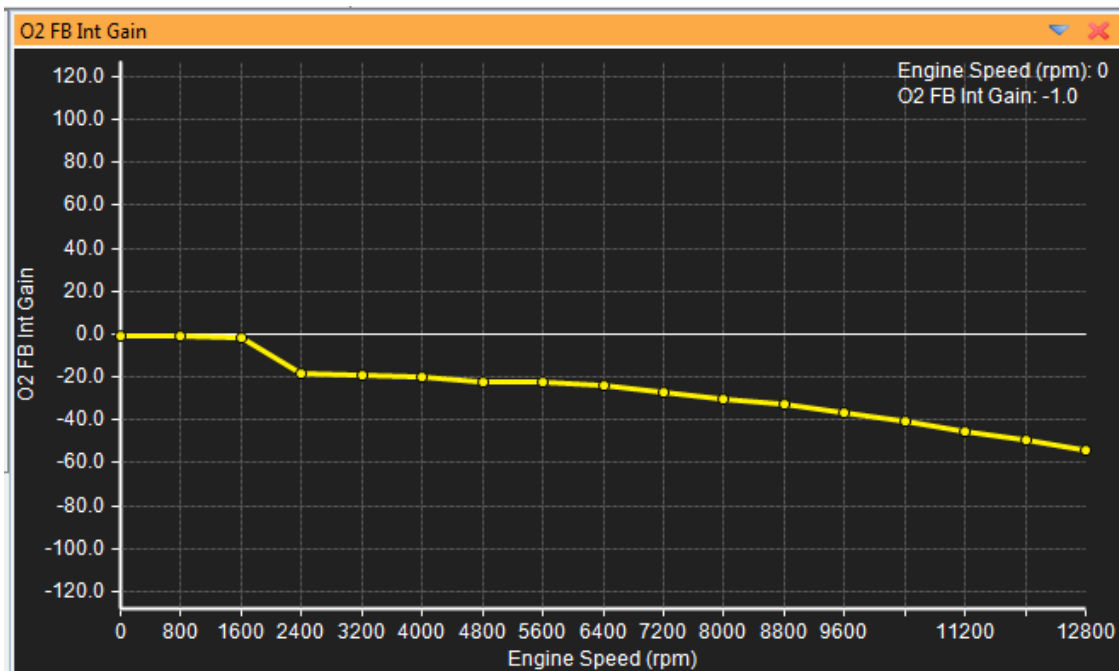

3-D Tables for O2 Feedback O2 FB

O2 FB Target

Units: Engine Load vs. RPM vs. AFR Description: O2 feedback target for specific engine loads and RPM. This map is used

O2 FB Target		RPM (rpm)																					
O2 FB Targ	500	1000	1500	2000	2500	3000	3500	3750	4000	4500	4750	5000	5500	6000	6500	7000	7500	8000	8500	9000	9500		
0.0	12.5	12.5	12.5	12.5	12.5	12.5	12.5	12.5	12.5	12.5	12.5	12.5	12.5	12.5	12.5	12.5	12.5	12.5	12.5	12.5	12.5	12.5	
-0.9	12.5	12.5	12.5	12.5	12.5	12.5	12.5	12.5	12.5	12.5	12.5	12.5	12.5	12.5	12.5	12.5	12.5	12.5	12.5	12.5	12.5	12.5	12.5
-1.8	12.5	12.5	12.5	12.5	12.5	12.5	12.5	12.5	12.5	12.5	12.5	12.5	12.5	12.5	12.5	12.5	12.5	12.5	12.5	12.5	12.5	12.5	12.5
-2.6	12.5	12.5	12.5	12.5	12.5	12.5	12.5	12.5	12.5	12.5	12.5	12.5	12.5	12.5	12.5	12.5	12.5	12.5	12.5	12.5	12.5	12.5	12.5
-3.5	13.0	13.0	13.0	13.0	13.0	13.0	13.0	13.0	13.0	13.0	13.0	13.0	13.0	13.0	13.0	13.0	13.0	13.0	13.0	13.0	13.0	13.0	13.0
-4.4	13.6	13.6	13.6	13.6	13.6	13.6	13.6	13.6	13.6	13.6	13.6	13.6	13.6	13.6	13.6	13.6	13.6	13.6	13.6	13.6	13.6	13.6	13.6
-5.3	14.2	14.2	14.2	14.2	14.2	14.2	14.2	14.2	14.2	14.2	14.2	14.2	14.2	14.2	14.2	14.2	14.2	14.2	14.2	14.2	14.2	14.2	14.2
-6.1	14.7	14.7	14.7	14.7	14.7	14.7	14.7	14.7	14.7	14.7	14.7	14.7	14.7	14.7	14.7	14.7	14.7	14.7	14.7	14.7	14.7	14.7	14.7
-6.9	14.7	14.7	14.7	14.7	14.7	14.7	14.7	14.7	14.7	14.7	14.7	14.7	14.7	14.7	14.7	14.7	14.7	14.7	14.7	14.7	14.7	14.7	14.7
-7.8	14.7	14.7	14.7	14.7	14.7	14.7	14.7	14.7	14.7	14.7	14.7	14.7	14.7	14.7	14.7	14.7	14.7	14.7	14.7	14.7	14.7	14.7	14.7
-8.7	14.7	14.7	14.7	14.7	14.7	14.7	14.7	14.7	14.7	14.7	14.7	14.7	14.7	14.7	14.7	14.7	14.7	14.7	14.7	14.7	14.7	14.7	14.7
-9.5	14.7	14.7	14.7	14.7	14.7	14.7	14.7	14.7	14.7	14.7	14.7	14.7	14.7	14.7	14.7	14.7	14.7	14.7	14.7	14.7	14.7	14.7	14.7
-10.4	14.7	14.7	14.7	14.7	14.7	14.7	14.7	14.7	14.7	14.7	14.7	14.7	14.7	14.7	14.7	14.7	14.7	14.7	14.7	14.7	14.7	14.7	14.7
-11.3	14.7	14.7	14.7	14.7	14.7	14.7	14.7	14.7	14.7	14.7	14.7	14.7	14.7	14.7	14.7	14.7	14.7	14.7	14.7	14.7	14.7	14.7	14.7
-12.2	14.7	14.7	14.7	14.7	14.7	14.7	14.7	14.7	14.7	14.7	14.7	14.7	14.7	14.7	14.7	14.7	14.7	14.7	14.7	14.7	14.7	14.7	14.7
-13.0	14.7	14.7	14.7	14.7	14.7	14.7	14.7	14.7	14.7	14.7	14.7	14.7	14.7	14.7	14.7	14.7	14.7	14.7	14.7	14.7	14.7	14.7	14.7
-13.9	14.7	14.7	14.7	14.7	14.7	14.7	14.7	14.7	14.7	14.7	14.7	14.7	14.7	14.7	14.7	14.7	14.7	14.7	14.7	14.7	14.7	14.7	14.7

Channels (can be viewed or logged)

O2 FB Delay

Units: Seconds Description: Time delay for O2 feedback operation after engine start.

O2 Target

Units: AFR Description: Air fuel ratio that directly corresponds with the AFR Map.

O2 #1

Units: AFR Description: Scaled air fuel ratio from Lambda #1.

O2 #1 Target Error

Units: AFR Description: Difference between the actual air fuel ratio and the targeted air fuel ratio from Lambda #1.

O2 #1 FB Value

Units: Fuel % Description: The current amount of fuel implemented in order to reach the air fuel ratio target.

O2 #2

Units: AFR Description: Scaled air fuel ratio from Lambda #2.

O2 #2 Target Error

Units: AFR Description: Difference between the actual air fuel ratio and the targeted air fuel ratio from Lambda #2.

O2 #2 FB Value

Units: Fuel % Description: The current amount of fuel implemented in order to reach the air fuel ratio target.

O2 FB Cleared

Units: On/Off Description: Displays if and when the O2 feedback has cleared its memory and resets back to zero when the closed loop conditions are met again.

O2 FB Frozen

Units: On/Off Description: Displays if and when the O2 feedback has saved its previous fuel correction to reinstate when the closed loop conditions are met again.

O2 FB Pro Gain

Units: Multiplier Description: Displays the current gain from the **O2 FB Pro Gain table**.

O2 FB Int Gain

Units: Multiplier Description: Displays the current gain from the **O2 FB Int Gain table**.

O2 FB Status

Units: Binary Code Description: Displays the current status of the O2 feedback function in binary

code.

Accel O2 FB Hold

Units: mS Description: The current hold time for the O2 feedback to be reinstated after the accel/decel function has been triggered.

Nitrous Control

There are several ways to control nitrous oxide with the AEM EMS. The user has complete control over all of the nitrous functions, when it activates and deactivates the solenoids, and how much fuel and timing trims are added. Below is a diagram of how AEM recommends wiring a nitrous setup.

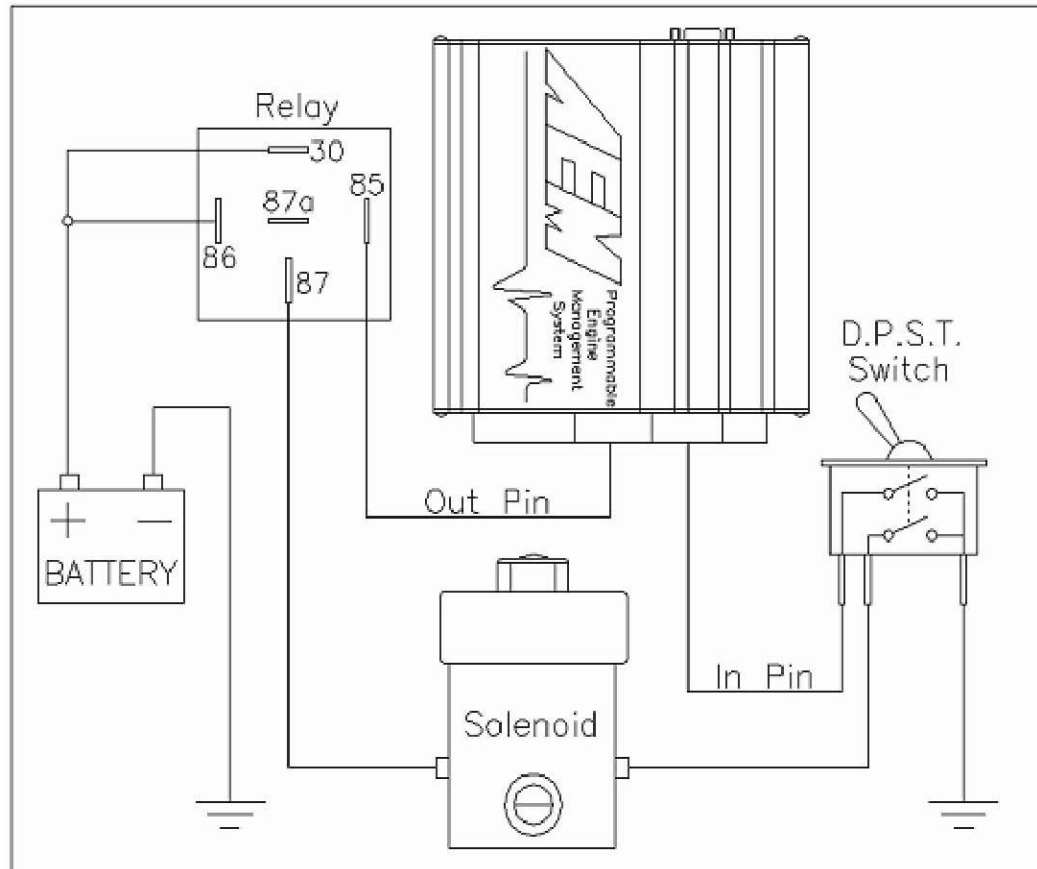

User Definable Options for Nitrous

Nitrous Control

Units: On/Off Description: This option enables the nitrous control. Set this to ON to allow the nitrous control to become active.

N2O Input

Units: Switch Input Description: This sets the input request for nitrous to become active under the set conditions.

N2O Output

Units: User Definable Output Description: This sets the output which activates the relay for the nitrous control solenoid.

N2O Off Above Load

Units: Engine Load Description: Above this engine load the EMS will deactivate the nitrous control. This can be used to spool a turbocharger, which will turn OFF the nitrous once the desired boost has been reached, or as a safety measure to prevent the nitrous from being active in an overboost situation. When the engine reaches this load point, the EMS will cut the active signal to the nitrous relay, and disable any trims that have been set. Set this to the maximum allowable pressure to be active.

N2O Reinstate Load

Units: Engine Load Description: Hysteresis condition for nitrous load conditions. Must be set higher than **N2O Off Below Load** option and lower than the **N2O Off Above Load** condition.

N2O Off Below Load

Units: Engine Load Description: The nitrous control will be OFF when below this engine load.
Note: The nitrous will not necessarily be ON when above this engine load.

N2O Overrev Off

Units: RPM Description: Nitrous will be activated only when the engine speed is below this value. This is an over-rev type function that should disable the nitrous under unsafe engine conditions or when on the rev limiter.

N2O Overrev On

Units: RPM Description: Hysteresis condition for nitrous overrev condition. Must be set lower than **N2O Overrev Off** option.

N2O On Above TPS

Units: Throttle % Description: Above this number, the nitrous will be active. Set this number just above the **N2O Off Below TPS** option.

N2O Off Below TPS

Units: Throttle % Description: Below this number, the nitrous will be active. Set this number just below the **N2O On Above TPS** option.

N2O Max VSS

Units: Vehicle Speed Description: Above this number, the nitrous will be deactivated. Set this number above the **N2O Minimum VSS** option.

N2O Min VSS

Units: Vehicle Speed Description: Below this number, the nitrous will be deactivated. Set this number below the **N2O Maximum VSS** option.

3-D Maps for Nitrous

N2O Fuel map

Units: Engine Load vs Engine Speed vs Fuel % Description: This map allows a percentage of additional fuel to be added or subtracted from the base map when the nitrous options become active. This map allows adjustment over engine speed and engine load.

N2O Fuel		RPM (rpm)																	
N2O Fuel (%)	1500	2000	2500	3000	3500	3750	4000	4500	4750	5000	5500	6000	6500	7000	7500	8000	8500	9000	9500
0.0	0.0	0.0	0.0	0.0	0.0	0.0	0.0	0.0	0.0	0.0	0.0	0.0	0.0	0.0	0.0	0.0	0.0	0.0	0.0
-0.9	0.0	0.0	0.0	0.0	0.0	0.0	0.0	0.0	0.0	0.0	0.0	0.0	0.0	0.0	0.0	0.0	0.0	0.0	0.0
-1.8	0.0	0.0	0.0	0.0	0.0	0.0	0.0	0.0	0.0	0.0	0.0	0.0	0.0	0.0	0.0	0.0	0.0	0.0	0.0
-2.6	0.0	0.0	0.0	0.0	0.0	0.0	0.0	0.0	0.0	0.0	0.0	0.0	0.0	0.0	0.0	0.0	0.0	0.0	0.0
-3.5	0.0	0.0	0.0	0.0	0.0	0.0	0.0	0.0	0.0	0.0	0.0	0.0	0.0	0.0	0.0	0.0	0.0	0.0	0.0
-4.4	0.0	0.0	0.0	0.0	0.0	0.0	0.0	0.0	0.0	0.0	0.0	0.0	0.0	0.0	0.0	0.0	0.0	0.0	0.0
-5.3	0.0	0.0	0.0	0.0	0.0	0.0	0.0	0.0	0.0	0.0	0.0	0.0	0.0	0.0	0.0	0.0	0.0	0.0	0.0
-6.1	0.0	0.0	0.0	0.0	0.0	0.0	0.0	0.0	0.0	0.0	0.0	0.0	0.0	0.0	0.0	0.0	0.0	0.0	0.0
-6.9	0.0	0.0	0.0	0.0	0.0	0.0	0.0	0.0	0.0	0.0	0.0	0.0	0.0	0.0	0.0	0.0	0.0	0.0	0.0
-7.8	0.0	0.0	0.0	0.0	0.0	0.0	0.0	0.0	0.0	0.0	0.0	0.0	0.0	0.0	0.0	0.0	0.0	0.0	0.0
-8.7	0.0	0.0	0.0	0.0	0.0	0.0	0.0	0.0	0.0	0.0	0.0	0.0	0.0	0.0	0.0	0.0	0.0	0.0	0.0
-9.5	0.0	0.0	0.0	0.0	0.0	0.0	0.0	0.0	0.0	0.0	0.0	0.0	0.0	0.0	0.0	0.0	0.0	0.0	0.0
-10.4	0.0	0.0	0.0	0.0	0.0	0.0	0.0	0.0	0.0	0.0	0.0	0.0	0.0	0.0	0.0	0.0	0.0	0.0	0.0
-11.3	0.0	0.0	0.0	0.0	0.0	0.0	0.0	0.0	0.0	0.0	0.0	0.0	0.0	0.0	0.0	0.0	0.0	0.0	0.0
-12.2	0.0	0.0	0.0	0.0	0.0	0.0	0.0	0.0	0.0	0.0	0.0	0.0	0.0	0.0	0.0	0.0	0.0	0.0	0.0
-13.0	0.0	0.0	0.0	0.0	0.0	0.0	0.0	0.0	0.0	0.0	0.0	0.0	0.0	0.0	0.0	0.0	0.0	0.0	0.0
-13.9	0.0	0.0	0.0	0.0	0.0	0.0	0.0	0.0	0.0	0.0	0.0	0.0	0.0	0.0	0.0	0.0	0.0	0.0	0.0

N2O Ignition map

Units: Engine Load vs Engine Speed vs Degrees Description: This map allows ignition timing to be advanced or retarded against the base ignition map when the nitrous control is active. This map is adjustable over engine speed and engine load.

		RPM (rpm)																				
		500	1000	1500	2000	2500	3000	3500	3750	4000	4500	4750	5000	5500	6000	6500	7000	7500	8000	8500	9000	9500
Load (PSig)	N2O Ignitio	0.0	0.0	0.0	0.0	0.0	0.0	0.0	0.0	0.0	0.0	0.0	0.0	0.0	0.0	0.0	0.0	0.0	0.0	0.0	0.0	0.0
	-0.9	0.0	0.0	0.0	0.0	0.0	0.0	0.0	0.0	0.0	0.0	0.0	0.0	0.0	0.0	0.0	0.0	0.0	0.0	0.0	0.0	0.0
	-1.8	0.0	0.0	0.0	0.0	0.0	0.0	0.0	0.0	0.0	0.0	0.0	0.0	0.0	0.0	0.0	0.0	0.0	0.0	0.0	0.0	0.0
	-2.6	0.0	0.0	0.0	0.0	0.0	0.0	0.0	0.0	0.0	0.0	0.0	0.0	0.0	0.0	0.0	0.0	0.0	0.0	0.0	0.0	0.0
	-3.5	0.0	0.0	0.0	0.0	0.0	0.0	0.0	0.0	0.0	0.0	0.0	0.0	0.0	0.0	0.0	0.0	0.0	0.0	0.0	0.0	0.0
	-4.4	0.0	0.0	0.0	0.0	0.0	0.0	0.0	0.0	0.0	0.0	0.0	0.0	0.0	0.0	0.0	0.0	0.0	0.0	0.0	0.0	0.0
	-5.3	0.0	0.0	0.0	0.0	0.0	0.0	0.0	0.0	0.0	0.0	0.0	0.0	0.0	0.0	0.0	0.0	0.0	0.0	0.0	0.0	0.0
	-6.1	0.0	0.0	0.0	0.0	0.0	0.0	0.0	0.0	0.0	0.0	0.0	0.0	0.0	0.0	0.0	0.0	0.0	0.0	0.0	0.0	0.0
	-6.9	0.0	0.0	0.0	0.0	0.0	0.0	0.0	0.0	0.0	0.0	0.0	0.0	0.0	0.0	0.0	0.0	0.0	0.0	0.0	0.0	0.0
	-7.8	0.0	0.0	0.0	0.0	0.0	0.0	0.0	0.0	0.0	0.0	0.0	0.0	0.0	0.0	0.0	0.0	0.0	0.0	0.0	0.0	0.0
	-8.7	0.0	0.0	0.0	0.0	0.0	0.0	0.0	0.0	0.0	0.0	0.0	0.0	0.0	0.0	0.0	0.0	0.0	0.0	0.0	0.0	0.0
	-9.5	0.0	0.0	0.0	0.0	0.0	0.0	0.0	0.0	0.0	0.0	0.0	0.0	0.0	0.0	0.0	0.0	0.0	0.0	0.0	0.0	0.0
	-10.4	0.0	0.0	0.0	0.0	0.0	0.0	0.0	0.0	0.0	0.0	0.0	0.0	0.0	0.0	0.0	0.0	0.0	0.0	0.0	0.0	0.0
	-11.3	0.0	0.0	0.0	0.0	0.0	0.0	0.0	0.0	0.0	0.0	0.0	0.0	0.0	0.0	0.0	0.0	0.0	0.0	0.0	0.0	0.0
	-12.2	0.0	0.0	0.0	0.0	0.0	0.0	0.0	0.0	0.0	0.0	0.0	0.0	0.0	0.0	0.0	0.0	0.0	0.0	0.0	0.0	0.0
-13.0	0.0	0.0	0.0	0.0	0.0	0.0	0.0	0.0	0.0	0.0	0.0	0.0	0.0	0.0	0.0	0.0	0.0	0.0	0.0	0.0	0.0	
-13.9	0.0	0.0	0.0	0.0	0.0	0.0	0.0	0.0	0.0	0.0	0.0	0.0	0.0	0.0	0.0	0.0	0.0	0.0	0.0	0.0	0.0	

Channels (can be viewed or logged)

Nitrous

Units: On/Off Description: Displays the current status of the nitrous function.

N2O Fuel

Units: Fuel % Description: Displays the current amount of fuel added or subtracted from the N2O Fuel map.

N2O Spark

Units: Degrees Description: Displays the current amount of ignition timing advanced or retarded from the N2O Ignition map.

Note:

All of the nitrous options must be met for the EMS to activate the selected output and add the fuel and ignition trims. If any one of the options falls out of their ON conditions, the control will be disabled.

Anti-Lag

Turbo lag is defined as the time delay before the turbocharger has produced boost pressure. Since turbochargers are designed and sized to operate at specific rpm ranges and air flow conditions, some turbo lag is inherent in the system. To fully understand turbo lag, you must first understand the operation principles behind what causes a turbo to make boost.

Boost is not made by rpm alone. There is a big difference in the airflow through an engine at 6,000 rpm in neutral, 6,000 rpm in first gear at part throttle, and 6,000 rpm in high gear at full throttle. Turbochargers are even more affected by these airflow differences and especially load differences than most other devices. This is why you may be able to see a small amount of boost with a positive displacement supercharger at WOT in neutral, but you will most likely not even see any boost at WOT in neutral with a turbocharger.

A given turbocharged vehicle may produce full boost in first gear by 3,500 rpm. This same vehicle may produce full boost in 4th gear by 2,300 rpm. The same vehicle, when pulling a heavy trailer, may produce full boost by 1,800 rpm even in 1st gear. These conditions are more specific to manual transmission vehicles as the boost has to build in each gear after the throttle is closed during the shift. Automatic transmission vehicles operate differently as they can be "loaded" by stalling up the converter and placing enough load to build boost before the vehicle even moves. Also, with an automatic transmission, the throttle is not shut during shifts which causes the boost to "pop up" because the turbo is supplying enough air flow to feed the boosted engine at high rpms and suddenly the rpms are drastically cut down by the shift as well as increased load has been placed on the system at the same time. This can cause an engine that is accelerating in 1st gear with low boost to instantly go to full boost upon shifting into 2nd gear.

Anti-lag is when a turbocharger is subjected to a very late burn causing the exhaust to expand in the turbine housing. This energy is concentrated at the turbocharger causing a very quick turbo spool up. The EMS supports two different types, including a rally style and drag race anti-lag.

User Definable Options for Drag Race Anti-Lag

Alt Ignition Fixed

Units: On/Off Description: Enables the **Alt Spark Fixed** option in order to maintain a constant ignition timing value for anti-lag.

Alt Spark Fixed

Units: Degrees Description: Sets a fixed ignition timing value while the alternate conditions are met. This is enabled by the **Alt Ignition Fixed** option.

Alt Spark Trim

Units: Degrees Description: Amount of ignition spark to be trimmed (+/-) when the alternate trims are active.

Alt Fuel Trim

Units: %

Description: Percentage of fuel to be added when the alternate trims are active.

Alt Off Above RPM

Units: Engine Speed Description: When above this rpm, the alternate trims and functions will deactivate.

Alt On Above RPM

Units: Engine Speed Description: When above this rpm, but below the **Alt Off Above RPM** the alternate trims and functions will activate.

Alt Off Below TPS

Units: %

Description: When below this throttle position, the alternate trims and functions will deactivate.

Alt On Above TPS

Units: %

Description: When above this throttle position, the alternate trims and functions will activate.

Alt Overboost

Units: Engine Load Description: When above this engine load, the alternate trims and functions will deactivate.

Alt On Above Load

Units: Engine Load Description: When above this engine load, but below **Alt Overboost** the alternate trims and functions will activate.

Alt Function Output

Units: User Defined Output Description: If the Alternate function is activated, this output channel will be activated also. Can be used to drive an LED, injector, etc.

Alt Function Input

Units: User Defined Input Description: Input switch that triggers the alternate function.

Channels (can be viewed or logged)

ALT

Units: On/Off Description: Displays the current status of the alternate function.

Fuel Trim (Alt)

Units: uS Description: Displays the fuel pulsewidth from the Alt Fuel Trim correction.

Tuning Drag Race Anti-lag

The basic idea is to fire the ignition after TDC to cause afterburn in the exhaust to spool the turbocharger to a desired boost level for launching the vehicle. There are a couple of things to consider to obtain the desired results.

Engine Speed: The amount of engine speed is directly related to how much boost can be made under anti-lag conditions. A higher engine speed will equate to a higher boost level as well as a faster boost response. If you are unable to make the desired boost pressure for launching, no matter how much ignition retard is used, then more than likely you need to increase the Alt On Above RPM.

Ignition Retard: The more the ignition is retarded, the more afterburn and heat will be put into the exhaust. Start at a conservative -10 degrees, and add more ignition retard until the desired time and boost is reached. Typical numbers are between 15 and -20 degrees of ignition. Either the Alt Spark Fixed or the Alt Spark Trim can be used for retarding the ignition.

Engine Load: If the boost control is set at "x" pressure, then no more "x" pressure can be obtained when launching. The option Alt Overboost, however, will allow a lower launch boost than the operating boost setting, by turning OFF the alternate function when the engine load has surpassed the option.

Additional Fuel: Added fuel will also aid in the anti-lag process by insuring the fuel mixture will be there throughout the engine cycle. A typical value for Alt Fuel Trim is 5-10%

Analog Input Switch

The AEM EMS can turn a 0-5V input into a switched input. This allows you to configure any analog channel with a switching point to activate. This is commonly used with shift retard with a 0-5V strain gauge. However, the analog input switch can be used for many other purposes. The analog input (**Switch #7**) works by setting a high and low voltage range with a throttle and engine speed threshold. When the input exceeds the range of the selected voltage and the other conditions are met, the switch will turn ON/OFF. If a shift cut/retard is to be used with **Switch #7**, see the **Shift Cut/Retard** section.

User Definable Options for Switch #7

Switch 7 Analog In

Units: Analog Input Description: User selectable analog input which is used to make a switched input. Typically used with shift retard function.

Switch 7 On Above

Units: Volts Description: Voltage threshold above which the **Switch #7** will be active. Should be set higher than **Switch #7 On Below**.

Switch 7 On Below

Units: Volts Description: Voltage threshold below which the **Switch #7** will be active. Should be set lower than **Switch #7 On Above**.

Switch 7 Min RPM

Units: Engine Speed Description: Speed threshold that you must be above for the **Switch #7** function to be met.

Switch 7 Min TPS

Units: Throttle % Description: Throttle threshold that you must be above for the **Switch #7** function to be met.

Channels (can be viewed or logged)

Switch 7

Units: On/Off Description: Displays the current status of the analog input **Switch #7** function.

Staged Injection

The AEM EMS has up to 10 individually controlled injector drivers (depending on the system). EMS-4 systems have 4 injector drivers. By default, they are assumed to be driving primary fuel injectors. Alternately, they can be defined as secondary, or "staged" injectors. These can be activated on an as-needed basis or by a user defined ratio between the two based on engine speed and load. The staged injectors are fully sequential with user defined, independent phasing.

User Definable Options for Staged Injection

Fuel Difference Map

Units: On/Off Description: When ON then the **Fuel Difference Map** is map is used to determine the % of fuel that will be routed through the secondary injectors.

Injector Min

Units: uS Description: If the calculated injector pulse (not including the battery offset injection correction) is below this value, no injection is performed.

Injector Duty Max

Units: % Description: This determines the maximum pulsewidth duty to the primary injectors when staged injection is being used. Once primary injector duty exceeds this, the EMS automatically puts all additional fuel to the secondary injectors. Typical value is 90%

Staged Flow Ratio

Units: % Description: Multiplier for staged injection. This tells the EMS the flow rate difference between the secondary injectors versus the primary injectors. If you have the same number & same size of secondary injectors as your primaries, this value is 100%. If you have secondary injectors that flow 3 times the primaries, the value is 33%. If you have 4 times secondaries, but only 2 (on a 4 cyl), the value should be 50%. Remember to account for the total primary flow rate (flow x number of injectors) and the total secondary flow rate (flow x number of injectors). This value must always be 100% or less, i.e. the secondaries must flow as much or more than the primaries.

Staged Flow 2 exp

Units: Multiplier Description: Multiplier used on the **Staged Flow Ratio** option to allow low flow secondary injectors. This is only used when the maximum flow rate of the primary injectors is greater than the maximum flow rate of the secondary injectors. Note: A value of "0" does nothing.

Diff Switch Input

Units: Switch Input Description: This assigns an input channel to activate the **Fuel Difference map**.

3-D Maps for Staged Injection

Fuel Difference map

Units: Fuel vs RPM vs Load Description: Allows a programmable fuel percentage when using the **Diff Switch Input** option.

	500	1000	1500	2000	2500	3000	3500	3750	4000	4500	4750	5000	5500	6000	6500	7000	7500	8000	8500	9000	9500
0.0	0.0	0.0	0.0	0.0	0.0	0.0	0.0	0.0	0.0	0.0	0.0	0.0	0.0	0.0	0.0	0.0	0.0	0.0	0.0	0.0	0.0
-0.9	0.0	0.0	0.0	0.0	0.0	0.0	0.0	0.0	0.0	0.0	0.0	0.0	0.0	0.0	0.0	0.0	0.0	0.0	0.0	0.0	0.0
-1.8	0.0	0.0	0.0	0.0	0.0	0.0	0.0	0.0	0.0	0.0	0.0	0.0	0.0	0.0	0.0	0.0	0.0	0.0	0.0	0.0	0.0
-2.6	0.0	0.0	0.0	0.0	0.0	0.0	0.0	0.0	0.0	0.0	0.0	0.0	0.0	0.0	0.0	0.0	0.0	0.0	0.0	0.0	0.0
-3.5	0.0	0.0	0.0	0.0	0.0	0.0	0.0	0.0	0.0	0.0	0.0	0.0	0.0	0.0	0.0	0.0	0.0	0.0	0.0	0.0	0.0
-4.4	0.0	0.0	0.0	0.0	0.0	0.0	0.0	0.0	0.0	0.0	0.0	0.0	0.0	0.0	0.0	0.0	0.0	0.0	0.0	0.0	0.0
-5.3	0.0	0.0	0.0	0.0	0.0	0.0	0.0	0.0	0.0	0.0	0.0	0.0	0.0	0.0	0.0	0.0	0.0	0.0	0.0	0.0	0.0
-6.1	0.0	0.0	0.0	0.0	0.0	0.0	0.0	0.0	0.0	0.0	0.0	0.0	0.0	0.0	0.0	0.0	0.0	0.0	0.0	0.0	0.0
-6.9	0.0	0.0	0.0	0.0	0.0	0.0	0.0	0.0	0.0	0.0	0.0	0.0	0.0	0.0	0.0	0.0	0.0	0.0	0.0	0.0	0.0
-7.8	0.0	0.0	0.0	0.0	0.0	0.0	0.0	0.0	0.0	0.0	0.0	0.0	0.0	0.0	0.0	0.0	0.0	0.0	0.0	0.0	0.0
-8.7	0.0	0.0	0.0	0.0	0.0	0.0	0.0	0.0	0.0	0.0	0.0	0.0	0.0	0.0	0.0	0.0	0.0	0.0	0.0	0.0	0.0
-9.5	0.0	0.0	0.0	0.0	0.0	0.0	0.0	0.0	0.0	0.0	0.0	0.0	0.0	0.0	0.0	0.0	0.0	0.0	0.0	0.0	0.0
-10.4	0.0	0.0	0.0	0.0	0.0	0.0	0.0	0.0	0.0	0.0	0.0	0.0	0.0	0.0	0.0	0.0	0.0	0.0	0.0	0.0	0.0
-11.3	0.0	0.0	0.0	0.0	0.0	0.0	0.0	0.0	0.0	0.0	0.0	0.0	0.0	0.0	0.0	0.0	0.0	0.0	0.0	0.0	0.0
-12.2	0.0	0.0	0.0	0.0	0.0	0.0	0.0	0.0	0.0	0.0	0.0	0.0	0.0	0.0	0.0	0.0	0.0	0.0	0.0	0.0	0.0
-13.0	0.0	0.0	0.0	0.0	0.0	0.0	0.0	0.0	0.0	0.0	0.0	0.0	0.0	0.0	0.0	0.0	0.0	0.0	0.0	0.0	0.0
-13.9	0.0	0.0	0.0	0.0	0.0	0.0	0.0	0.0	0.0	0.0	0.0	0.0	0.0	0.0	0.0	0.0	0.0	0.0	0.0	0.0	0.0

Channels (can be viewed or logged)

Fuel Diff

Units: % Description: Displays the current % of fuel (from the **Fuel Difference map**) that is being directed to the staged injectors.

Fuel Diff Trim

Units: % Description: Displays a programmable staged fuel trim parameter which can not be saved and is only for live tuning

Fuel Difference

Units: On/Off Description: Displays if the **Fuel Difference map** is currently being used for staged injection.

Fuel Inj Duty Pri

Units: %

Description: Displays the current injector duty cycle of the primary injectors.

Fuel Inj Duty Sec

Units: %

Description: Displays the current injector duty cycle of the staged injectors.

Fuel Inj Pulse Max

Units: uS Description: Displays the maximum available injector time for the current enginespeed.

Fuel Inj Pulse Pri

Units: uS Description: Displays the current pulsewidth of the primary injectors minus the **Battery Offset Primary Table**.

Fuel Inj Pulse Sec

Units: uS Description: Displays the current pulsewidth of the staged injectors minus the **Battery Offset Staged Table**.

Tuning Staged Injection

First, confirm that all of your primary injectors are defined properly. They must be "active" as well as defined as either **Primary** or **Secondary**. To do this, go to the Coils/Inj tab:

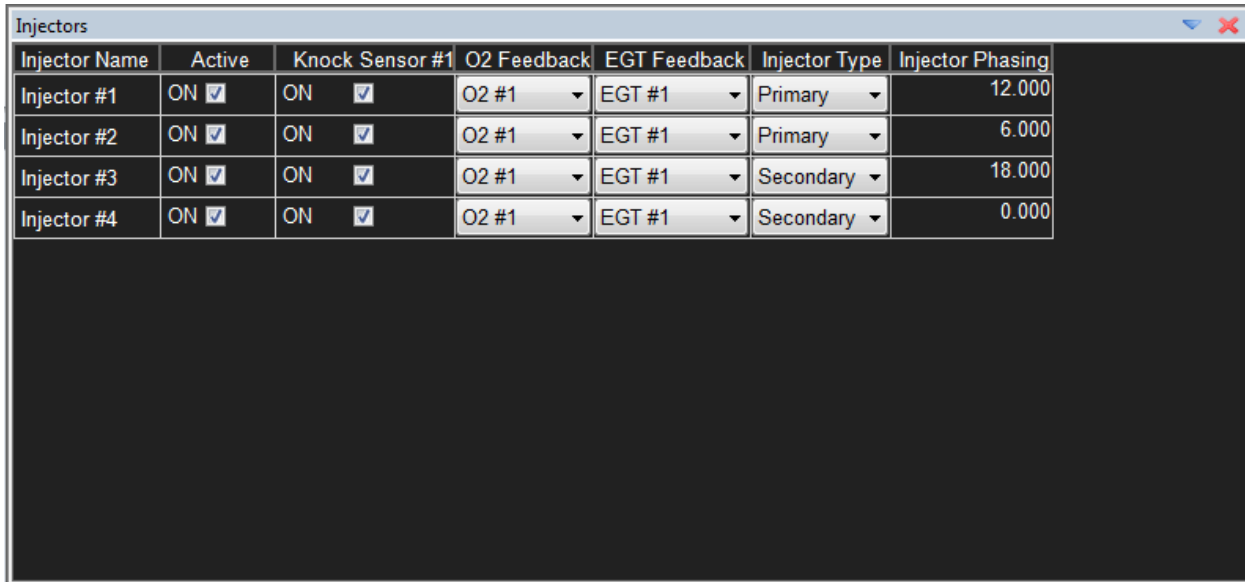

Injector Name	Active	Knock Sensor #1	O2 Feedback	EGT Feedback	Injector Type	Injector Phasing
Injector #1	ON <input checked="" type="checkbox"/>	ON <input checked="" type="checkbox"/>	O2 #1 ▾	EGT #1 ▾	Primary ▾	12.000
Injector #2	ON <input checked="" type="checkbox"/>	ON <input checked="" type="checkbox"/>	O2 #1 ▾	EGT #1 ▾	Primary ▾	6.000
Injector #3	ON <input checked="" type="checkbox"/>	ON <input checked="" type="checkbox"/>	O2 #1 ▾	EGT #1 ▾	Secondary ▾	18.000
Injector #4	ON <input checked="" type="checkbox"/>	ON <input checked="" type="checkbox"/>	O2 #1 ▾	EGT #1 ▾	Secondary ▾	0.000

In the example above Injectors #1 and #2 are defined as Primary and Injectors #3 and #4 are defined as Secondary.

You need to define where, in the engine cycle, you want the staged injectors to begin their injection pulse. This is set in the same manner as primary injectors and is done with the option Injector Phasing settings above. This value is in crankshaft pickup teeth (a.k.a. fuel teeth) after TDC #1 compression. This value is proportional to degrees of crankshaft rotation. It is actually quite helpful to understand that the EMS actually counts the number of crankshaft teeth passing until it gets to this number and then starts injection.

For a 12 tooth crank trigger wheel on a 4 stroke engine, there are 24 teeth per cycle (numbered 0 to 23.999). If the **Inject Tooth #6** was set to 6.5 teeth, that would tell the EMS to let 6.5 teeth pass ($720/24 \times 6.5 = 195$ crankshaft degrees into the cycle) and then activate **Injector #6**. It is important to note that this is not the final injection location, it is just a reference point. All primary and staged injectors are under control of the **Inj Advance Map**, which is a load vs. engine speed table that is used to set the actual injection phase.

The flow rate difference between the primary and staged injectors is necessary to accurately distribute the required fuel between the two different delivery systems. It represents the percent of primary injection time needed to flow an equivalent amount of fuel from the secondary injectors and is entered in the **Staged Flow Ratio** option.

Staged Flow Ratio = $((\text{number of primary injectors} \times \text{primary flow rate}) / (\text{number of secondary injectors} \times \text{secondary flow rate}) \times 100) - 100$

Remember, this is not simply the flow ratio between the 2 different injectors, it factors in the number of injectors as well. This number can range from -100 to +100. AEM Tuner includes a

setup wizard that will help define these flow difference options:

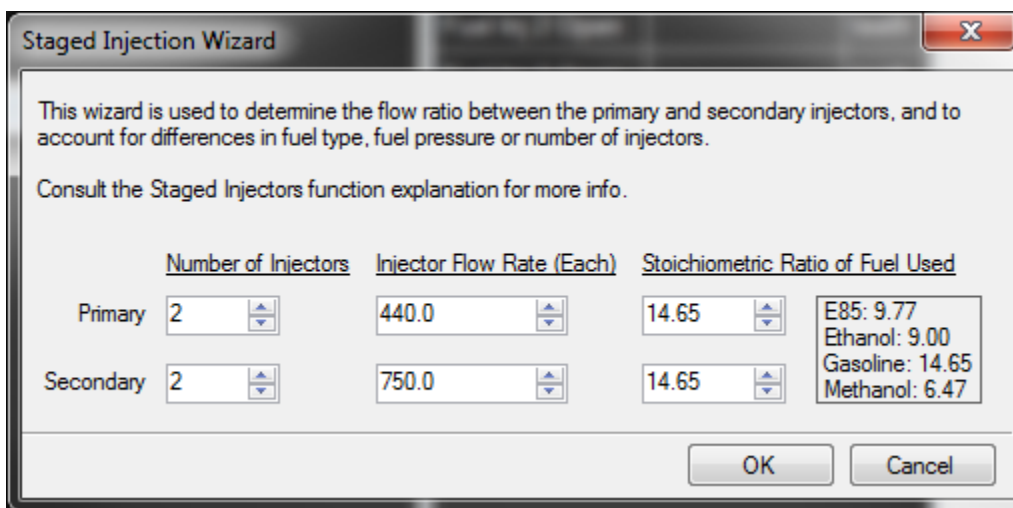
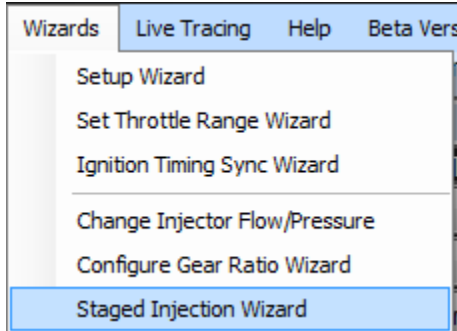

The example above defines 2 Primary injectors at 440cc/min each and 2 Secondary Injectors at 750cc/min each.

The last thing required to define the injectors is to tell the EMS how fast the injector responds to the fuel pulse signal. Under Trims tab is the **Battery Offset Staged** table. This is how long the secondary injectors take to start flowing fuel after they have been turned ON and is a function of battery voltage. There are actually 2 different tables, one for primary and the other for the staged injectors. Since the primary and staged injectors are usually different types, these tables should be different. If your injector response data is not represented in the wizards library, you can either select an injector from the same family or manually enter the data in the **Battery Offset Staged** table.

The staged injectors are now completely defined in software. The only thing remaining is to specify when and how much fuel should be directed to the new staged injection system. There are 2 different methods for transferring fuel from the main injectors to the staged injectors.

The most basic is based on the duty cycle of the primary injectors where you set the maximum injector duty you want to run through the primaries and the minimum ON time for the secondary

injectors. This sets the injectors to run only on the primary injectors until the base injector duty cycle exceeds the **Injector Duty Max** option. Once that has occurred, the fuel in excess of **Injector Duty Max** is routed to the staged injectors. The time set in the **Injector Min** option keeps the system from quickly switching back and forth between the two if the duty were to stay right at the **Injector Duty Max** threshold. The staged injectors will stay ON until the base injector duty cycle decreases below **Injector Duty Max**.

The second method for mapping fuel to the staged injectors uses the **Fuel Difference map** and the **Injector Duty Max** threshold in unison. The **Fuel Difference map** allows you to specify what percentage of fuel should be delivered via the staged injectors. The number entered into this map is the percentage of total fuel that will be delivered to the staged injectors. This can be set based on load and engine speed and gives the best control. To set this up you need to put the appropriate values into the **Fuel Difference map** and turn the **Fuel Difference Map** option to ON.

		RPM (rpm)																				
Fuel Difference		500	1000	1500	2000	2500	3000	3500	3750	4000	4500	4750	5000	5500	6000	6500	7000	7500	8000	8500	9000	9500
0.0		0.0	0.0	0.0	0.0	0.0	0.0	0.0	0.0	0.0	0.0	0.0	0.0	0.0	0.0	0.0	0.0	0.0	0.0	0.0	0.0	0.0
-0.9		0.0	0.0	0.0	0.0	0.0	0.0	0.0	0.0	0.0	0.0	0.0	0.0	0.0	0.0	0.0	0.0	0.0	0.0	0.0	0.0	0.0
-1.8		0.0	0.0	0.0	0.0	0.0	0.0	0.0	0.0	0.0	0.0	0.0	0.0	0.0	0.0	0.0	0.0	0.0	0.0	0.0	0.0	0.0
-2.6		0.0	0.0	0.0	0.0	0.0	0.0	0.0	0.0	0.0	0.0	0.0	0.0	0.0	0.0	0.0	0.0	0.0	0.0	0.0	0.0	0.0
-3.5		0.0	0.0	0.0	0.0	0.0	0.0	0.0	0.0	0.0	0.0	0.0	0.0	0.0	0.0	0.0	0.0	0.0	0.0	0.0	0.0	0.0
-4.4		0.0	0.0	0.0	0.0	0.0	0.0	0.0	0.0	0.0	0.0	0.0	0.0	0.0	0.0	0.0	0.0	0.0	0.0	0.0	0.0	0.0
-5.3		0.0	0.0	0.0	0.0	0.0	0.0	0.0	0.0	0.0	0.0	0.0	0.0	0.0	0.0	0.0	0.0	0.0	0.0	0.0	0.0	0.0
-6.1		0.0	0.0	0.0	0.0	0.0	0.0	0.0	0.0	0.0	0.0	0.0	0.0	0.0	0.0	0.0	0.0	0.0	0.0	0.0	0.0	0.0
-6.9		0.0	0.0	0.0	0.0	0.0	0.0	0.0	0.0	0.0	0.0	0.0	0.0	0.0	0.0	0.0	0.0	0.0	0.0	0.0	0.0	0.0
-7.8		0.0	0.0	0.0	0.0	0.0	0.0	0.0	0.0	0.0	0.0	0.0	0.0	0.0	0.0	0.0	0.0	0.0	0.0	0.0	0.0	0.0
-8.7		0.0	0.0	0.0	0.0	0.0	0.0	0.0	0.0	0.0	0.0	0.0	0.0	0.0	0.0	0.0	0.0	0.0	0.0	0.0	0.0	0.0
-9.5		0.0	0.0	0.0	0.0	0.0	0.0	0.0	0.0	0.0	0.0	0.0	0.0	0.0	0.0	0.0	0.0	0.0	0.0	0.0	0.0	0.0
-10.4		0.0	0.0	0.0	0.0	0.0	0.0	0.0	0.0	0.0	0.0	0.0	0.0	0.0	0.0	0.0	0.0	0.0	0.0	0.0	0.0	0.0
-11.3		0.0	0.0	0.0	0.0	0.0	0.0	0.0	0.0	0.0	0.0	0.0	0.0	0.0	0.0	0.0	0.0	0.0	0.0	0.0	0.0	0.0
-12.2		0.0	0.0	0.0	0.0	0.0	0.0	0.0	0.0	0.0	0.0	0.0	0.0	0.0	0.0	0.0	0.0	0.0	0.0	0.0	0.0	0.0
-13.0		0.0	0.0	0.0	0.0	0.0	0.0	0.0	0.0	0.0	0.0	0.0	0.0	0.0	0.0	0.0	0.0	0.0	0.0	0.0	0.0	0.0
-13.9		0.0	0.0	0.0	0.0	0.0	0.0	0.0	0.0	0.0	0.0	0.0	0.0	0.0	0.0	0.0	0.0	0.0	0.0	0.0	0.0	0.0

Additionally, there is a switch input available, called **Diff Switch Input** where the staged injection can be disabled from the cockpit. If this is used, it needs to be assigned to a switch input. If only the software operating criteria is used, set the **Diff Switch Input** to **Switch is Always On**. This says the switch is always ON so only the software criteria is used. It is important to remember that the **Injector Duty Max** limit will still be used so set that value to a reasonable number.

You can view and/or log the actual base injection times with the **Fuel Inj Pulse Pri** and **Fuel Inj Pulse Sec** channels. You can view and/or log the actual injector duty cycles with the **Fuel Inj Duty Pri** and **Fuel Inj Duty Sec** channels. To view the current battery Injector offsets, use the

Fuel Trim Bat-Pri and **Fuel Trim Bat-Sec** channels. To determine how the **Fuel Difference Map** is being used, monitor the **Fuel Difference**, **Fuel Diff Trim** and **Fuel Diff** channels.

Switched Ignition Retard/Cut

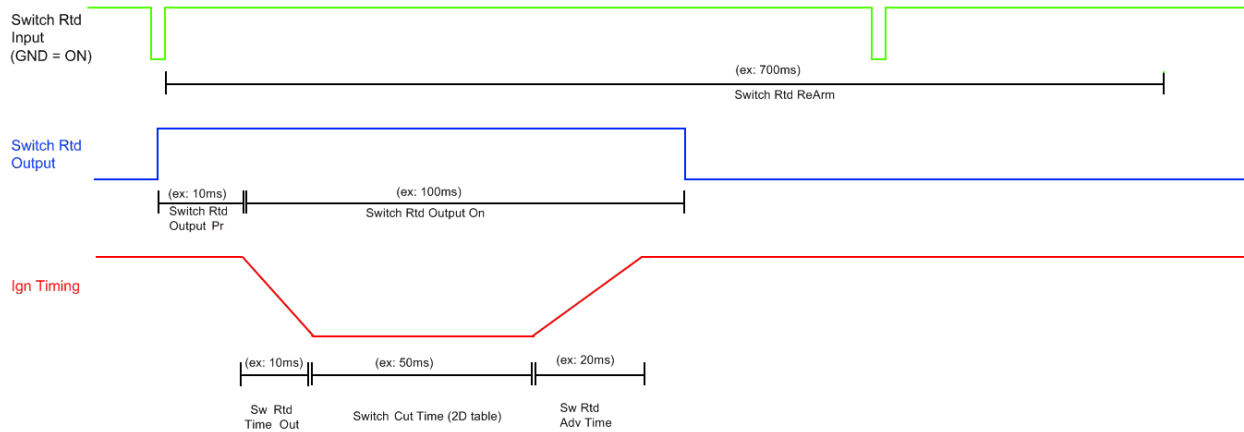

Switch Retard Output Pr:

This option allows the output pin to be activated for a controlled amount of time prior to the timing retard/cut happening. This allows the system to prime the pneumatic actuator before decreasing engine power. For use with air-shifting systems only, set this value to zero for driver-shifted gear levers. Recommended values: 10-50ms

Switch Rtd Time Out:

Time during which the ignition is decreased or 'ramped out' as opposed to immediately changing to max retard. (Recommended values: 10-50ms)

Switch Rtd Max Rtd:

Maximum ignition retard value. (Recommended values: 20-40 degrees, depending on original ignition timing map)

Switch Cut Time table:

Time during which the ignition remains at the max retard. Can be adjusted for each gear. (Recommended values: 80-150ms)

Switch Rtd Adv Time:

Time during which the ignition is increased or 'ramped back in' as opposed to immediately changing back to original ignition table values.

Switch Rtd ReArm:

Wait time between shift events. Intended to prevent extra shift events if the switch is pressed too early or held for too long.

Switch Rtd Advance:

Defines the ignition timing step sizes applied as the timing is ramped back in.

Switch Rtd Ign Cut:

Turn on if you want the system to cut ignition after the timing is ramped out. See Switch Cut Time table description above.

Switch Rtd Input:

Defines the GPIO input used to activate the function. Must be set to GPIOX Gnd = On. Switch input must be wired through the switch to ground.

Switch Rtd Output:

Defines the low side (switched ground) output used to activate an air shift control solenoid. See Switch Retard Output Pr above.

Switch Rtd Output On:

See diagram above. Controls the on-time of the control output.

Switch Rtd Step:

Defines the ignition timing step sizes applied as the timing is ramped out.

Glossary of Terms

4 Stroke Cycle

Intake - During the intake stroke, the piston is moving from top to bottom and the intake valve is open. As the piston moves down, a vacuum is created which draws the air/fuel mixture into the combustion chamber. The intake valve is closed after the piston reaches the bottom. This position is normally called bottom dead center (BDC)

Compression - During the compression stroke, the piston moves up and compresses the air/fuel mixture against the cylinder head. When the piston is near the top of the stroke (the top of the stroke is typically called top dead center, TDC), the ignition system produces a spark at the spark plug. The spark ignites the mixture which creates a rapid rise in cylinder pressure.

Power - During the power stroke, the high pressure gases produced by the burning of air/fuel mixture force the piston back down the cylinder bore. This is the only stroke that actually produces useable power from the engine.

Exhaust - During the exhaust stroke, the piston moves upward. The exhaust valve is open and the piston forces the spent gases out the exhaust port and into the exhaust system.

5 Volt Reference

The high voltage reference for most automotive analog sensors. Typical three wire sensors will have a high reference, a low reference and a signal output. The signal output will always fall between the low and high reference points.

Air / Fuel Ratio

In engine testing, both the air mass flow rate and the fuel mass flow rate are normally measured. The ratio of these flow rates is useful in defining engine operating conditions. The normal operating range for a conventional spark ignited gasoline burning engine is between 12:1 and 18:1. Turbo/supercharged engines typically operate even richer with air/fuel ratios as low as 11:1. The most common way to measure Air/Fuel ratio for engine calibration work is by using an oxygen sensor in the exhaust stream.

Analog Circuits

Electrical circuits that amplify or alter a voltage signal to represent some physical quantity.

Atmospheric Pressure

Normal pressure in the surrounding atmosphere generated by the weight above us pushing down. At sea level, in average weather conditions, atmospheric pressure is approximately 100 kPa (about 14.5 psi) above vacuum or zero absolute pressure.

Base Idle

Idle RPM when the throttle lever is at rest on the throttle stop and the idle speed control function is disabled.

BDC

Bottom dead center; the extreme lowest position of the piston during its stroke.

Boost

Describes positive pressure in the intake manifold relative to atmospheric pressure. Standard atmospheric pressure is 14.5 psia. 10 psi of boost would result in 24.5 psia in the manifold.

Breakpoints

Define the axis values on two dimensional or three dimensional lookup tables

BSFC

Brake Specific Fuel Consumption or BSFC is the fuel flow rate per unit power output. It measures how efficiently an engine is using the fuel supplied to produce work.

Calibration

Engine calibration in its most basic form is the setting of the air/fuel ratio and ignition timing for the engine. Modern electronic engine control systems serve many more functions though. These can include: idle control, automatic transmission control, turbocharger boost control and knock control. The engine controller can also be used to enable/disable ancillary functions like emissions control solenoid valves (EVAP/purge, air injection), air conditioner compressor clutch relays, etc. The engine calibrator is responsible for configuring and tuning all of these items to satisfy the performance requirements for the engine.

Capacitor

An electronic device that stores electrical charge.

Closed Loop Fuel Control

An engine control mode of operation where the air/fuel ratio is controlled by varying the fuel flow rate in response to the rich/lean indication from an exhaust

Coil

For ignition system is comprised of two sets of insulated wire wound around a common ferrous core. The primary winding is typically made up of tens or hundreds of turns of course wire. The secondary winding is made up thousands of turns of fine wire. A single set of coil windings can be used to build a solenoid that converts electrical field energy into mechanical movement.

Coil on Plug

Refers to ignition systems that include one coil for each spark plug. Most modern automotive ignition systems are of this type.

Cold Start

Starting the engine when it is cold; when the engine has not run for several hours.

Combustion

The burning of the fuel-air mixture in the cylinder.

Combustion Chamber

Space left between the cylinder head and the top of the piston at TDC; where combustion of the air-fuel mixture takes place.

Compression Ratio

The ratio of the cylinder volume at BDC to the volume at TDC.

Options

Single value in an engine calibration. Can sometimes be referred to as an option. Options and tables (2D and 3D) make up the tuneable portion of an engine calibration file.

Continuity

Little or no resistance in an electrical circuit to the flow of current. A solid electrical connection between two points in a circuit. The opposite of an open circuit.

Controller

In automotive electronics, refers to a module made up of semiconductor circuits sometimes containing imbedded software code.

Data

Information calculated or obtained directly from sensor inputs to a controller.

Data Analysis

The task of interpreting information obtained from engine sensors and controller calculations.

Density

The ratio of the mass of something to the volume it occupies. Air has less density when it is warm and less density at higher altitudes.

Digital Circuit

Electronic circuits whose outputs can change only by specific amounts and between a limited number of different voltages.

Stoichiometric

The air/fuel ratio for complete combustion; all the fuel is burned using exactly all the oxygen in the air. For gasoline, this ratio is 14.7:1 or 14.7 parts of air to 1 part fuel.

Display

Device used to indicate information in a human readable form.

Drivability

Condition describing a car in which it starts easily and idles, accelerates and shifts smoothly and with adequate power for varying temperatures.

Driver

In automotive electronics, refers usually to a transistor circuit that is designed to either source or sink electrical current.

Duty Cycle

In components which cycle on and off at a given frequency, the measurement of the amount of time the component is on versus the time it is off.

Dwell

The amount of time that current is flowing through the primary side of the ignition coil. Dwell measurements can be expressed in either units of time (usually milliseconds) or crankshaft degrees.

ECU

Engine Control Unit. Refers to an electrical module that receives inputs from sensors and outputs signals to actuators on an engine. Can also be referred to as EMS, PEMS, etc.

Emissions

Chemical by-products of combustion; comprised primarily of carbon monoxide (CO), hydrocarbons (HC) and nitrous oxides (NOX).

Engine Calibration

The values contained in the controller program that are adjustable by the tuner and are used to control engine operation, primarily fuel and spark requirements.

Engine Mapping

A procedure of experimentally determining the performance of an engine at selected operating points and recording the results.

Equivalence Ratio

Actual air/fuel ratio divided by the air/fuel ratio at stoichiometry.

Export

To output information or data from one piece of computer software for use in another.

Gain

In closed loop control terminology, refers to constants that vary the magnitude of each term in the manipulated variable calculation or algorithm.

Hall Effect Position Sensor

Type of sensor used in all Pro Flo distributors for measuring crankshaft position. Outputs a square wave signal pattern that is either low (ground) or high (reference voltage) depending on whether or not a tooth is passing near the sensor.

Hg

The chemical representation for the element Mercury.

High Impedance

Refers to injectors that have coil resistance values of 12.0 ohms or more

Hot Keys

Single or combinations of key strokes that can be programmed to perform certain tasks.

Import

To receive information or data from one piece of computer software for use in another.

Inches Hg

A relative measure of pressure or vacuum.

Injector

Solenoid actuated fixed orifice valve used to inject precise amounts of fuel

Integrated Circuit

A semiconductor device that contains many circuits on a single chip.

Lambda

Term referring to the oxygen sensor itself or the data obtained from an oxygen sensor that represent the air / fuel ratio of the engine. The lambda value is a ratio and is therefore unit-less.

Load

In fuel injection calibrations, a term used to scale the demand on an engine. Commanded fuel, spark and other variables are assigned in the calibration file based on the load and current operating mode of the engine.

Lookup Table

A table in software that equates one variable to another.

Low Impedance

Refers to injectors that have coil resistance values of 2.5-3.0 ohms

Macro

A feature of some computer software programs that allows a number of repeated tasks to be combined and performed on command.

Math Channel

In data analysis software, a channel calculated using raw data and mathematical functions. Can be included in a plot with other data.

mS

Abbreviation for millisecond or one thousandth, 0.001 seconds.

Open Loop Fuel Control

Method of controlling fuel flow without modification from a feedback variable such as oxygen content.

Outing

In data analysis software, refers to a complete set of data.

Parallel Circuit

Contains two or more circuit elements that have the same voltage measured across each.

Peak and Hold Driver

A driver that uses two levels of current to operate the injector. The driver circuit applies battery voltage to the injector until a predetermined current level is reached. The current is then reduced and held at a lower level for the duration of the PW. This type of driver is normally used with injectors having low resistance coils (typically around 2 ohm). The accuracy of the driver peak current level (Ip) and the hold current level (Ih) is held to $\pm 0.50\%$.

Permanent Power

Sometimes referred to as "Perm" power. This is uninterrupted battery power. Typically a direct connection to the battery positive terminal.

Pickup

Term that sometimes refers to frequency measurement sensors such as crank or cam position.

Pigtail

One or more wires terminated only on one end. Sometimes specialized automotive connectors are supplied with a short piece of wire installed in each cavity. Can be spliced into an existing harness.

Pinout

Refers to the description of each circuit or pin on a connector.

Power

Power is the rate at which work is done. It is the product of torque and angular speed.

psi

Abbreviation for pounds per square inch, a unit of pressure measurement.

psia

Abbreviation for pounds per square inch absolute. A unit of pressure measurement relative to a perfect vacuum.

RS232

A common standard used in serial communication between a PC and an engine controller.

RXD

Abbreviation for Receive Data.

Saturated Driver

A power transistor driver that turns fully on for the entire duration of the injector PW. This type of driver is used with injectors having high resistance coils (typically 12 to 16 ohm) or with injectors having low resistance coils in combination with a ballast resistor

Sensor Calibration

Sensors used on EFI systems output a voltage that is proportional to whatever the sensor is monitoring, manifold pressure, coolant temperature, etc. A calibration curve is a 2 dimensional lookup table that assigns sensor voltage settings to values in particular engineering units. Manifold pressure will be calibrated in units of pressure, coolant temperature will be calibrated in units of temperature, either Fahrenheit or Celsius, etc.

Sensor Ground

Also known as analog ground or low reference. The voltage output from a sensor is always relative to some reference. Most analog sensors use a clean 5 volt high reference and a clean low reference or sensor ground. Sensor grounds are actually outputs from the ECU. The engine controller isolates and filters these reference grounds so they are not affected by stray electrical noise.

Serial

In communication hardware, serial refers to sending data sequentially, one bit at a time over a communication channel or cable.

Series Circuit

Two or more circuit elements are said to be in series if the same current flows through each of the elements.

Spark Timing

Time measured in degrees of crankshaft rotation between the spark plug firing event and top dead center for that cylinder.

Stoichiometric

The air/fuel ratio for complete combustion; all the fuel is burned using exactly all the oxygen in

the air. For gasoline, this ratio is 14.7:1 or 14.7 parts of air to 1 part fuel.

Switch

A device that can break an electrical connection interrupting the current or diverting it from one conductor to another.

Switched Ground

Using an electromechanical or electronic switch to connect a circuit element to a ground reference.

Switched Power

Battery power provided to the system when the ignition switch is in both the "run" and "start" positions.

Tile

Software feature allowing multiple windows to be displayed at once.

Torque

Torque is a measure of an engine's ability to do work. Engine torque is normally measured with an engine dynamometer.

Trims

Alternate term used to describe correction tables in an engine calibration file.

TXD

Abbreviation for Transmit Data

uS

Abbreviation for microsecond or one ten thousandth of a second or 0.0001 seconds.

USB

Universal Serial Bus (USB) is a serial bus standard to connect devices to a computer. Other convenient features include providing power to low-consumption devices, eliminating the need for an external power supply; and allowing many devices to be used without requiring manufacturer-specific device drivers to be installed.

Vacuum

Vacuum is measured in units of pressure. In automotive technology, vacuum is often measured using inches of mercury on the barometric scale or as a percentage of atmospheric pressure in bars or atmospheres. Low vacuum is often measured in inches of mercury (inHg) below atmospheric pressure. "Below atmospheric" means that the absolute pressure is equal to the current atmospheric pressure (e.g. 29.92 inHg) minus the vacuum pressure in the same units. Thus a vacuum of 26 inHg is equivalent to an absolute pressure of 4 inHg (29.92 inHg - 26 inHg). The reciprocating motion of the pistons in an internal combustion engine create a vacuum

in the manifold.

Volumetric Efficiency

The intake system on a spark ignited engine, restricts the amount of air that an engine of a given displacement can flow. The parameter used to measure the effectiveness of an engine's induction process is the volumetric efficiency. It is defined as the volume flow rate of air into the intake system divided by the rate at which volume is displaced by the piston.

Wasted Spark

A wasted spark is when in an ignition system in a four-stroke cycle internal combustion engine spark plugs fire in pairs, on both the exhaust and compression strokes. The extra spark on the exhaust stroke has no effect and is thus "wasted". This design is simpler than a conventional ignition system, but the extra sparks reduce the lifespan of components (contact breaker, spark plugs).

XY Plot

In data analysis, a plot of one variable versus another rather than time.

Index

2Step Rev Limiter, 5, 240, 241
30-6905 kit, 10
Air Temp Sensor, 27
Analog Input Switch, 5, 257
Anti-Lag, 5, 254, 255
autoignition, 184
backshell, 10, 12
Boost Control, 5, 214, 220, 222
Calibration Compare Tool, 59
Calibration File, 40
Cam Count, 103, 141
Cam Sensor, 33, 34
CAN enabled devices, 19
CDI, 25
Change Injector/Pressure Wizard, 72, 73
Channels, 40
coil driver, 22, 23, 25
compression ratio, 141, 185
Configure Gear Ratio Wizard, 73, 74, 238
Configure Output Dialog, 57
Configure Telemetry Dialog, 59
Convert Current Calibration Tool, 61
Coolant Temp Sensor, 28
CPU Core, 7
Crank Advance, 146
Crank Count, 142
Crank Fuel & Engine Start, 5, 146
crank sensor, 29, 30, 31, 102, 104
Crank Sensor, 29, 32, 33
Crank Tooth Period, 142
Display Explorer, 46
Distributed spark, 22
Download EMS Log, 56, 213
dwell, 24, 25, 109, 111
Editing 2D Table Displays, 3, 82
Editing 3D Map Displays, 4, 91
Editing Channel Displays, 3, 90
Editing Options Display Data, 81
EMS Connection Preference, 52, 53
EMS-4 GPIOs, 5, 196
Firmware, 37, 52
Flattening, 88, 89
Fuel Delivery Hose Sizes, 4, 135
Fuel Hoses and Routing, 4, 134
fuel injector, 20
Fuel Phasing and Injector Setup, 4, 104
Fuel Pressure Regulator and Pulse
 Dampener, 4, 137
fuel pump, 18
Fuel Pump Location, 4, 134
Fuel Pump Setup, 4, 132
Fuel Pump Sizing, 4, 133
Fuel System Setup, 4, 132
Fuel Teeth, 103
Fuel Tooth, 142, 143
Fuel Tuning, 4, 5, 99, 156
Fuel Tuning General Concepts, 4, 99
Function Explanations, 41
GPIO, 7
Hotkeys, 65
Idle Air Control, 5, 36, 148
Idle Tuning Procedure, 155
Ignition Map, 5, 190, 193
Ignition Phasing and Coil Dwell Discussion,
 4, 107
Ignition Synchronization, 4, 144
Ignition Timing Sync Wizard, 72, 144, 145
Ignition Tuning Theory, 5, 179
Interpolation, 85, 86, 96
Item Explanations, 41
Knock Control, 5, 229
Knock Sensor Cal table, 229
Linear Extrapolation, 87
LIVE TRACING, 75
log run time, 56, 213
LOGGING, 53
Logging Conditions, 54, 211
MAP (Manifold Pressure Sensor), 4, 114
MAP Sensor, 26, 27
Maps, 40
Menu Items, 3, 42, 59
Mini Harness, 10
Nitrous Control, 5, 173, 250
O₂ (Oxygen) Sensors, 4, 118
O2 Feedback, 5, 105, 173, 243, 245, 247
Options, 40, 45, 46
PC Logging, 53, 66, 206, 207
Preferences, 45, 62, 63, 64, 65, 66, 67, 68,
 69, 76, 81, 83, 93, 208
Preignition, 181, 183
proper wiring, 16
relay, 10, 17, 18, 36, 140, 200, 250, 251
Sensor Calibration, 4, 124, 128, 129, 271
Set Password, 51, 52
Set Throttle Range Wizard, 71, 128, 129
Set up RPM and Load axes, 4, 112
Setup Wizard, 70, 71, 125, 127
Software Downloads Link, 37

Software Installation, 37, 38, 39
Spark Plugs, 179
Spark Teeth, 103
Spark Tuning General Concepts, 4, 100
Squish, 185
Staged Injection, 5, 74, 258, 259, 261
Staged Injection Wizard, 74
Stat Sync'd, 142
Switch 7, 202, 203, 204, 206, 257
Sync Errors, 142
Tables, 40, 45
Tabs, 40, 48, 49
Timing Errors, 142, 143

Timing Pattern Basics, 4, 101, 104, 140, 142
Timing Pickup Confirmation, 4, 140
TPS sensor, 71, 128
Traction Control, 5, 173, 231, 236, 238
Transistors, 109
Upload Calibration, 50, 51
USB, 19
USB communications, 19
Vehicle Speed Sensor, 35
Wasted Spark, 22, 273
Water Temp Sensor, 28, 118
Workspace, 41, 43, 44, 49