



Defi-Link **ADVANCE** **Control Unit**

デフィーリンクアドバンスコントロールユニット取扱説明書
Defi-Link ADVANCE Control Unit Operation Manual

DF07701

日本国内でご購入の場合は 1 ページから 39 ページをお読みください。

このたびは、当社製品をお買い上げいただきまして、誠にありがとうございます。お客様・取付業者様ともに、ご使用前に本書を全て必ずお読みいただき、取付後も常にお手元に保管し、正しいお取り扱い方法でご愛用いただけますようお願い申し上げます。

なお、本品の装着に関する事故や弊害につきましては、いかなる場合においても、当社は一切責任を負いかねますので、あらかじめご了承ください。よろしくお願い申し上げます。

※英語の部分は国内では無効です。

【Web サイト】 <http://www.nippon-seiki.co.jp/defi/>

【電話番号】 (03)3835-3639

【受付時間】 9:30 ~ 12:00、13:00 ~ 17:00(土・日、祭日、当社休日を除く平日)

English section is from P.40 to P.81.

Thank you very much for purchasing our product. Before installing and using the product, please read this manual thoroughly. All sections are for customers and installation personnels. After installation, please keep this manual for future reference.

Defi will not be held responsible for accidents or damages related to installation of this product.

※ Japanese section is effective only in Japan.

【Web site】 <http://www.defi-shop.com/>

もくじ Contents

もくじ Contents	1
❶安全・取り扱いに関するご注意【必ずお読みください】	2
❷特長	8
❸ラインナップ・価格	8
❹仕様	10
❺構成部品・各部名称・寸法	11
❻取付方法	14
❼使用方法	21
❽トラブルシューティング	33
❾補修パーツ・オプションパーツ	36
❿保守・点検・保証・アフターサービス	37
① Safety Warning 【Please read carefully.】	40
② Product Features	46
③ List of Products	46
④ Specification	48
⑤ Parts List/Part Names/Dimensions	49
⑥ Installation	52
⑦ Operation	59
⑧ Troubleshooting	72
⑨ Repair parts/Optional parts	75
⑩ Maintenance & Check/Warranty & Servicing	76



1 Safety Warning [Please read carefully.]

This product is a required for ADVANCE gauges and displays. This product alone does not operate. Please use this product with ADVANCE gauges or displays. As for installation and operation, please refer to the manual for the gauges and displays as well.



This product is an additional product for providing information to automobile users about engine conditions and other important factors. When installing and operating this product, be sure to read the cautionary items of this operation manual as well as those given in the operation manual for the vehicle in which this product will be installed. Please obtain a full understanding of the cautionary items and use the product accordingly.

In the event that this product (or the vehicle in which it is installed) is lent to or transferred to another person, please be sure this operation manual and warranty card accompany the product.

In this manual, the degree of hazard arising from actions such as improper operation is separated into the 3 levels "Danger," "Warning," and "Caution." In addition, instructions that must be followed for safe and proper use of this product as well as practices that must be maintained are marked with a "Confirmation" heading. Please read and become familiar with these sections.









 Danger	Indicates the imminent dangerous situation of death or serious injury if the product is mishandled
 Warning	Indicates the possibility of death or serious injury if the product is mishandled.
 Caution	Indicates a conceivable source of personal injury or damage to equipment if the product is improperly operated.
Confirmation	Indicates an instruction that must be performed or practice that must be maintained.

Properties for safety warning

	Indicates attention needs to be paid. (Including warnings)
	Indicates restricted actions. (PROHIBITED actions)
	Indicates actions that need to be carried out. (MUST actions)

■ Before handling (for installation personnel)

Danger

-  Ensure that the vehicle will remain stationary and turn off the engine before installing this product. Failure to do so could result in a fire, and could make the vehicle move during installation.
-  Remove the key from the ignition and disconnect the negative (-) battery terminal prior to installation of this product. Failure to do so could result in a fire caused by an electrical short circuit.
-  Take care not to install this product in a way that interferes with safety equipment such as seat belts and air bag systems or vehicle operation equipment such as engine controls, steering wheel and brake systems. Interference with normal operation of the vehicle can result in an accident or fire.
-  Solder or use a solderless connector for wiring connections and make sure connections are insulated. In areas where there could be tension or sudden impacts on the wiring, safeguard the wiring with corrugated tubing or other shock absorbent material. Accidental shorts can cause fires.
-  While wiring power supply wire, to avoid the risk of electrical shock or fire, be sure to confirm that there is no disconnection or breakage of wire. Poor connection can result in short-circuit, electrical shock, fire, or other hazards.
-  The ignition-switched +12V(IGN) line must be connected to the vehicle's ignition-switched wire with a fuse of 30A or less. High-capacity fuse(more than 30A) will not blowout even with an abnormal current flow and may cause fire.
-  Use the tube fuse of regulated capacity when the fuse of the power wire is changed. Using a fuse that exceeds regulated capacity may cause fire.
-  Do not install the product in wet places. It may result in a fire caused by an electrical short circuit.

Warning

-  Carefully consider the installation location and driver's operation of the product before installation. Do not install the product where it interrupts driving and the safety deices of vehicle such as air bags. Be sure not to

install the unit where it could fall. Improper installation or operation could cause the product to fall and damage the vehicle or cause serious danger by impeding driving.

- ⊘ Do not disassemble or modify this product. Such actions can not only damage or destroy the product but also will void the warranty.
- ⊘ Do not perform installation of this product immediately after the engine has been switched off. The engine and exhaust system are extremely hot at this time and can cause burns if touched.
- ⓘ Ensure that the wiring of this product does not have an adverse impact on the other wiring of the vehicle. Before tapping speed or engine rev signal from the ECU, please make sure that you have connected power cables inside power supply wire properly. Then confirm that the DC Source LED is lighted with ignition on. If it is functioning normally, remove negative terminal connector from battery and go ahead with wiring procedure. Incorrect wiring may destroy your ECU, ignition system and other engine management devices.
- ⓘ Discontinue use of this product if the product doesn't operate or operates improperly. Continued use while the condition exists could result in an accident or damage.
- ⊘ Please keep children and infants away from the installation area. Children may swallow small parts or be injured in other ways.
- ⊘ Do not install this product in the area where safety equipment such as air bags are mounted. This may cause more injuries in the event of accident.

Caution

- ⓘ This product is designed for use on 12V vehicles. Do not install this product on vehicles with 24V systems.
- ⓘ Insulate any unused wires. If any wires or connectors loosen during installation, please make sure they are correctly reattached.
- ⊘ Do not drop any of the components of this product. It may result in damage to the product.
- ⊘ Do not apply excessive force on switches/terminals. It may result in damage to the product.



- ⊘ Do not use wires other than the provided wires.
- ⊘ Do not attach wires on the body of the vehicle or engine parts as this may result in damage to the product.
- ⚠ Install wires away from ignition and also radio signal frequency interference as this could cause the gauges to malfunction.
- ⚠ Please set it up so that the equipment such as the wireless machines and cellular phones that emit electric waves should not touch the unit. It may result in incorrect operation.
- ⊘ Do not place wires near the engine, exhaust pipe or turbine. It may result in damage or fusion of wires.
- ⚠ Make sure the waterproof processing is done when diverging wires in the engine compartment.
- ⊘ Do not lay the gauge face down due to oil leakage.
Angle "A" must be more than 90 degrees.
- ⚠ When installing the sensor, do not bend the wire near the sensor body.
- ⓘ Wear gloves to avoid burns when soldering and cuts when installing wires, sharp edges of parts.
- ⊘ Do not expose the unit to moisture, dust or direct sunlight, or place product directly in front of heat vents.
- ⓘ Install sensors away from hot or wet places.
- ⓘ When using sunshade, put sunshade between products and windshield to avoid direct sun exposure.
- ⚠ Use the dried soft cloth for cleanup. Do not use the cleaner except for the neutral detergent. It results in trouble.
- ⊘ Do not pull the wires out of connectors forcefully. The connectors may be broken and the wires may be cut. When pulling out the wires, press the lock firmly to unclip the locks of connectors.
- ⊘ Do not install gauges, including this product, into the passenger side or center of the dashboard. It doesn't meet vehicle safety standards.

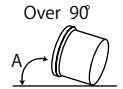

Confirmation

- ⓘ Be sure to follow all instructions in this manual to ensure safe installation and operation of the product.

- ⚠ When the negative (-) battery terminal is disconnected, equipment such as clocks and audio components having internal memory may lose their memory data. Follow the operation manual of each component to reset data after installation of this product.
- 🔧 After installation is complete, return this operation manual, warranty card, and the package along with the warranty to the customer .
- ⚠ The gauge pointer may not be in the proper position when you purchase the product. Normal function will resume when power is connected.
- 🔧 Please confirm with the maintenance book that the car manufacturer issued when installing and detaching genuine parts.
- 🔧 Before tapping wires, check the voltage of the existing wire. After tapping the wire, check the voltage of the tapped wire again to confirm whether you have tapped into the proper place.
- ⚠ If car navigation system or car television is installed in vehicle, gauges and wires of this product need to be kept as far away as possible from the wiring and installing positions of car navigation system or car television. Failure to do so may result in interference of television display(VHF).
- ⚠ On no event will Nippon Seiki Co., Ltd. be liable to you for any damages or losses of genuine parts for your vehicle while installing.

■ About Installation and Operation (for customer and installation personnel)

⚠ Warning

- 🔧 Please have this product installed by store professional or dealer where it was purchased. Installation by the customer will void the warranty.
- 🚫 Do not disassemble or modify this product. Such actions will not only void the warranty but also damage or destroy the product .
- 🔧 In order to ensure safe driving, check the information on the gauge only for a short period of time. Looking at the display for a long period of time could distract attention from the road and result in an accident.
- 🔧 Discontinue use of this product if the gauge doesn't operate, water gets into the unit, or smoke or a strange odor comes from the unit. If such a condition occurs, contact the store or installation personnel as soon as possible. Continued use while the condition exists could result in an accident or fire.



- 🚫 Do not operate while driving.
- 🔧 Fix the switch unit and other parts tightly to the vehicle to avoid children's accidentally swallowing them.
- 🚫 Do not use the TIME ATTACK function of ADVANCE ZD in open roads. It is only for closed courses.

⚠ Caution

- ⚠ On no event will Nippon Seiki Co., Ltd. be liable for any damages arising out of the use or inability to use the product, even if Seiki Co., Ltd. has been advised of the possibility of such damage.
- 🚫 Do not pull the wires out of connectors forcefully. The connectors may be broken and the wires may be cut. When pulling out the wires, press the lock firmly to unclip the locks of connectors.

Confirmation

- ⚠ This product cannot be linked to the previous version of Defi-Link System.
- 🔧 The information displayed on this product are for reference purposes only. Please drive according to the indication of vehicle's originally equipped instruments.
- 🚫 Do not connect more than one gauge of the same variety. (Ex. You can NOT connect 2 turbo gauges together.)
- ⚠ This product can be used only on 1, 2, 3, 4, 5, 6, and 8 cylinder vehicles with 4 cycle engine. This product cannot be used on diesel vehicles.
- 🔧 Please check the installed product regularly. Durability might deteriorate according to use conditions, etc.

2 Product Features

- Interactive communication advanced system is implemented.
- Up to 7 ADVANCE gauges and displays in all can be controlled.
- Gauges can be controlled from distance with the included switch unit. The illumination color is white.
- By connecting ADVANCE ZD to the ADVANCE system, the illumination of ADVANCE BF and CR gauges is controlled automatically.
- Opening and ending modes can be selected from 2 variations.
- The installation of additional gauges is easy. Just connect it to other gauge and attach the sensor to ADVANCE Control Unit.
- Self-diagnosis system turns on the warning display to indicate any wire disconnection, short circuit and serial communication errors.
- Warning by buzzer sound when the warning display is on (buzzer sound can be turned on / off).
- Peak value and warning value during driving are stored. Driving data can be stored and replayed up to 3 minutes.
- Mounting kits are provided with gauges and displays.
- With both fuel pressure and turbo sensors installed, differential pressure can be monitored on the fuel pressure gauge or ADVANCE ZD.

3 List of Products

Product name	Product No.
Defi-Link ADVANCE Control Unit	DF07701

■ ADVANCE CR gauges Φ 52 series

Product name	Display range	White Dial	Black Dial
Turbo2.0	-100kPa ~ +200kPa	DF07801	DF07802
Turbo1.2	-100kPa ~ +120kPa	DF07901	DF07902
In-Mani Press ※	-100kPa ~ +20kPa	DF08001	DF08002
Oil Press	0 ~ 1000kPa	DF08101	DF08102
Fuel Press	0 ~ 600kPa	DF08201	DF08202
Oil Temp	50 ~ 150°C	DF08301	DF08302
Water Temp	20 ~ 120°C	DF08401	DF08402
Exhaust Temp	200 ~ 1100°C	DF08501	DF08502

■ ADVANCE CR gauges Φ 60 series

Product name	Display range	White Dial	Black Dial
Turbo2.0	-100kPa ~ +200kPa	DF08601	DF08602
Turbo1.2	-100kPa ~ +120kPa	DF08701	DF08702
In-Mani Press ※	-100kPa ~ +20kPa	DF08801	DF08802
Oil Press	0 ~ 1000kPa	DF08901	DF08902
Fuel Press	0 ~ 600kPa	DF09001	DF09002
Oil Temp	50 ~ 150°C	DF09101	DF09102
Water Temp	20 ~ 120°C	DF09201	DF09202
Exhaust Temp	200 ~ 1100°C	DF09301	DF09302
Tachometer	0 ~ 9000rpm	DF09403	DF09404

■ ADVANCE BF gauges Φ 60 series

Product name	Display range	White Model	Amber Red Model	Blue Model
Turbo2.0	-100kPa ~ +200kPa	DF09901	DF09902	DF09903
Turbo1.2	-100kPa ~ +120kPa	DF10001	DF10002	DF10003
In-Mani Press ※	-100kPa ~ +20kPa	DF10101	DF10102	DF10103
Oil Press	0 ~ 1000kPa	DF10201	DF10202	DF10203
Fuel Press	0 ~ 600kPa	DF10301	DF10302	DF10303
Oil Temp	50 ~ 150°C	DF10401	DF10402	DF10403
Water Temp	20 ~ 120°C	DF10501	DF10502	DF10503
Exhaust Temp	200 ~ 1100°C	DF10601	DF10602	DF10603
Tachometer	0 ~ 9000rpm	DF10704	DF10705	DF10706

Product Name	Product No.
Defi-Link Meter ADVANCE ZD	DF09701

△ This product is a required for ADVANCE gauges and displays. This product alone does not operate. Please use this product with gauges or displays listed above. As for installation and operation, please refer to the manual for gauges and displays as well.

※ In-Mani Press is an abbreviation of Intake Manifold Pressure.

4 Specification

■ Power supply voltage 10V ~ 16V DC(For 12V vehicle)

■ Current Consumption

Maximum value in case 7 gauges or displays are connected

+B line	2A(IGN ON)
	5mA(IGN OFF)
ILM line	800mA

■ Illumination color Control Unit DC Source LED : blue.
Switch unit : white (while illumination is on)
Switch unit D mark for differential pressure : blue

■ Applicable number of cylinders 1·2·3·4·5·6·8 (4cycle)

■ Temperature range(Under 80% relative humidity) Unit: °C (°F)

	Storage	Operational
CR/BF/ZD	- 40(40) ~ + 80(176)	- 20(4) ~ + 60(140)
ADVANCE Control Unit	- 40(40) ~ + 80(176)	- 20(4) ~ + 60(140)
Switch Unit	- 40(40) ~ + 80(176)	- 20(4) ~ + 60(140)
Boost sensor	- 40(40) ~ + 100(212)	
Press. sensor	- 40(40) ~ + 130(266)	
Temp. sensor	- 40(40) ~ + 150(302)	
Exhaust Temp. sensor	- 40(40) ~ + 130(266)	

(Except the sensing part)

5 Parts List/Part Names/Dimensions

5-1. Parts List

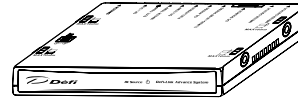

ADVANCE Control unit 1pc



Switch unit
Wire 1.5m(5ft) 1pc

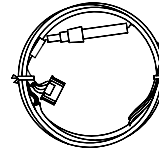

Power source wire
1m(3 1/3ft.) 1pc

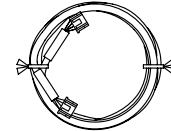

Meter wire
2m(6 3/5ft.) 1pc

Accessories



Double sided tape
1pc



Tie wrap 2pcs



Solderless connector
4pcs



Clip 1pc



Nut 4pcs



Bolt 4pcs

△ Operation manual (this booklet) and warranty card are included with the parts listed above.

5 -2. Part Names & Dimensions of Control Unit in mm(inches)

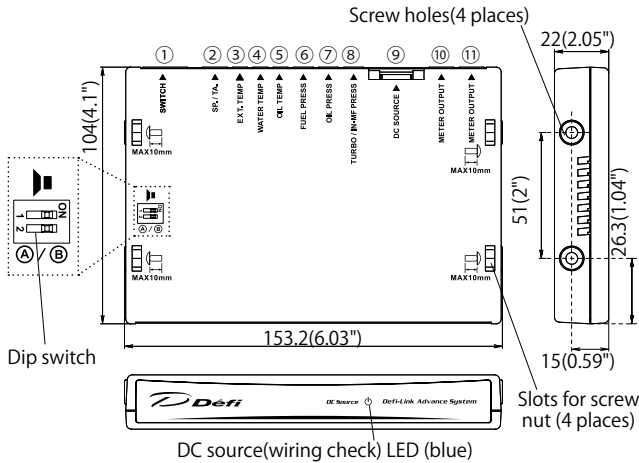

● Connectors for wires

- ① Switch unit(white)
- ② Speed&Tachometer signal wire(blue)
- ③ Exhaust temp sensor wire(black)
- ④ Water temp sensor wire(pink)
- ⑤ Oil temp sensor wire(red)
- ⑥ Fuel press sensor wire(red)
- ⑦ Oil press sensor wire(white)
- ⑧ Turbo/In-Mani sensor wire(light blue)
- ⑨ Power source wire(beige)
- ⑩ Meter wire(white) ⑪ Meter wire(white)

● Dip switch 1&2

- 1: Warning buzzer sounds ON/OFF change
- 2: Opening · Closing modes selection(A/B)

△ Meter wires can be connected to both ⑩ and ⑪ . To protect against short-circuit between two terminals, the convex connector is inserted into the concave connector ⑪ at the factory prior to shipment. If You don't use ⑪ , do not remove the convex connector. When using ⑪ , please pull out the convex connector by pressing the lock, and then connect the meter wire.

5 -3. Part Names & Dimensions of Switch unit in mm(inches)

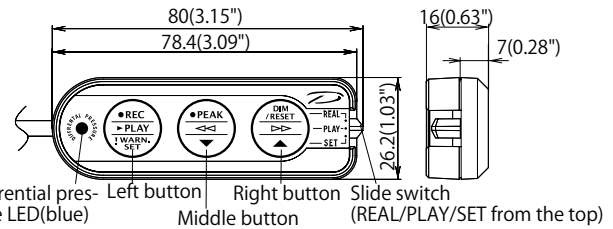

● Backside of switch unit

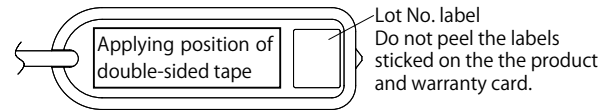

● Buttons and slide switch

Operation of gauges is handled by 3 buttons and 1 slide switch. By sliding the switch position, the functions of buttons change.

● Slide switch

In this manual, positions of the slide switch are illustrated as follows:

REAL(upper): for Real mode operation

PLAY(middle): for operation to replay recorded data

SET(lower): for operation to set up



● Buttons

Each button has three marks(upper, middle, and lower position) in accordance with positions of slide switch. In this manual, each button is illustrated as follows:



Left button : **L** ● REC or **L** ▶ PLAY or **L** ! WARN., SET from the top

Middle button : **M** ● PEAK or **M** ◀◀ or **M** ▼ from the top

Right button : **R** ● DIM/RESET or **R** ▶▶ or **R** ▲ from the top

6 Installation

Confirmation

- 1 Please refer to how to install gauges, displays, and sensors of each manual as well as this manual.

6 -1. Installation diagram

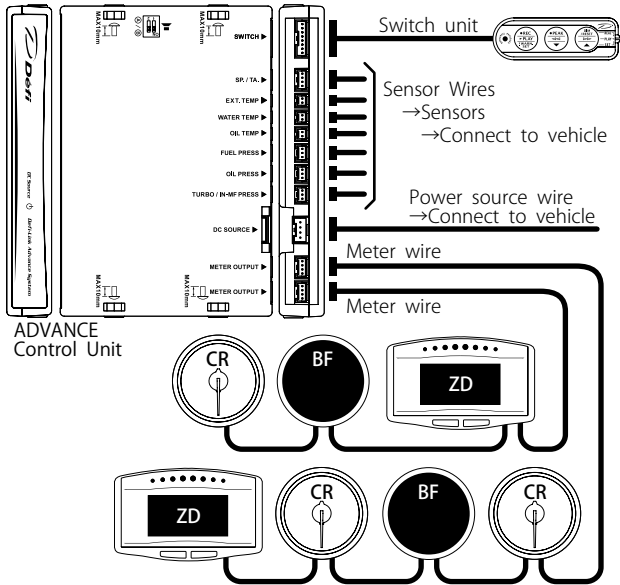

The meter wire can be connected to both two connectors of METER OUTPUT. Up to 7 gauges and displays in all can be connected to one control unit. (Ex. If 7 gauges are connected to one line, none can be connected to the other line. If three gauges are connected to one line, up to 4 gauges can be connected to the other line.)

- 2 Do not connect more than one gauge of the same variety. (Ex. You can NOT connect 2 turbo gauges together.) However, several ZDs can be connected.

6 -2. Procedure

1. Confirm the contents.
 - Please refer to operation manuals included with components and each gauge.
2. Confirm and prepare the necessary parts for installation.
 - Refer to the operation manual included with each gauge.
 - 1 Please purchase commercially available attachment parts.
3. Confirm the location of the power source (Battery, GND, IGN, ILM) and the sensor installation.
4. Disconnect the negative(-) battery terminal.
5. Connect the power supply wire to vehicle.
 - Refer to 6 -3. How to solder • How to use the solderless connectors.

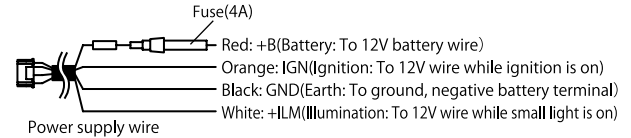

Warning

- 1 Do not connect the IGN wire to the ACC (power source for accessory) wire. Failure to do so may lead to a malfunction or accident.

6. Connect the power supply wire to the control unit. Connect the negative battery terminal and turn the ignition on. Then confirm DC SOURCE LED lights up, which is on the front of the control unit.

Confirmation

- 1 If the power source wire is wired incorrectly, LED won't light. If LED doesn't light, please confirm wiring again.

7. Disconnect the negative battery terminal and install each sensor.
 - Refer to the operation manual included with each gauge.

8. Connect the sensor and the sensor wire. Then connect to the control unit.

9. To confirm the wiring and connection, connect gauges and displays to the control unit temporarily by using meter wires. Do not fix the gauge at this stage.

- ⊗ Do not remove the convex connector if you use only one METER OUTPUT connector to protect against short-circuit between two terminals.

10. Connect the negative battery terminal.

11. Confirm that the DC SOURCE LED is on when the ignition is on. If the power supply wire is wired correctly, the DC SOURCE LED of the control unit lights in blue. And also look see that CR gauges' illumination lights up/BF gauges' illumination darkens/ZD's switch illumination lights up when the illumination switch of the vehicle is on.

- The DC SOURCE LED is not on: The power supply is not taken.
→ Turn the ignition off, then please confirm the wiring of the power supply wire.

- The warning LED of gauge is blinking or the warning LED and peak LED are blinking at the same time: disconnection, short circuit, or communication error is occurred.

⇒ Refer to [7] -3-2. Error displays of wire disconnection, short circuit, and serial error.

- Turn the ignition off, then please confirm the wiring of the sensor and the sensor wire.

Warning

- ⓘ If the wiring defects are not found, it is probable that there is a defect in the product. Please detach the product immediately and ask for inspection. It may damage the vehicle.

⇒ Refer to [10] Maintenance & Check & Servicing.

12. Turn the ignition OFF.

13. Disconnect the meter wire from the gauge, and attach the gauge by using mounting bracket. Confirm it is installed firmly, then connect the meter wire again.

⇒ Refer to each gauge operation manual

14. Connect the switch unit to the control unit and fix the switch unit with double sided tape. Before attaching it, make sure the surface is clean.

⇒ Refer to [5] -3. Part Names & Dimensions of Switch unit in mm(inches).

15. Set 2 dip switches of the control unit.

- Dip switch 1: Setting the buzzer sound ON/OFF.
- Dip switch 2: Select the opening/ending mode from A or B when the ignition is on/off.
⇒ Refer to [5] -2. Part Names of Control Unit in mm(inches), [7] -6-2. Set the warning buzzer ON/OFF, and [7] -2-1. Change of Opening mode / Ending mode.

16. After setting is done, fix the control unit with attached nuts and bolts and commercial mounting bracket.

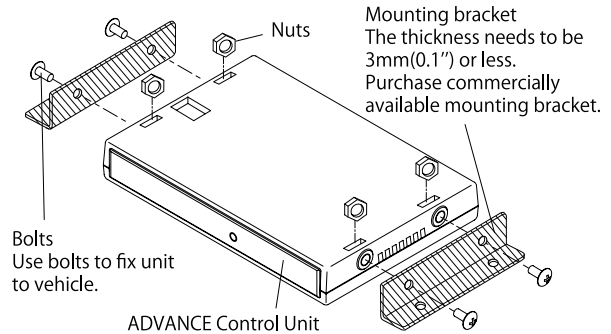

Confirmation

- ⊗ Gauges, including this product, are not waterproof. Please do not install gauges near the vehicle floor or in wet areas.

- ❶ Use mounting brackets with thickness of 3mm(0.1") and under.
- ❷ Do not use other than the supplied bolts. Use of other bolts may damage the inside of the control unit.
- ⚠ The control unit contains buzzer. So it may difficult to hear the sounds if the control unit is installed inside the dashboard or far from driver's seat.
- ❸ It is possible to change the setting later. In order to change later, please fix the control unit so as to operate the dip switch.

17. Final confirmation of install completion

Warning

- ❶ Please be sure to check the following list; otherwise, there is a possibility that a serious accident may occur.
- Ensure that all hoses and tubing are permanently attached. Also ensure that there is no liquid or exhaust leakage.
- Check that the sensor and wires are not interfering with the engine operation.
- Ensure that the gauge and wires are tightly attached, so they don't come loose and hinder driving.
- Check that all wires disconnected from the vehicle during installation have been properly reattached.

Warning

- ❶ After installation, check that no materials or tools remain in the driver's seat or the engine compartment. If there are tools left at the feet of the driver's seat, this may cause a driver to lose control of brake because of tools or materials caught under the brake pedal. If there are tools in the engine compartment, the engine may break.

- Ensure that the negative battery terminal is tightly attached. Close the hood properly.

This concludes the installation process.

Confirmation





- ❶ The protection film is attached to ADVANCE Control Unit and the switch unit. Please peel off before using. It may be stuck by aging of the glue.

⑥ -3. How to solder • How to use the solderless connectors

⚠ Caution

- ❗ Wear protective gloves to avoid getting burned during soldering.
- ❗ Soldering is a better choice for wiring. Make sure no loose connection is found.

● How to solder

- (1) Strip off the outer insulated wire

- (2) Wind to fasten the peeled wire

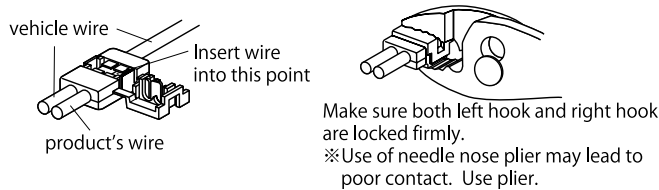
- (3) Solder this part
(Apply an appropriate amount of solder)

- (4) Wrap tightly with insulating tape

● How to use the solderless connectors



Confirmation

- ❗ The solderless connectors that come with the product are for cable core of 0.3mm ~ 0.75mm diameter. Use them within the range.
- ⊘ Do not use the solderless connectors on wires that have thicker cable core than 0.75mm diameter. Cable core might be broken and produce heat.

⑦ Operation

In this instruction, there are two kinds of ways to press buttons, "press" and "press long." For "press," press the button for less than 1 second. For "press long," press the button for more than 1 second.

⑦ -1. Setting and checking of operations

1. Turn the ignition on and check if the DC Source LED on the control unit is lighted up.
⇒ Refer to ⑥ Installation.
2. Confirm that the opening ceremony is done.
⇒ Refer to ⑦ -2. Opening mode / Ending mode.
3. Confirm that there is no error message of wire disconnection/short circuit on the gauges and ZDs.
⇒ Refer to ⑦ -3-2. Error displays of wire disconnection, short circuit, and serial error.
 - ❗ If an error is displayed
→ Turn the ignition off immediately, and then confirm the wiring of the sensor and the sensor wire.
4. If the tachometer is installed, please set the number of cylinders and the response.
 - ⚠ If ZDs are installed as well, settings for tachometer need to be done in System Setup Mode of ZD. The settings of ZD are applied to other tachometers connected to the ADVANCE System. Refer to ZD manual for setting. If you do not install either ZD or tachometer, go to next step.
⇒ Refer to ⑦ -4. Setting number of cylinders mode and ⑦ -5. Setting Tachometer response mode.
5. Set warning values for all the connected gauges and ZDs. And then select illumination color for CR gauges. Warning values for gauges and ZDs are set at the same time.
⇒ Refer to ⑦ -6-3. Change the illumination color.
6. Confirm gauges and ZDs operate normally. Setting is finished by confirming the operations.

⚠ Warning

- ❗ Please set while the vehicle is stopped.

7 -2. Opening mode / Ending mode

When the ignition is turned on, gauges and ZDs performs opening mode. When the ignition is turned off, gauge and ZDs performs ending mode and then the power supplies of the control unit, gauges, and ZDs are shut off.

Confirmation

- △ Depending on vehicles, the ignition is not turned off immediately after the key is turned off. In this case, ending mode doesn't start until the ignition is turned off.
- △ If the ignition is turned off during setting, the setting data will not be saved.
- ❗ If the power wire is wired correctly, the DC Source LED lights in blue from the beginning of opening mode. If it stays off or is blinking, turn the ignition off and check the wiring.
⇒ Refer to 6 Installation.

7 -2-1. Change of Opening mode / Ending mode

Opening and ending modes can be selected from A type (simple) and B type (special) by sliding the dip switch 2 on the control unit.

Both types include features of peak&warning LED, the dialing illumination, lighting/blinking of dial illumination, and sequential indicators of ZD, and so on besides pointer movement and digital display on ZD. Try both types!

- ❗ Please slide the switch when the ignition is off. The modes for all the connected gauges and ZDs are changed at the same time.
- △ It might be hard to see the dial illumination depending on outside light level.

7 -3. Real Mode (slide switch position : **U**REAL)

After the opening mode finishes, the gauge shifts to Real mode. During Real mode, the needle pointer displays the actual vehicle condition in real time.

7 -3-1. Warning display

If the gauge reaches or exceeds the value set for warning, the warning LED goes on. In case of oil pressure and fuel pressure, when the gauge reaches or falls below the value set for warning, the warning LED goes on. The zone that the warning item is displayed is highlighted on ZD display. If the buzzer sound setting is on, the buzzer sounds at the same time as well.

7 -3-2. Error displays of wire disconnection, short circuit, and serial error

If there are disconnection of wire and/or sensor, or short circuits of wire and/or sensor, the warning LED blinks. Error messages are displayed on ZD display. Once the error message is displayed, the warning LED keeps blinking until the ignition is off. Please turn off the ignition immediately and check the wiring of sensors and wires. If the communication between gauges/ZDs and the control unit is failed, serial error message is displayed and warning and Peak LEDs blink at the same time .

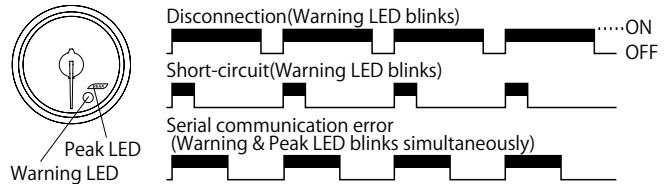

- ❗ If an error is displayed, turn the ignition off immediately, and then confirm the wiring of the sensor and the sensor wire. If any defects are not found, please ask the shop for inspection.

7 -3-3. Illumination

[ADVANCE CR gauges]

The illumination of CR gauges are turned on/off being interlocked with the vehicle illumination switch.

By pressing **R DIM/RESET** button several times during Real mode, Record mode or Playback mode, the gauge illumination is turned off even if the

vehicle illumination is on. (Illumination cancel)

【ADVANCE BF gauges】

The brightness of gauge illumination can be adjusted by pressing

[R DIM/RESET] button during Real mode, Record mode, or Playback mode.

Five levels of brightness are provided for daytime and nighttime separately.

The brightness level is shifted from daytime level to nighttime level being interlocked with the vehicle illumination switch.

By pressing **[R DIM/RESET]** button several times during Real mode, Record mode or Playback mode, the gauge illumination is shifted to the maximum brightness level even if the vehicle illumination is on. (Illumination cancel)

【ADVANCE ZD】

A dimming sensor is equipped with ZD. For brightness adjustment, either AUTO or MANUAL control can be selected. If AUTO is selected, the brightness of ZD display is adjusted automatically depending on the outside light.

By connecting ZDs to the control unit and using AUTO control, the illumination of ADVANCE CR and BF gauges is controlled automatically.

ADVANCE CR: Turned ON/OFF automatically

ADVANCE BF: Adjusted automatically

⑦ -3-4. Differential Pressure Display

If both of the turbo and the fuel pressure gauge are installed (both of the turbo and fuel pressure sensors are installed in case of ZD), the fuel pressure gauge can read the differential pressure value between fuel pressure and intake manifold pressure. During Real mode, the indicator of DIFFERENTIAL PRESSURE on the switch unit is lighted up in blue. The differential pressure can be displayed in Record Mode as well.

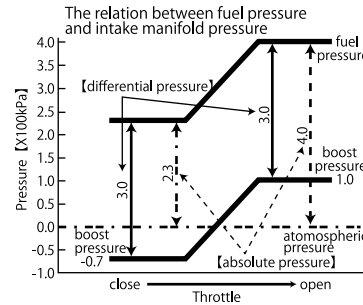

About differential pressure display of fuel pressure; Generally, fuel pressure of electric controlled engine car is controlled to keep in same ratio to intake manifold pressure by fuel pressure regulator. As shown in the graph, fuel pressure meter displaying absolute pressure value indicates 400kPa when boost pressure is 100kPa in case that differential pressure is set at 300kPa. Fuel pressure meter displaying the differential pressure value indicates 300kPa.

1. Set the slide switch to **[U REAL]**.
2. If the **[M OPEAK]** button and **[R DIM/RESET]** button are pressed at the same time, the fuel pressure gauge displays the differential pressure and the indicator of DIFFERENTIAL PRESSURE on the switch unit is lighted up. To cancel, press **[M OPEAK]** button and **[R DIM/RESET]** button together again.

⑦ -4. Setting number of cylinders mode (slide switch position : **[L SET]**)

When the tachometer is installed, please set the number of cylinders.
factory default setting: 4 cylinder

△ If ZDs are installed as well, settings for tachometer need to be done in System Setup Mode of ZD. The settings of ZD are applied to other tachometers connected to the ADVANCE System. Refer to ZD manual for setting.

1. Set the slide switch to **[L SET]**
2. When the **[L ! WARN, SET]** button is pressed long, the gauge shifts to Setting number of cylinders mode, and warning and peak LEDs on the gauge blink alternately.
If ZDs are installed, the system moves into System Setup Mode of ZD not tachometer setting mode. LEDs on the gauge doesn't blink. When the tachometer is not installed, the system does not shift to Setting number of cylinders mode.

- When the **R ▲** button is pressed, the number of cylinders changes into 1 → 2 → 3 → 4 → 5 → 6 → 8. When the **M ▼** button is pressed, the number of cylinders changes into 8 → 6 → 5 → 4 → 3 → 2 → 1. For example, when the number of cylinders 1 is selected, the needle pointer points to 1000rpm when the number of cylinders 4 is selected, the needle pointer points to 4000rpm. Please set the number according to your vehicle.
- After completion of setting, return the slide switch to **U REAL** or **M PLAY**.

7 -5. Setting Tachometer response mode (slide switch position: **L SET**)

If tachometer has been installed, please set the response of Tachometer. You have 3 types to choose from.
factory default setting: Position 1

△ If ZDs are installed as well, settings for tachometer need to be done in System Setup Mode of ZD. The settings of ZD are applied to other tachometers connected to the ADVANCE System. Refer to ZD manual for setting.

By checking needle pointer movement, adjust the response speed of needle pointer.

Position 1	faster	1000rpm
Position 2	middle	2000rpm
Position 3	slower	3000rpm

- Set the slide switch to **L SET**.
- If the **L !WARN,SET** button is pressed long, the gauge shifts to Setting the number of cylinders mode. The peak and warning LEDs on tachometer blink alternately.
If ZDs are installed, the system moves into System Setup Mode of ZD not tachometer setting mode. LEDs on the gauge doesn't blink. When the tachometer is not installed, the system does not shift to Setting numbers of cylinders mode or Setting Tachometer response mode.

- If the **L !WARN,SET** button is pressed long during Setting the number of cylinders mode, the gauge shifts to Setting Tachometer response mode. The peak and warning LEDs in the gauge are lighted up.
- If the **R ▲** button is pressed, the position changes into 1 → 2 → 3. If the **M ▼** button is pressed, the position changes into 3 → 2 → 1. 1000rpm, 2000rpm and 3000rpm indicate Position 1, Position2 and position3 respectively.
- Return the slide switch to **U REAL** or **M PLAY**.

7 -6. Setup mode (slide switch position : **L SET**)

By setting the optional warning value, when the gauge reaches or exceeds the value set for warning, the warning LED on the gauge goes on (in case of oil pressure and fuel pressure, when the gauge reaches or falls below the value set for warning, the warning LED goes on).

If ZDs are installed, warning setting is displayed on ZD display. It is possible to change the illumination color of each gauge. Warning values for gauges and ZDs are set at the same time.

Illumination color for CR gauges can be selected from 2 colors. Illumination color of BF and ZD can not be changed.

■ Warning factory default settings

Gauge	default setting	Unit	Setting range		Lighting condition
			Minimum	Maximum	
Turbo2.0	100	kPa	-100	200	set value and above
Turbo1.2	100	kPa	-100	120	set value and above
In-Mani Press	10	kPa	-100	20	set value and above
Tachometer	7000	rpm	300	9000	set value and above
Oil Press	120	kPa	0	1000	set value and below
Fuel Press	150	kPa	0	600	set value and below
Oil Temp	125	°C	50	150	set value and above
Water Temp	105	°C	20	120	set value and above
Exhaust Temp	850	°C	200	1100	set value and above

7 -6-4. Offset adjustment of Turbo (2.0 and 1.2) and In-Mani Press

The needle pointer of turbo should indicate 0kPa when the ignition is on. But in rare cases the needle pointer is not indicating exactly 0kPa. If this happens, it is possible to offset and adjust the needle pointer.

1. Set the slide switch to **U SET** .
2. If the **L !WARN,SET** button is pressed, the gauge shifts to Setup mode.
3. Select the gauge by pressing **L !WARN,SET** button.
4. Press long **L !WARN,SET** to adjust the gauge. The adjustment is confirmed by a short beep sound.
5. Return the slide switch to **U REAL** or **M PLAY** .

7 -7. Real Peak mode (slide switch position : **U REAL**)

During Real mode, the needle pointer displays the peak value at driving and idling data. The needle pointer displays minimum value as for oil pressure and fuel pressure. The peak value can be reset. It is impossible to display the differential pressure.

1. Set the slide switch to **U REAL** .
2. If the **M OPEAK** button is pressed, the gauge shifts to Real Peak mode. The LED is lighted up during Real Peak mode.
3. If the **M OPEAK** button is pressed, the gauge shifts to Real mode.

7 -8. Real Peak Reset mode (slide switch position : **U REAL**)

It resets the peak value of driving and idling.

1. Set the slide switch to **U REAL** .
2. If the **M OPEAK** button is pressed, the gauge shifts to Real Peak mode. The LED is lighted up during Real Peak mode.
3. If the **R DIM/RESET** button is pressed during Real Peak mode, the LED starts blinking and the peak value is reset. After a reset, the gauge returns to Real mode.

7 -9. Record mode (slide switch position: **U REAL**)

Driving data of each gauge is recorded up to 3 minutes.

1. Set the slide switch to **U REAL** .
2. If the **L OREC** button is pressed, the gauge shifts to Rec mode and start recording. The LED is blinking during Rec mode.
3. If the **L OREC** button is pressed, the gauge finishes recording and returns to Real mode. Also after 3 minutes have passed from recording, the gauge returns to Real mode.

It is possible to turn off the illumination of gauges and to display the differential pressure during Rec mode.

⇒ Refer to 7 -3-3. Illumination and 7 -3-4. Differential Pressure Display.

7 -10. Rec Peak mode (slide switch position: **U REAL**)

During Rec mode, it displays the recorded peak value. The needle pointer displays minimum value as for oil pressure and fuel pressure.

1. If the **M OPEAK** button is pressed during Rec mode, the gauge shifts to Rec Peak mode. The LED is lighted up during Rec Peak mode.
2. If the **M OPEAK** button is pressed again, the gauge returns to Rec mode.

And if the **L OREC** button is pressed, the gauge returns to Real mode.

After 3 minutes have passed from recording, the mode returns to Real mode.

It is impossible to display the differential pressure.

7 -11. Playback mode (slide switch position: **M PLAY**)

Recorded data is played. Pause, single frame step, fast forward and rewind is possible.

1. Set the slide switch to **M PLAY**.
2. If the **L ▶ PLAY** button is pressed, the gauge shifts to Playback mode and play the recorded data. The LED is blinking during Playback mode.
3. When playback finishes or the **L ▶ PLAY** button is pressed during playback, the gauge returns to Real mode.

7 -11-1. Operation during playback

- Playback is paused if the **M ◀◀** button or the **R ▶▶** button is pressed during playback.
 - If the **R ▶▶** button is pressed during pause, playback goes frame by frame. If the **R ▶▶** button is pressed long during pause, it fast forwards playback.
 - If the **M ◀◀** button is pressed during pause, playback is rewind frame by frame. If the **M ◀◀** button is pressed long, during pause, playback is rewind.
 - If the **L ▶ PLAY** button is pressed during pause, playback restarts.
- playback ⇄ pause ⇄ single frame step/single frame rewinding/ fast forward/ rewind

The illumination of gauges can be turned off during Playback mode.
⇒ Refer to 7 -3-3. Illumination.

7 -12. Play Peak mode (slide switch position: **M PLAY**)

During Playback, the peak value of recorded data is displayed. The needle pointer displays minimum value as for oil pressure and fuel pressure.

1. Set the slide switch to **M PLAY**.
2. If the **L ▶ PLAY** button is pressed, the gauge shifts to Playback mode and playbacks the data. The LED is blinking during Playback mode.
3. Set the slide switch to **U REAL** during playback (or pause).
4. If the **M ◉ PEAK** button is pressed during playback (or pause), the gauge displays the peak value of recorded data.
5. If the **M ◉ PEAK** button is pressed again, the gauge returns to playback

the data. To return to Real mode, set the slide switch to **M PLAY** and press long the **L ▶ PLAY** button.

Data playback is ongoing during Play Peak mode.

■ Difference between Real peak, Rec peak, and Play peak

	Real peak	Rec peak	Play peak
Displayed in	Real mode	Record mode	Playback mode
Displayed value	Peak value in all modes	Peak value recorded in Record mode	
Update of peak value	In all modes	During Record mode	
Peak reset	Operatable in Real peak mode	Reset automatically when recording is started	

8 Troubleshooting

⚠ Warning

❗ If any indication of the problem is found in the product, check to make sure the product will operate as expected. Failure to do so can lead to serious accidents.

❗ If any problem is found during using, setting or operating this product, use the following table to confirm proper operation of the unit. If the operational problem is not found in the following table, contact the installation personnel at the store where this product was purchased.

Condition	Possible Cause	Corrective Action
<ul style="list-style-type: none"> ○ Does not operate. ○ Power is not supplied. ○ DC Source LED of the control unit doesn't light. 	<ul style="list-style-type: none"> ○ Wiring of the power supply wire is improper. ○ The fuse of the power supply wire is blown out. ○ The locks of the solderless connectors are not locked tightly. 	<ul style="list-style-type: none"> ○ Check wirings of +B, IGN, GND as per instructions in this manual. ○ Check wiring and replace the fuse. ○ Check the lock of the solderless connectors.
<ul style="list-style-type: none"> ○ DC Source LED of the control unit is blinking. 	<ul style="list-style-type: none"> ○ There is a wire short circuit or disconnected wire somewhere. Maybe there is something wrong on gauge. 	<ul style="list-style-type: none"> ○ Reconfirm the wiring and the gauge according to operation manual. If any defects are not found, please ask the shop for inspection.
<ul style="list-style-type: none"> ○ Warning LED on gauge is blinking 	<ul style="list-style-type: none"> ○ There is a wire short circuit or disconnected wire somewhere on sensor or sensor wire. Maybe there is something wrong between gauge and control unit. 	<ul style="list-style-type: none"> ○ Reconfirm the sensor and sensor wire according to operation manual. If any defects are not found, please ask the shop for inspection.

Condition	Possible Cause	Corrective Action
<ul style="list-style-type: none"> ○ The illumination of CR gauges is not lighted. The illumination of BF gauges is not darkened. 	<ul style="list-style-type: none"> ○ The ILM wiring is improper. ○ The locks of the solderless connectors are not locked tightly. ○ The illumination of gauge is set to off (illumination cancel). ○ The dimmer setting of ZD is AUTO and vehicle is in bright light. 	<ul style="list-style-type: none"> ○ Check wirings of ILM as per instructions in this manual. ○ Check the lock of the solderless connectors. ○ Release illumination cancel function as per instructions in this manual. ○ Change the dimmer setting to MANUAL or move vehicle to a dark place.
<ul style="list-style-type: none"> ○ Does not carry out the ending mode. 	<ul style="list-style-type: none"> ○ The battery wiring is improper. 	<ul style="list-style-type: none"> ○ Check wiring of +B as per instructions in this manual. ○ Check the solderless connector of battery wiring. ○ Ask the store for inspection.
<ul style="list-style-type: none"> ○ The needle pointer is not around right under 0 before starting installation with power off. 	<ul style="list-style-type: none"> ○ The needle pointer moved in transit. 	<ul style="list-style-type: none"> ○ It is the unique feature of stepping motor that the needle pointer may move when a slight impact is made to the gauge with electricity off. Check if the needle pointer goes back to around 0 when the ignition is turned from on to off. If it does not, please contact the store or our customer service center.

Condition	Possible Cause	Corrective Action
<input type="radio"/> The RPM is not displayed correctly.	<input type="radio"/> Wiring of the tachometer signal is wrong. <input type="radio"/> Setting of the number of cylinders is wrong.	<input type="radio"/> Check wiring as per instructions in this manual. <input type="radio"/> Follow tachometer operation manual and wiring instruction for Speed & Tachometer signal wire to confirm the wiring. <input type="radio"/> Check the number of cylinders as per instructions in this manual.
<input type="radio"/> This tachometer is reading slightly lower than the original tachometer.	<input type="radio"/> Generally tachometer readings are about up to 10 % higher than actual RPM.	<input type="radio"/> Check if the difference is up to 10% . This product is designed for high accuracy and should have little error margin. If the difference is much more than 10% , check setting of the number of cylinders.
<input type="radio"/> Serial line error is displayed.	<input type="radio"/> Communication error is occurred between gauges/ZDs and the control unit.	<input type="radio"/> Check the meter wire as per instructions in this manual. If any defects are not found, please ask the shop for inspection.
<input type="radio"/> Serial line errors are displayed on all the connected gauges.	<input type="radio"/> More than one pressure sensors(turbo, oil pressure, and fuel pressure) short-circuit.	<input type="radio"/> In case that the sensor is broken, it need to be changed. please ask the shop for inspection.

9 Repair parts/Optional parts AD:For ADVANCE system exclusive use

Parts Number	Repair Parts Name
PDF07702H	AD Power supply wire (1m, 3 1/3ft)
PDF07707H	AD Meter wire (0.25m, 10in)
PDF07710H	AD Meter wire (2m, 6 3/5ft)
PDF07807G	AD meter cup (52mm, 2 1/16in)
PDF08606G	AD meter cup (60mm, 2 3/8in)
PDF07808G	AD Buffer
PDF07809G	AD Installation parts for meter & ZD
PDF07812G	AD Regular Position Bezel (52mm, 2 1/16in)
PDF08607 G	AD Regular Position Bezel (60mm, 2 3/8in)
PDF06503S	Turbo Sensor
PDF00703S	Pressure Sensor
PDF00903S	Temperature Sensor
PDF01103S	Exhaust Temp. Sensor
PDF01105G	Fitting for Exhaust Temp. Sensor
PDF06505H	Turbo Sensor wire (2.5m, 8 1/5ft)
PDF08105H	AD Oil Press. Sensor wire (3m, 10ft)
PDF06603H	Fuel Press. Sensor wire (2.5m, 8 1/5ft)
PDF05602H	Oil Temp. Sensor wire (3m, 10ft)
PDF05603H	Water Temp. Sensor wire (3m, 10ft)
PDF06803H	Exhaust Temp. Sensor wire (2.5m, 8 1/5ft)
PDF09705H	AD Speed & Tachometer signal wire (2m, 6 3/5ft)
PDF05005G	Fuse (4A) 2pcs

Parts Number	Optional Parts Name
PDF07708H	AD Meter wire (0.5m, 1 3/5ft)
PDF07709H	AD Meter wire (1m, 3 1/3ft)
PDF06002H	Turbo Sensor extension wire (1m, 3 1/3ft)
PDF06013H	Pressure Sensor extension wire (1m, 3 1/3ft)
PDF00707H	Pressure Sensor extension wire (2m, 6 3/5ft)
PDF06014H	Temperature Sensor extension wire (1m, 3 1/3ft)
PDF00906H	Temperature Sensor extension wire (2m, 6 3/5ft)
PDF01107H	Exhaust Temp. Sensor extension wire (2m, 6 3/5ft)
DF09601	ADVANCE Indicator
DF09501	Fitting kit

※ For more information, contact our customer service center, or visit our website.

10 Maintenance & Check/Warranty & Servicing

■ Warranty card • Terms and conditions

This product is delivered with this operation manual and a warranty card. Please read terms and conditions in this manual thoroughly and keep the warranty card in a safe place. Failure to show this warranty will void the warranty.

■ Warranty period

Limited one year warranty. The warranty period starts at the date of retail purchase by the original end-user purchase. Please confirm the warranty card is provided with the information of retail store where purchased. Please refer to Limited Warranty for details.

⚠ Warning

- ❗ Except in the case of defects, we shall not be liable for any trouble including violation, accident or improper wiring resulting from using this product.
- ⊖ The warranty does not cover any unauthorized repair performed or caused to be performed by the end user. Such action can destroy or damage this product.

■ Inspection

Please ask the shop you purchased the product for inspection if any defect in product is suspected. We don't accept the order of fixing because Defi products require installation and wiring to the vehicle.

In case you cannot go to the shop you purchased because of move-out or closure of shop, please ask the nearest Defi Distributor listed in the Defi website.

- ※ For a repair/inspection service, take the warranty card and customer contact information with you.

Customer contact information

Please provide the following information to a store representative when you ask for an inspection.

1. Your contact information		
address, zip code :		
name :		
phone number :		
email address :		
2. Name and address of the store where purchased and installed.		
3. Information about your vehicle		
manufacture and car model :		
model year :		
vehicle type :		
engine type :		
engine displacement :		
transmission (MT/AT) :		
speed limit canceller	with	without
genuine tachometer	with	without
engine swap	with	without
changing ignition device	with	without
changing ECU	with	without
the way to install the sensor :		
other specification :		
4. Your Defi products (including the products that do not need inspection this time)		
5. Describe your experience (when? do what?, what product? what happened? then what?)		

■ Label

The label stuck on the product is for the product traceability. Do not peel it off.

■ Repairing

When a repair is necessary, we will return the inspection result report through the store to you. After receiving a repair service request, we start repairing. Ask the store how much it costs and how long it takes to repair.

■ Discarding the products

Please dispose products in accordance with disposal laws, state laws and local government. A recycle label on the package indicates that the package is recyclable.

Terms and Conditions

LIMITED PRODUCT WARRANTY AND LIMITED PRODUCT LIABILITY

A. Limited Warranty

- a. Our sole obligation to you after the sale of a product is to replace, without charge, the product or any component thereof discovered to be defective within a period of one (1) year from the purchasing date(the "Warranty Period"). You accept sole responsibility for the proper assembly operation and regular maintenance of the product. This limited warranty is void if any product is damaged by accident, misuse, improper installation, or abuse, including tampering or damage in transit. Further, this limited warranty is void if you sell or otherwise transfer a product to a third party, regardless of whether the transfer takes place within the Warranty Period.
- b. Out liability to you resulting from the sale of any product, including liability for any latent defects found within the Warranty Period, shall not exceed the total purchase price paid for the product by you.
- c. YOU UNDERSTAND AND AGREE THAT WE MAKE NO REPRESENTATIONS OR WARRANTIES OF ANY KIND, EXPRESS OR IMPLIED AS TO ANY MATTER WHATSOEVER, INCLUDING THE CONDITION OF THE PRODUCT OR ANY COMPONENT PARTS THEREOF, ITS MERCHANTABILITY OR ITS FITNESS FOR ANY PARTICULAR PURPOSE AND YOU ACCEPT IT, "AS IS," "WHERE IS."
- d. You also understand that we are not granting any express warranties, other than those stated herein. These include only those warranties enumerated in paragraph A. a. There are no other express warranties granted anywhere in these terms and conditions of sale, and you understand and agree to this fact as part of the bargained for exchange of this sale. Nowhere else, except as stated in this paragraph, in this contract is there intended, by either party, for there to be any express warranties granted to you.
- e. EXCEPT AS OTHERWISE PROVIDED HEREIN, WE SHALL NOT BE LIABLE FOR DAMAGES, INCLUDING SPECIAL, INCIDENTAL OR CONSEQUENTIAL DAMAGES WHETHER IN CONTRACT OR IN TORT ARISING OUT OF OR IN CONNECTION WITH THE PERFORMANCE OF ANY PRODUCT OR ANY COMPONENT PART THEREOF OR ITS USE BY YOU, AND WE SHALL NOT BE LIABLE FOR ANY SPECIAL, INCIDENTAL OR CONSEQUENTIAL DAMAGES ARISING OUT OF OR

IN CONNECTION WITH YOUR USE OF THE PRODUCT.

- f. The warranty on this product is void if the product is modified, changed, adjusted or damaged. This product is to be used only in the ways for which it is designed and marketed for, any deviations from the intended uses will void the warranty and will excuse any possible liability of ours.
- g. You accept sole responsibility for the proper assembly, operation and regular maintenance of the product. This limited warranty is void if the product is damaged, changed, altered, or modified by accident, misuse, improper installation, or abuse, including tampering or damage in transit or while in use. YOU HAVE MADE AN INDEPENDENT INVESTIGATION OF THE PURCHASED COMPONENTS AND HAVE RELIED SOLELY ON YOUR OWN INVESTIGATION, BARGAINING AND JUDGMENT IN REFERENCE THERETO. YOU ACKNOWLEDGE THAT YOU ARE NOT RELYING ON OUR SKILL OR JUDGMENT TO SELECT OR FURNISH GOODS SUITABLE FOR ANY PARTICULAR PURPOSE IN PURCHASING OUR PRODUCTS, YOU HAVE NOT RELIED OR ACTED UPON ANY REPRESENTATIONS OR WARRANTIES ON OUR PART NOT SPECIFICALLY SET FORTH HEREIN.
- h. This limited warranty gives you specific legal rights. You may also have other rights which vary from state to state. Some states do not enforce contractual limitations on how long an implied warranty lasts, when an action may be brought, or the exclusion or limitation of incidental or consequential damages, so the above limitations or exclusions may not apply to you.

B. Modification Strictly Prohibited

You understand and agree that any modification whatsoever, of the product, is strictly prohibited. You also agree not to modify the product in any manner regardless of whether such modification is material or immaterial. You also acknowledge that any modification of the product will void your limited warranty and bar you from any recovery or any remedy in a court of law or equity. Modification is strictly forbidden unless expressly authorized by our prior written approval. You agree not to make any modifications to the product and agree not to use any parts, components, or accessories in connection with the installation and use of the product that are not authorized and approved by us.

C. Indemnity and Release

- a. You understand and agree that many factors beyond our control affect the operational safety of the product, including but not limited to the installation of the product according to the instructions provided with the product.
- b. You also understand and agree that the installation of the product may involve the use of tools, equipment and construction methods which may present safety hazards which are beyond our control. You also understand and agree that the use of some of our products may create hazards and lower your ability to control your vehicle.
- c. You agree, as part of the bargained for exchange, to protect, indemnify, save harmless and release us, our authorized agents, employees, officers, directors and shareholders from and against all liabilities, obligations, claims, damages, penalties, causes of action, costs and expenses, imposed upon or incurred by or asserted against us or any assignees of ours, by you or any third party by reason of the occurrence or existence (or alleged occurrence or existence) of any use, installation, assembly, possession or operation of the product, any loss, damage or destruction of the product as of and after delivery (a "casualty occurrence"), and any other act or event relating to or caused by the product, including but not limited to, consequential or of the terms and conditions hereof, or any and all liability for property loss or damage, or any and all damage resulting from death or personal injuries, including loss of services which any person may sustain on account of, arising out of, or in connection with any use, maintenance, possession or operation of the product. In the event that any action, suit or proceeding is brought against us or any of our authorized agents, employees, officers, directors or shareholders by reason of any such occurrence, you will, upon our request and at your expense, resist and defend such action, suit or proceeding or cause the same to be resisted and defended by counsel designated and approved by us.

デフィーリンクアドバンス コントロールユニット取扱説明書

■発行 初版 2008 年 12 月 第 2 版 2010 年 5 月

■製造元 日本精機株式会社

■連絡先 日本精機株式会社 Defi お客様相談室

【住所】〒 940-2141 新潟県長岡市藤橋 1-190-1 R&D センター Defi 事業部

【電話番号】(03) 3835-3639 (Japanese only)

【FAX 番号】(03) 3834-8116

【受付時間】9:30 ~ 12:00, 13:00 ~ 17:00 (土・日曜、祭日、当社休日を除く平日)

【Web サイト】<http://www.nippon-seiki.co.jp/defi/>

Defi-Link ADVANCE Control Unit Operation Manual

■ Issue First edition: December, 2008, Second edition: May, 2010

■ manufacturer Nippon Seiki Co., Ltd.

■ Contact Information Nippon Seiki Co., Ltd. Defi Business Division

【Address】190-1 Fujihashi 1-chome, Nagaoka-shi, Niigata 940-2141 JAPAN

【E-mail】defishop@nippon-seiki.co.jp

【URL】<http://www.defi-shop.com/>

PAT No.3019067 PAT No.3019939