



デフィースポーツディスプレイ取扱説明書
Defi Sports Display F Manual

DF15901 DSDF

DF15902 DSDF ADVANCE Control Unit SET

アドバンスコントロールユニットセット

日本国内でご購入の場合は P. 8 から P. 85 をお読みください。

このたびは、当社製品をお買い上げいただきまして、誠にありがとうございます。お客様・取り付け業者様ともに、ご使用前に本書を全て必ずお読みいただき、取り付け後も常にお手元に保管し、正しいお取り扱い方法でご愛用いただけますようお願い申し上げます。

なお、本品の装着に関する事故や弊害につきましては、いかなる場合においても、当社は一切責任を負いかねますので、あらかじめご了承くださいませようお願い申し上げます。

英語の部分は国内では無効です。

本製品をご使用になる前に、USB メモリーを使って本体のアップデートを実施してください。アップデート方法の詳細は Defi の Web サイトをご参照ください。
www.nippon-seiki.co.jp/defi/

English section is from P. 86 to P. 168.

Thank you very much for purchasing our product. Before installing and using the product, please read this manual thoroughly. All sections are for customers and installation personnels. After installation, please keep this manual for future reference.

Defi will not be held responsible for accidents or damages related to installation of this product.

Japanese section is effective only in Japan.

Please update the product by using a USB flash drive before using it. Please refer to the Defi website for the detail of update.
www.defi-shop.com

本書ではDefi Sports Display Fを省略してDSDFと表記しています。
DSDF is an abbreviation for Defi Sports Display F.

1. English contents

1. English contents	4
2. Safety Warning [Please read carefully.]	86
2.1. Before handling	86
2.2. About installation and operation	90
3. Features	93
4. Lineup	94
5. System structure	94
6. Component	95
6.1. Components included in DF15901/DF15902	95
6.2. Components included in DF15902	96
7. Part names and dimensions	98
7.1. DSDF main unit (unit : mm(inches))	98
7.2. Switch unit for DSDF (unit : mm(inches))	100
8. Specifications	100
9. Display items/range	101
10. Installation	103
10.1. Overall procedure	103
10.2. Installation of DSDF main unit	106
10.3. Installation of switch unit for DSDF	107
10.4. Operation check and settings	108
11. Operation	109
11.1. Mode transition	109
11.2. Method of operation	109
12. Display	110
12.1. Opening mode/Ending mode	110
12.2. Meter mode	110
12.2.1. Street mode	112
12.2.2. Circuit mode	115
12.2.3. Gauge mode	115
12.3. Multi Information Display (MID)	116
12.4. Sequential indicator	118
12.5. Side indicator	119

12.6. State indicator	119
13. Functions	120
13.1. About USB flash drive	120
13.1.1. What you can do by connecting a USB flash drive	120
13.1.2. Operation-confirmed USB flash drives	121
13.2. Meter changeover	121
13.3. Peak display	125
13.4. Peak reset	126
13.5. Time measure display	126
13.6. Play display	129
13.7. Warning display	129
13.8. Warm-up display	131
14. Menu mode	131
14.1. Time measure start	133
14.2. Time measure settings	135
14.2.1. Time measure conditions	135
14.2.2. Course select	136
14.2.3. New course create	136
14.3. Data management	138
14.3.1. Log data play	138
14.3.2. Best time of time measure	138
14.3.3. Best lap time	139
14.4. System settings	140
14.4.1. Dimmer	142
14.4.2. Auto time measure	142
14.4.3. Language	142
14.4.4. OBD warning	143
14.4.5. Warning limit for oil press	144
14.4.6. Warning buzzer	144
14.4.7. TURBO/IN-MF. P. scale	145
14.4.8. Tacho scale	145
14.4.9. Inside bar	145
14.4.10. Gear position range	146
14.4.11. Speed settings for gear position	146
14.4.12. OBD speed offset	147
14.4.13. Sequential indicator pattern	148
14.4.14. Sequential indicator step	148

14.4.15. Device for indicator/bar/measure	149
14.4.16. Warm-up	150
14.4.17. Throttle calibration	151
14.4.18. Side indicator	151
14.4.19. Speed unit	152
14.4.20. Press unit	152
14.4.21. Temp unit	152
14.4.22. Time difference	153
14.4.23. Display No.	153
14.4.24. Touch panel mode	154
14.4.25. Setting value reset	154
14.4.26. System update	155
14.5. Trip reset	155
14.6. Display OFF	156
15. ADVANCE setup mode	157
15.1. ADVANCE warning setup	157
15.2. ADVANCE System setup	157
15.2.1. Speed pulse setting [SPEED PULSES]	158
15.2.2. Number of cylinders setting [ENGINE CYLINDERS]	159
15.2.3. Tachometer response setting [TACHO RESPONSE]	159
15.2.4. Dimmer setting [DIMMER]	159
16. Troubleshooting	159
17. Repair parts	161
18. Optional parts	161
19. Warranty/maintenance/servicing	163
20. Paper template	172
20.1. DSDF Main unit	172
20.2. Switch unit for DSDF	176

2. Safety Warning [Please read carefully.]

This product is an additional product for providing information to automobile users about engine conditions and other important factors. When installing and operating this product, be sure to read the cautionary items of this operation manual as well as those given in the operation manual for the vehicle in which this product will be installed. Please obtain a full understanding of the cautionary items and use the product accordingly. In the event that this product (or the vehicle in which it is installed) is lent to or transferred to another person, please be sure this operation manual and the warranty card accompany the product.

In this manual, the degree of hazard arising from actions such as improper operation is separated into the 3 levels "Danger," "Warning," and "Caution." In addition, instructions that must be followed for safe and proper use of this product as well as practices that must be maintained are marked with a "Confirmation" heading. Please read and become familiar with these sections.

⚠ Danger	Indicates a hazard that could cause death or serious personal injury if the product is mishandled.
⚠ Warning	Indicates a possibility of death or serious personal injury if the product is mishandled.
⚠ Caution	Indicates a conceivable source of personal injury or damage to equipment if the product is improperly operated.
Confirmation	Indicates an instruction that must be performed or practice that must be maintained.

Properties for safety warning

⚠	⚠ indicates attention needs to be paid. (Including warnings)
⊘ Prohibited	⊘ indicates restricted actions. (PROHIBITED actions)
ⓘ Must	ⓘ indicates actions that need to be carried out. (MUST actions)

2.1. Before handling

<for installation personnel>

⚠ Danger

⊘ Do not install the product in wet places. It may result in a fire caused by an electrical short circuit.

- ⊙ Keep the wiring away from locations which affect steering, safety and brake systems. Interfering with normal operation of the vehicle can result in an accident or fire.
- ❗ Ensure that the vehicle will remain stationary and turn the power off before installing this product. Failure to do so could result in a fire, and could make the vehicle move during installation.
- ❗ Remove the key from the ignition and disconnect the negative (-) battery terminal prior to installation of this product. Failure to do so could result in a fire caused by an electrical short circuit.
- ❗ Take care not to install this product in a way that interferes with safety equipment such as seat belts and air bag systems or vehicle operation equipment such as engine controls, steering wheel and brake systems. Interference with normal operation of the vehicle can result in an accident or fire.
- ❗ Solder or use a solderless connector for wiring connections and make sure connections are insulated. In areas where there could be tension or sudden impacts on the wiring, safeguard the wiring with corrugated tubing or other shock absorbent material. Accidental shorts can cause fires.
- ❗ While wiring power supply wire, to avoid the risk of electrical shock or fire, be sure to confirm that there is no disconnection or breakage of wire. Poor connection can result in short-circuit, electrical shock, fire, or other hazards.
- ❗ The ignition-switched +12V(IGN) line must be connected to the vehicle's ignition-switched wire with a fuse of 30A or less. High-capacity fuse (more than 30A) will not blowout even with an abnormal current flow and may cause fire.
- ❗ Discontinue use of this product if a blowout of the fuse has occurred. Continued use while the condition exists could result in an accident, fire, or damage to the vehicle.
- ❗ Use the tube fuse of regulated capacity when the fuse of the power source wire is changed. Using a fuse that exceeds regulated capacity may cause fire.
- ❗ Discontinue use of this product if the product doesn't operate or operates improperly. Continued use while the condition exists could result in an accident or damage.

 **Warning**

- ⊙ Do not disassemble or modify this product. Such actions can not only damage or destroy the product but also will void the warranty.



Disassemble/modify

- ⊙ Do not perform installation of this product immediately after the engine has been switched off. The engine and exhaust system are extremely hot

at this time and can cause burns if touched.

- ⊗ Please keep children and infants away from the installation area. Children may swallow small parts or be injured in other ways.
- ⊗ Do not install this product in the area where safety equipment such as air bags are mounted. This may cause more injuries in the event of accident.
- ⊗ Do not install this product in vehicles which are not compatible with the specification of this product.
- ❗ Carefully consider the installation location and driver's operation of the product before installation. Do not install the product where it interrupts driving and the safety devices of vehicle such as air bags. Be sure not to install the unit where it could fall. Improper installation or operation could cause the product to fall and damage the vehicle or cause serious danger by impeding driving.
- ❗ Ensure that the wiring of this product does not have an adverse impact on the other wiring of the vehicle. Incorrect wiring may destroy your ECU, ignition system and other engine management devices. When tapping engine rev or speed signal from the ECU, please make sure to follow the procedure as below:
 1. Make sure that you have connected the power supply wire of the advance control unit.
 2. Confirm that the DC Source LED of the advance control unit is lighted with ignition on.
 3. Remove negative terminal connector from battery and tap engine rev or speed signal from ECU.

⚠ Caution

- ⊗ Do not drop any of the components of this product. It may result in damage to the product.
- ⊗ Do not apply excessive force on switches/terminals. It may result in damage to the product.
- ⊗ Do not use wires other than the provided wires.
- ⊗ Do not place wires near the engine, exhaust pipe or turbine. It may result in damage or fusion of wires.
- ⊗ Do not expose this product to moisture, dust or direct sunlight, or place product directly in front of heat vents.
- ⊗ Do not pull the wires out of connectors forcefully. The connectors may be broken and the wires may be cut. When pulling out the wires, press the lock firmly and unclip the locks of connectors.

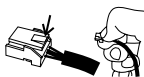

- ⊘ Do not install this product or gauges into the passenger side or center of the dashboard. It doesn't meet vehicle safety standards.
- ⊘ Do not attach wires on the body of the vehicle or engine parts as this may result in damage to the product.
- ❗ This product is designed for use on 12V vehicles. Do not install this product on vehicles with 24V systems.



- ❗ Insulate any unused wires. If any wires or connectors loosen during installation, please make sure they are correctly reattached.
- ❗ Install wires away from ignition and also radio signal frequency interference as this could cause the gauges to malfunction.
- ❗ Please set it up so that the equipment, such as the wireless machines and cellular phones that emit electric waves, does not touch this product. It may result in incorrect operation.
- ❗ Make sure the waterproof processing is done when diverging wires in the engine compartment.
- ❗ When installing the sensor, do not bend the wire near the sensor body.
- ❗ Wear gloves to avoid burns when soldering and cuts when installing wires, sharp edges of parts.
- ❗ Install sensors away from hot or wet places.
- ❗ When using sunshade, put sunshade between products and windshield to avoid direct sun exposure.
- ❗ Turn the power off and use a dried soft cloth for cleanup. Do not use cleaners except neutral detergent. It may damage the product.

Confirmation

- ❗ Be sure to follow all instructions in this manual to ensure safe installation and operation of the product.
- ❗ When the negative (-) battery terminal is disconnected, equipment such as clocks and audio components having internal memory may lose their memory data. Follow the operation manual of each component to reset data after installation of this product.
- ❗ After installation is complete, return this operation manual, warranty card, and the package along with the warranty to the customer .
- ❗ Please confirm with the maintenance book that the car manufacturer issued when installing and detaching genuine parts.
- ❗ Before tapping wires, check the voltage of the existing wire. After tapping the wire, check the voltage of the tapped wire again to confirm whether

you have tapped into the proper place.

- ❗ If car navigation system or car television is installed in vehicle, gauges and wires of this product need to be kept as far away as possible from the wiring and installing positions of car navigation system or car television. Failure to do so may result in interference of television display(VHF).
- ❗ Once this product is fixed, connectors and a USB flash drive may not be mounted/detached easily because all the connectors are located on the backside. Fix this product in consideration of the locations of connectors.
- ⚠ On no event will Nippon Seiki Co., Ltd. be liable to you for any damages or losses of genuine parts for your vehicle while installing.
- ⚠ In the case that your OBDII has a cover, it may not be completely closed by attaching this product to the OBDII connector.

2.2. About installation and operation

<for customer and installation personnel>

Warning

- ⊘ Do not disassemble or modify this product. Such actions will not only void the warranty but also damage or destroy the product.



Disassemble/modify

- ⊘ Do not operate while driving.
- ⊘ Discontinue use of this product if it doesn't operate, water gets into the unit, or smoke or a strange odor comes from the unit. If such a condition occurs, contact the store or installation personnel as soon as possible. Continued use while the condition exists could result in an accident or fire.
- ⊘ Do not use the TIME MEASURE function in open roads. It is only for circuits.
- ❗ Please have this product installed by store professional or dealer where it was purchased. Installation by the customer will void the warranty.
- ❗ In the case any of the warning lamps of vehicle (check engine lamp, etc.) is lighted, stop the vehicle and turn off the engine immediately. After turning off the engine, detach this product from the OBDII connector. Continued use while in a faulty state could result in accidents or malfunction.
- ❗ In order to ensure safe driving, check the information on the gauge only for a short period of time. Looking at the display for a long period of time could distract attention from the road and result in an accident.
- ❗ Fix the switch unit and other parts tightly to the vehicle to avoid that children swallow those.

⚠ Caution

⊘ Do not pull the wires out of connectors forcefully. The connectors may be broken and the wires may be cut. When pulling out the wires, press the lock firmly and unclip the locks of connectors.



⚠ On no event will Nippon Seiki Co., Ltd. be liable to you for any damages arising out of the use or inability to use the product, even if Nippon Seiki Co., Ltd. has been advised of the possibility of such damage.

Confirmation

⊘ This product can be linked to the ADVANCE System NOT to the previous version of Defi-Link System.

❗ The information displayed on this product are for reference purposes only. Please drive according to the indication of vehicle's originally equipped instruments.

❗ This product can be used only on 1, 2, 3, 4, 5, 6, and 8 cylinder vehicles with 4 cycle engine. This product cannot be used on diesel vehicles. Only in case in which vehicles are compatible with the OBD specifications of this product, it can be used on diesel vehicles.

❗ Please check the installed product regularly. Durability might deteriorate according to use conditions, etc.

❗ Detach this product from the vehicle when not in use for a long time.

❗ Dispose of the product according to the local recycling regulations.

❗ Turn the power off before wiping out the touch panel to prevent malfunction.

⚠ This product uses high luminance LEDs. When several gauges are lined up, there might be color difference in the LED production tolerance, but it is not malfunction.

⚠ In the case of idling stop vehicles, the power of the product is turned off and restarted in some cases by a drop in battery voltage when the engine is restarted while idling stop function is active. It is not malfunction.

⚠ The software of this product will be upgraded for product improvement without notice. The contents of this manual and the product may be slightly different.

⚠ The TFT color LCD will be dimmed to prevent damage from heat automatically when heated. It is not malfunction. As the temperature is decreased, the brightness will be increased.

【Regarding a USB flash drive】

- ⊗ Do not turn off the battery while writing data into a USB flash drive. Otherwise, it will be damaged.
- ⊗ Do not pull out/insert a USB flash drive while the ignition is on. Otherwise, the data will be damaged or the drive will not be recognized.
- ❗ Read the instructions of a USB flash drive carefully and use it properly.
- ❗ Before using a USB flash drive, format it in FAT32. A USB flash drive doesn't work properly if it is formatted in other formats.
- ❗ Purchase a commercially available USB flash drive. Some kinds of USB flash drives may not be compatible.
- ❗ Select a USB flash drive in consideration of the installation space. Once this product is fixed, connectors and a USB flash drive may not be mounted/detached easily. Use an USB extension cable such as an angled 90 degree cable with male to female adapter if necessary. Give attention to the direction of the USB connector.
- ⚠ The processing time will slow down due to the increase of the size and number of files.
- ⚠ 200MB and over is necessary in a USB flash drive. Around 40MB is necessary to record the driving log data of 9 hours 59 minutes 59 seconds.
⇒ See section "13.1. About USB flash drive" on page 120.

3. Features

<for customer>

- 4.2 inches touch panel TFT color LCD enhances the operatability and the readability.
- The low-reflection glass cuts down the reflection to the panel surface.
- Accurate location information can be obtained and time can be measured by high performance 10Hz GNSS antenna.
- By using a USB flash drive, driving data can be recorded for a long time (a maximum of 9 hours 59 minutes 59 seconds per file).
※Purchase a commercially available USB flash drive.
- Automatic Dimming control system is equipped.
- The display pattern can be selected from 3 patterns.
- The sensing data can be sent to DSDF from ADVANCE System.
- ISO CAN signals from the OBD connector of your vehicle can be showed.
- Sequential indicator consists of 10 red LEDs for the tachometer warning.
- Side indicator lights up at different colors along with each mode and condition.
- A separate switch unit which is easy to push by fingers with racing gloves is included in the package.
- The latest software program is possible to be downloaded from the Defi website.
- Peak display, warning display, and warm-up functions are equipped.
- Mounting brackets are included and the paper templates are attached.
- The driving log data can be recorded in a USB flash drive and analyzed by a dedicated PC software.

4. Lineup

<for customer>

Part no.	Product name	Summary of contents
DF15901	DSDF (single item)	DSDF, OBD wire, switch, and GNSS antenna
DF15902	DSDF ADVANCE Control Unit Set	DF15901, ADVANCE Control Unit, and sensors

5. System structure

<for customer and installation personnel>

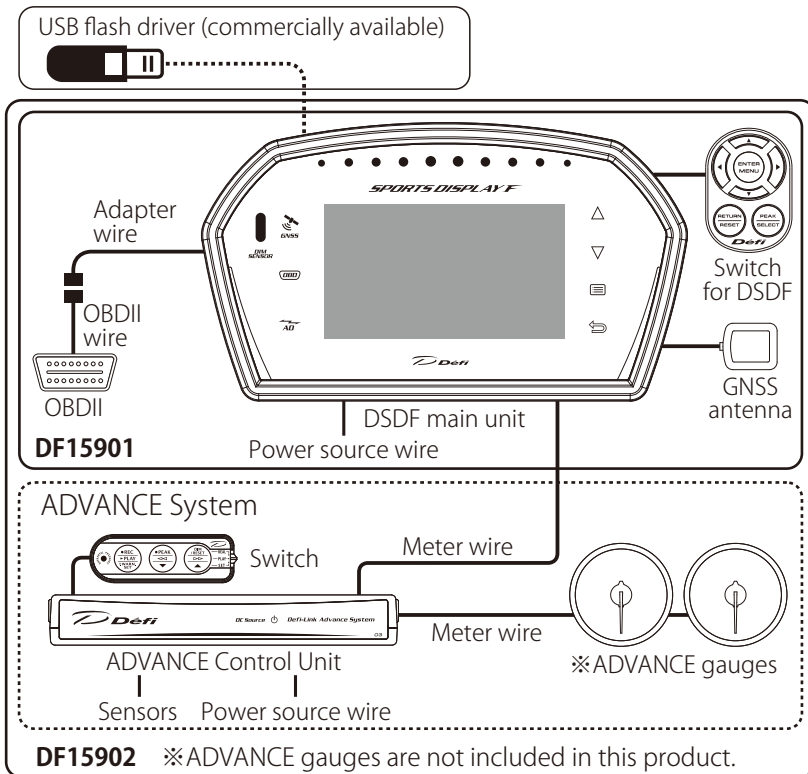

Confirmation







⚠ Connect DSDF to ADVANCE System by using a meter wire. DSDF needs to be connected to the end of the meter line because DSDF has only one connector for a meter wire.

⚠Purchase a commercially available USB flash drive.
 ⇒See section "13.1. About USB flash drive" on page 120.

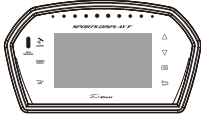
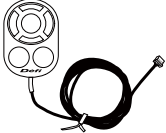
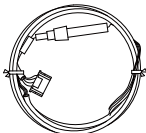
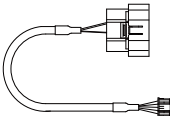
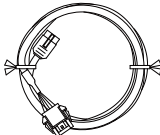
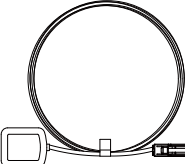
6. Component

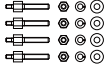
<for customer and installation personnel>

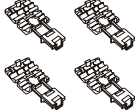
6.1. Components included in DF15901/DF15902







 DSDF main unit 1pc	1.5m (5ft)  Switch unit for DSDF 1pc	1m (3 1/3ft)  Power source wire 1pc
20cm (8in)  OBDII wire 1pc	80cm (2 3/5ft)  Adapter wire 1pc	3m (10ft)  GNSS antenna 1pc
 Plastic band 5pcs	 Mounting bracket 2pcs	 M4 bolt · washer · nut · spring washer 4pcs each
 4×12 tapping screw 2pcs Mounting bracket 1pc for switch mounting	 Solderless connector 4pcs	 Clip 1pc
 Double sided tape 1pc		

Confirmation

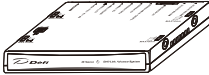
❗ Operation manual (this booklet) and a warranty card are included with the parts listed above. Keep them at hand.

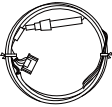
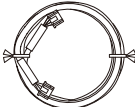
6.2. Components included in DF15902

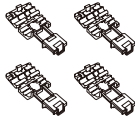

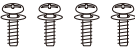



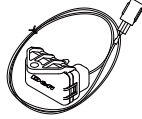
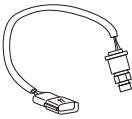
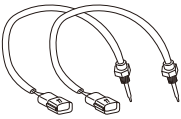

【ADVANCE Control unit package】

 <p>ADVANCE Control unit 1pc</p>	<p>1.5m (5ft)</p>  <p>Switch 1pc</p>	<p>1m (3 1/3ft)</p>  <p>Power source wire 1pc</p>
<p>2m (6 3/5ft)</p>  <p>Meter wire 1pc</p>	 <p>Double sided tape 1pc</p>	 <p>Plastic band 2pcs</p>
 <p>Solderless connector 4pcs</p>	 <p>Clip 1pc</p>	 <p>M4 hexagonal nut 4pcs</p>
 <p>M4 screw 4pcs</p>		

Confirmation

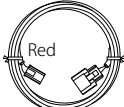
❗ Refer to the manual for ADVANCE Control unit for details.

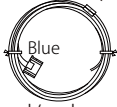
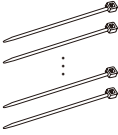
【Sensor package】

 Turbo/boost sensor 1pc	 Pressure sensor 1pc	 Temperature sensor 2pcs
50cm (1 3/5ft)  Rubber hose 1pc	 Three way joining 1pc	2.5m (8 1/5ft)  Turbo sensor wire 1pc
3m (10ft)  Pressure sensor wire 1pc	3m (10ft)  Oil temp sensor wire 1pc	3m (10ft)  Water temp sensor wire 1pc
2m (6 3/5ft)  Speed/tachometer signal wire 1pc	 Plastic band 20pcs	 Solderless connector 1pc

Confirmation

- ❗ Refer to the manual for sensor installation for details.
- ❗ The turbo sensor is for 200kPa (29PSI) or less. In case your boost pressure exceeds 200kPa, purchase the turbo sensor for 300kPa (PDF14604S), a commercially available rubber hose of diameter 4mm and a three way joint .

7. Part names and dimensions

<for customer and installation personnel>

7.1. DSDF main unit (unit : mm(inches))

【前面】

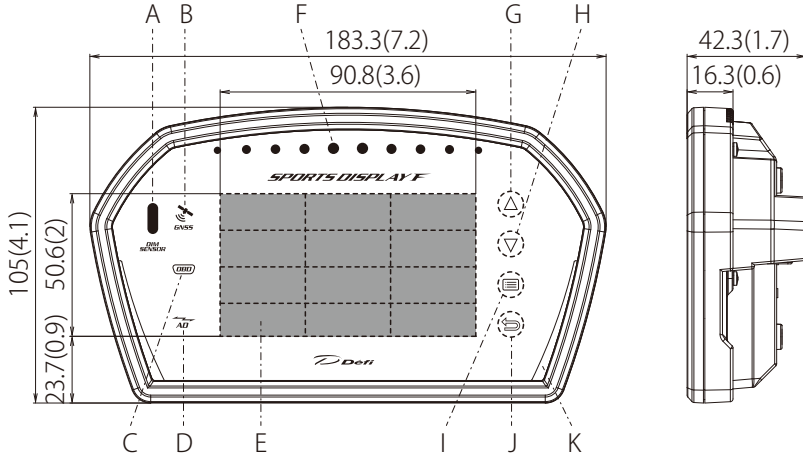

The areas surrounded by dotted lines are touch panel. DSDF has 12 square areas and 4 round areas. Touch central points of each area to operate.

- A: DIM sensor
- B: GNSS indicator
- C: OBD indicator
- D: ADVANCE indicator
- E: LCD panel (touch panel)
- F: Sequential indicator (red 10 LEDs)
- G: UP button (touch panel)
- H: DOWN button (touch panel)
- I: MENU button (touch panel)
- J: RETURN button (touch panel)
- K: Side indicator LEDs (2 places)

【背面】

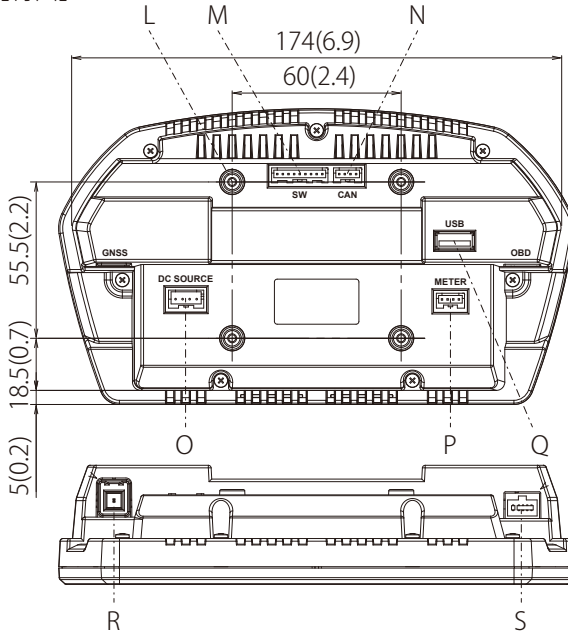

- L: Threaded holes for mounting brackets (4 places)
M: Connector for switch unit for DSDF (white) [SW]
N: Extended connector (black) unused [CAN]
O: Connector for power source wire (beige) [DC SOURCE]
P: Connector for meter wire (white) [METER]
Q: Port for USB flash drive [USB]
R: Connector for GNSS antenna [GNSS]
S: Connector for OBDII wire [OBD]
The letters shown in [] are engraved on the case.

⚠ Caution

- ⊘ Do not remove the convex connector (white) of the extended connector (black). This product doesn't operate if a wrong wire is connected.

Confirmation

🔧 Select a USB flash drive in consideration of the installation space.

Once this product is fixed, connectors and a USB flash drive may not be mounted/detached easily. Use an USB extension cable such as an angled 90 degree cable with male to female adapter if necessary. **Give attention to the direction of the USB connector.**

7.2. Switch unit for DSDF (unit : mm(inches))

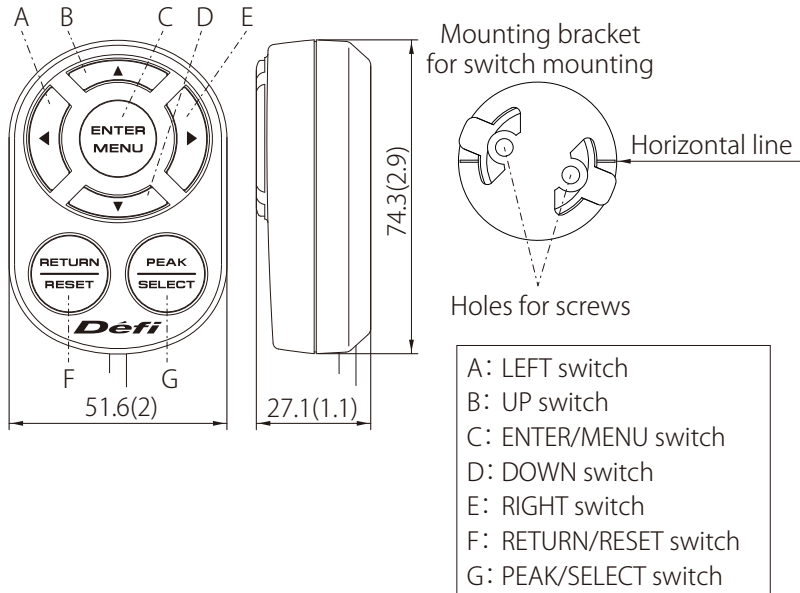

8. Specifications

<for customer and installation personnel>

Storage temperature range	-30°C ~ +80°C, -22°F ~ +176°F
Operation temperature range	-20°C ~ +60°C, -4°F ~ +140°F
Power supply voltage	DC 10~16V
Current consumption	1A (DSDF only), dark current 0.2mA
Applicable speed pulse (When ADVANCE System is connected)	2·4·8·16·pulse free pulse free setting: 1,274~16,562pulse/km (equiv. 2~26 pulse)
Applicable number of cylinders (When ADVANCE System is connected)	1·2·3·4·5·6·8

9. Display items/range

<for customer>

Item	Signal input			SI unit		USDM unit (for USA)	
	A D V A N C E	O B D	G P S	Lower limit ~ Upper limit	unit	Lower limit ~ Upper limit	unit
SPEED	○	○	○	0 ~ 400	km/h	0 ~ 240	MPH
TACHO	○	○	—	0 ~ 11000	RPM	0 ~ 11000	RPM
TURBO	○	○	—	-1.00 ~ 3.00	x100kPa	-30.0 ~ 45.0	inHg-PSI
IN-MF. P.	○	○	—	-1.00 ~ 3.00	x100kPa	-30.0 ~ 45.0	inHg-PSI
OIL P.	○	—	—	0.0 ~ 10.0	x100kPa	0 ~ 145	PSI
FUEL P.	○	—	—	0.0 ~ 6.0	x100kPa	0 ~ 90	PSI
DIFF. P.	○	—	—	0.0 ~ 10.0	x100kPa	0 ~ 145	PSI
OIL T.	○	—	—	0 ~ 150	°C	32 ~ 302	°F
WATER T.	○	○	—	0 ~ 150	°C	32 ~ 302	°F
E.G.T.	○	—	—	0 ~ 1100	°C	400 ~ 2012	°F
VOLT	○	○	—	10.0 ~ 17.0	V	10.0 ~ 17.0	V
THROTTLE	—	○	—	0 ~ 100	%	0 ~ 100	%
IN-AIR T.	—	○	—	0 ~ 100	°C	32 ~ 212	°F
GEAR	○	○	—	0 ~ 9	—	0 ~ 9	—
ODO	○	—	—	0 ~ 999999	km	0 ~ 999999	mile
TRIP	○	—	—	0 ~ 999.9	km	0 ~ 999.9	mile
NOW TIME	—	—	○	0 ~ 9:59.99	—	0 ~ 9:59.99	—
BEST TIME	—	—	○	0 ~ 9:59.99	—	0 ~ 9:59.99	—
LAST1 TIME	—	—	○	0 ~ 9:59.99	—	0 ~ 9:59.99	—
LAST2 TIME	—	—	○	0 ~ 9:59.99	—	0 ~ 9:59.99	—
LAST3 TIME	—	—	○	0 ~ 9:59.99	—	0 ~ 9:59.99	—

- All the items can be displayed in digital.
- Tacho, turbo, and throttle can be displayed as a bar gauge.
- If the signals obtained are more than the upper limits, the upper limit values are displayed. If the signals obtained are less than the lower limits, the lower limit values are displayed.



- GNSS (Global Navigation Satellite System) is a satellite navigation system with global coverage including GPS, GLONASS, Galileo, and so on. The term "GPS" is adopted on the display instead of GNSS.
- To display the ADVANCE items, ADVANCE Control Unit and sensors are necessary. ADVANCE Control Unit and sensors are not included in the package of DF15901.
- 1 turbo sensor, 1 pressure sensor, 2 temperature sensors, and ADVANCE Control Unit is included in the package of DF15902. To display fuel pressure and exhaust temperature, each sensor and sensor wire is necessary additionally.
- If you have already installed the ADVANCE System, it can be connected to DSDF.
- OBD is available on vehicles whose communication specification are compliant with ISO-CAN. Ask our official distributor or your local dealer about the compatibility.

10. Installation

<for installation personnel>

Warning

❗ Please have this product installed by store professional or dealer where it was purchased. Installation by the customer could result in accidents or malfunction.

10.1. Overall procedure

Install ADVANCE Control Unit and sensors before installing DSDF. If you install ADVANCE System and DSDF at the same time.

【Procedure】

- (1) Confirm the components
⇒ See section "6. Component" on page 95.

Confirmation

❗ Dispose of the product packaging materials according to the local recycling regulations.

- (2) Position DSDF and the switch unit for DSDF. Paper templates are available.
⇒ See section "20. Paper template" on page 172.

Confirmation

❗ Once this product is fixed, connectors and a USB flash drive may not be mounted/detached easily because all the connectors are located on the backside. Fix this product in consideration of the locations of connectors.

- (3) Disconnect the negative (-) battery terminal.
- (4) Connect the power source wire to vehicle.
The power source wires for DSDF and ADVANCE Control Unit are the same parts.

If you install only DSDF, use 1 wire. If you install ADVANCE Control Unit with DSDF, use 2 wires.

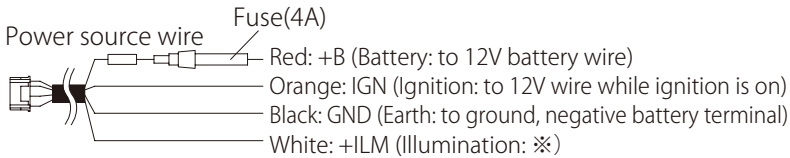

※Regarding the white illumination wire
 For ADVANCE Control Unit: to 12V wire while instrument panel lights are on
 For DSDF: Unused (Insulate it.)

⚠ Caution

❗ DSDF has a dimming function and does not need the white wire for illumination to be wired. Be sure to Insulate it.

Confirmation

⊘ Do not wire the orange wire for ignition to the accessory power source. It may result in malfunction.

(5) **【If you install ADVANCE System in parallel】**
 Attach sensors to vehicle referring to the manuals. And then connect the power source wire for ADVANCE Control Unit, the switch, and sensor wires to ADVANCE Control Unit.

(6) **【If you install ADVANCE System in parallel】**
 Wire the speed/tachometer signal wire to vehicle then to ADVANCE Control Unit. If you will use the speed/tachometer signals from OBDII not from ADVANCE System, the wire is not necessary to be wired.

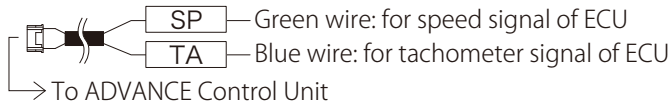

⚠ Caution

❗ If there is an unwired wire, be sure to insulate it.

(7) Locate the GNSS antenna near the vehicle window. Use the magnet of the antenna or double sided tape.

Confirmation

❗ Do not tie the GNSS antenna's wire in a bundle. It may interfere the reception of the signals from satellites.

❗ Locate the GNSS antenna inside the vehicle cabin. If the signal receiving

condition is not good because of heat reflective glass, it's possible to locate the GNSS antenna on the vehicle roof; however, please be aware of pinching of the wire and dropping of the antenna.

- (8) Connect the OBDII wire and the adapter wire. And then connect the wire and the OBD connector of vehicle.

Confirmation

- ❗ The OBDII wire does not need to be connected to vehicle if it is unused.
⚠ In the case that your OBDII has a cover, it may not be completely closed by attaching this product to the OBDII connector.
- (9) Adjust each length of wires and connect the power source wire for DSDF, the GNSS antenna, the OBDII wire, and the switch unit for DSDF.
⇒ See section "7. Part names and dimensions" on page 98.

⚠ Caution

- ⊘ Do not connect any wire to the extended connector (black). This product doesn't operate if a wrong wire is connected.
- (10) Connect DSDF and ADVANCE Control Unit/ADVANCE gauge/ADVANCE display by using the meter wire if you link DSDF and ADVANCE System.
⇒ See section "5. System structure" on page 94.

Confirmation

- ⚠ DSDF needs to be connected to the end of the meter line from "METER OUTPUT" connector of ADVANCE Control Unit if it is connected to ADVANCE gauge/display because DSDF has only one connector for the meter wire.
- (11) Attach a USB flash drive as necessary. Purchase a commercially available USB flash drive.
⇒ See section "13.1. About USB flash drive" on page 120.

Confirmation

- ❗ Select a USB flash drive in consideration of the installation space. Once this product is fixed, connectors and a USB flash drive may not be mounted/detached easily. Use an USB extension cable such as an angled 90 degree cable with male to female adapter if necessary. **Give attention to the direction of the USB connector.**

(12) Fix DSDF and the switch unit for DSDF.

⇒See section "10.2. Installation of DSDF main unit" on page 106.

⇒See section "10.3. Installation of switch unit for DSDF" on page 107.

(13) Connect the negative (-) battery.

(14) Ensure all the parts are fixed and wires are connected. Then go on to the next chapter.

⇒See section "10.4. Operation check and settings" on page 108.

Warning

❗ Carefully consider the installation location and driver's operation of the product before installation. Do not install the product where it interrupts driving and the safety devices of vehicle such as air bags. Be sure not to install the unit where it could fall. Improper installation or operation could cause the product to fall and damage the vehicle or cause serious danger by impeding driving.

❗ Ensure all the parts and wires are tightly attached, so they don't come loose and hinder driving.

❗ After installation, check that no materials or tools remain in the driver's seat or the engine compartment. If there are tools left at the feet of the driver's seat, this may cause a driver to lose control of brake because of tools or materials caught under the brake pedal. If there are tools in the engine compartment, the engine may break.

10.2. Installation of DSDF main unit

Make a mounting panel by using the paper template. And then fix the DSDF main unit with mounting brackets, bolts, washers, spring washers, and nuts.

⇒See section "20. Paper template" on page 172.

Caution

❗ Fix this product and a mounting panel tightly to vehicle with screws, adhesive bond and so on so that it does not come off by impact shock.

❗ Peel off the protection film on DSDF before using.

⚠ The thickness of the mounting panel needs to be more than 2mm.

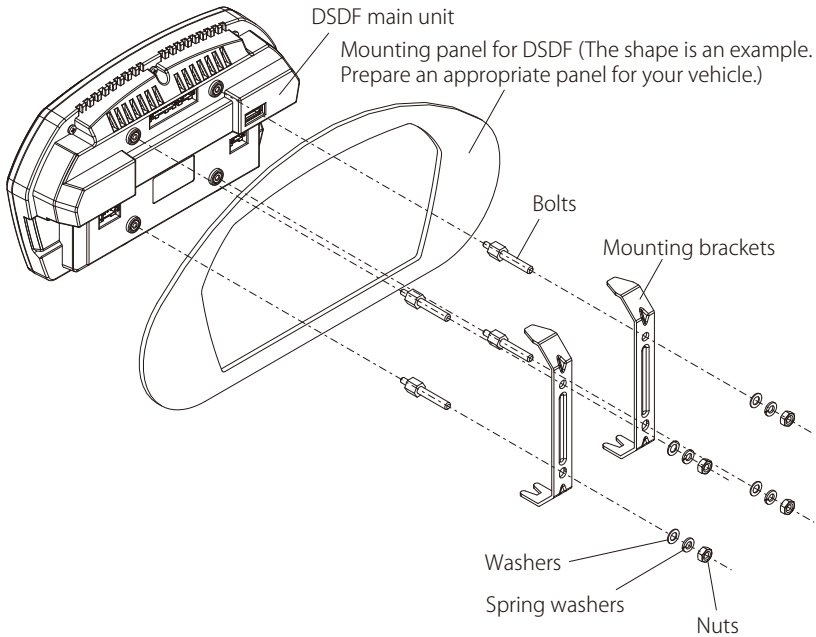

10.3. Installation of switch unit for DSDF

Position the switch unit by using the paper template and fix it with the mounting bracket and tapping screws. Then fit the switch unit into the mounting bracket surely.

⇒ See section "20. Paper template" on page 172.

⚠ Caution

- ⚠ Fix the mounting bracket tightly to vehicle with tapping screws so that it does not come off by impact shock.

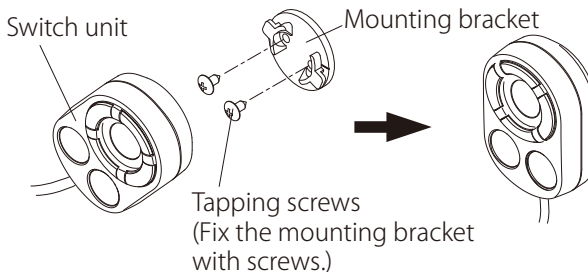

10.4. Operation check and settings

【Procedure】

- (1) **【If you install ADVANCE System in parallel】**
Turn on the ignition and confirm the DC Source LED on ADVANCE Control Unit lights up.
⇒Refer to the manual for ADVANCE Control Unit
- (2) Confirm that the opening mode of DSDF is performed.
⇒See section "12.1. Opening mode/Ending mode" on page 110.
- (3) Confirm that the state indicators light up.
If you use OBD: OBD indicator
If you use ADVANCE: ADVANCE indicator
⇒See section "12.6. State indicator" on page 119.
- (4) Confirm that there is no error message of OPEN/SHORT.
⇒See section "13.7. Warning display" on page 129.
- (5) Change the items displayed if desired. OBD items are set by default.
⇒See section "13.2. Meter changeover" on page 121.
- (6) Configure the system settings for display, units, and so on.
⇒See section "14.4. System settings" on page 140.
- (7) If you install ADVANCE System in parallel, configure the settings for ADVANCE System.
⇒See section "15. ADVANCE setup mode" on page 157.

Confirmation

- ❗ After the system settings are completed, configure other settings as using this product if desired.

11. Operation

<for customer>

11.1. Mode transition

DSDF consists of the following modes.

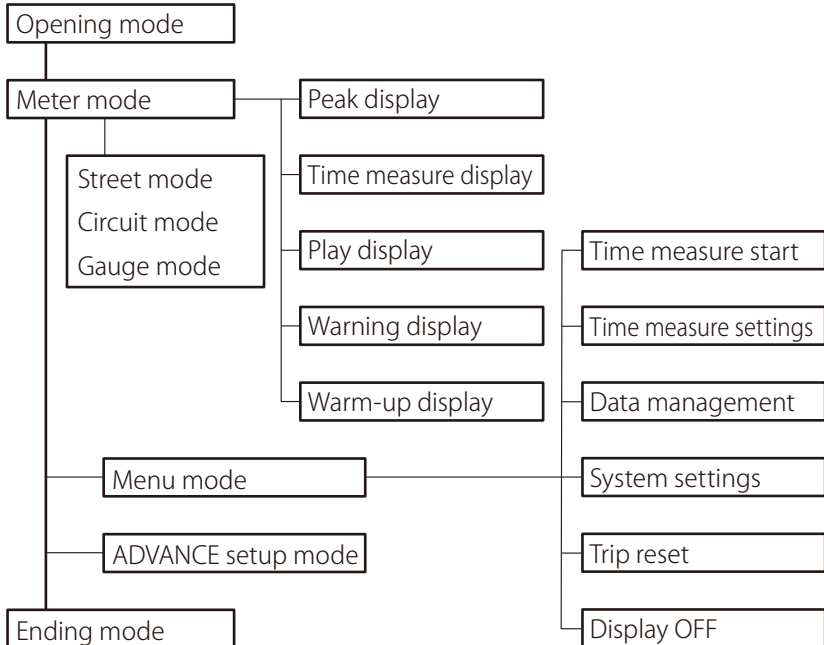

11.2. Method of operation

DSDF can be operated by both the touch panel and the switch unit for DSDF. Use either one depending on your situation.

Operation	Switch unit	Touch panel
Meter mode changeover	DOWN switch (during meter mode)	DOWN button (during meter mode)
Display menu mode	ENTER/MENU switch press and hold	MENU button
Return	RETURN/RESET switch	RETURN button
Display peak values	PEAK/SELECT switch	UP button (during meter mode)
Peak reset	RETURN/RESET switch (during peak display)	RETURN button

12. Display

<for customer>

12.1. Opening mode/Ending mode

DSDF performs Opening mode after the ignition is turned on. DSDF performs Ending mode after the ignition is turned off and the power is turned off in all modes.

Opening mode and Ending mode can be selected from 2 patterns by connecting DSDF to ADVANCE System. To changeover the pattern, slide the dip switch 2 on ADVANCE Control Unit.

⇒Refer to the manual for ADVANCE Control Unit.

Confirmation

⚠ Depending on vehicles, even if you turn off the key, the ignition does not turn off immediately. In that case, the ending mode will not be performed until the vehicle ignition is turned off.

12.2. Meter mode

Meter mode is a main mode of DSDF. Vehicle data is displayed in real time during Meter mode. After Opening mode is performed, DSDF shifts to Meter mode.

DSDF has 3 display patterns in Meter mode: Street mode, Circuit mode, and Gauge mode. Please switch the pattern of your choice.

Confirmation

⚠ Meter mode has 3 different display patterns and each has a name of mode; Circuit mode does not mean for use in circuits.

【Display patterns】



Street mode



Circuit mode



Gauge mode

【How to change the display pattern】

During Meter mode

touch panel	touch DOWN button
switch unit	press DOWN switch

The display patterns switch from Circuit mode to Gauge mode, to Street mode, and to Circuit mode again by rotation.

【Screen composition】

The screen is composed of Main area and Multi Information Display (MID) area.

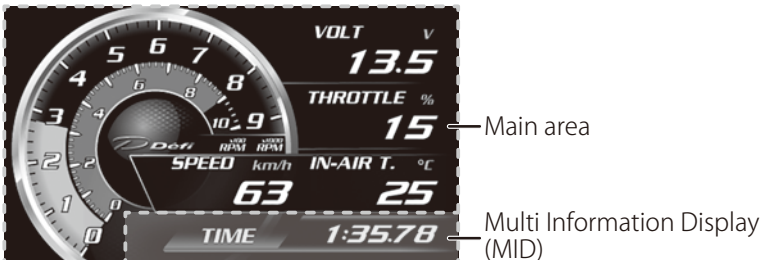



■ Main area

Arbitrarily-chosen items are displayed in each display pattern. Main area is composed of bar gauges and digital gauges. (Gauge mode has only digital gauges.)

■ Multi Information Display (MID) area

MID area is separated from Main area. Various information is displayed at event occurrence.

⇒ See section "12.3. Multi Information Display (MID)" on page 116.

12.2.1. Street mode

2 bar gauges and up to 4 digital gauges are displayed on screen.

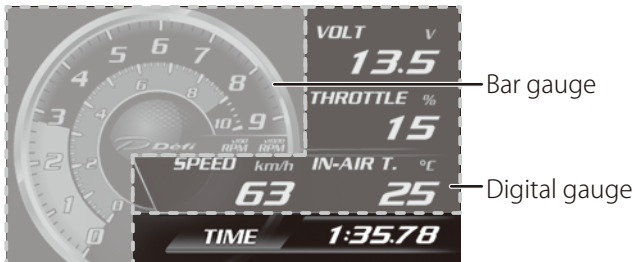

【Bar gauge area】

Bar gauge area is composed of Outside bar and Inside bar.

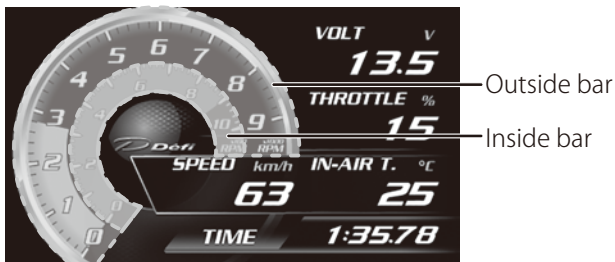

■ How to set

The scale and items of Bar gauge area are set in System settings.

⇒ See section "14.4. System settings" on page 140.

■ Device for obtaining data

Speed and tachometer signals for displaying bar gauge, sequential indicator, and so on can be selected from ADVANCE, OBD, and GPS. Select ADVANCE

or OBD to display tachometer on bar gauge because tachometer signal cannot be obtained from GPS.

Options : ADVANCE / OBD / GPS

Default : OBD

Confirmation

❗ If neither ADVANCE nor OBD is connected to DSDf, select GPS.

⇒ See section "14.4.15. Device for indicator/bar/measure" on page 149.

■ Outside bar

Tachometer signal is displayed on outside bar. The real-time values and the latest peak value are displayed.

The bar colors: gray in normal status, red in warning status, and yellow in precaution status.



⇒ See section "13.7. Warning display" on page 129.

⇒ See section "12.4. Sequential indicator" on page 118.

Outside bar tachometer scale setting (★ default)

Scale	Lower limit~Upper limit	Unit
6000 RPM	0~6000	RPM
8000 RPM	0~8000	
9000 RPM(★)	0~9000	
11000RPM	0~11000	

⇒ See section "14.4.8. Tacho scale" on page 145.

■ Inside bar

Selected item in system settings is displayed on inside bar.

Inside bar item/scale setting (★ default)

Item	SI unit			USDM unit		
	Scale	Lower limit~ Upper limit	Unit	Scale	Lower limit~ Upper limit	Unit
Tacho 1000RPM	0~1000	0~1000	RPM	0~1000	0~1000	RPM
Turbo(★)	20 kPa	-1.0~0.2	x100kPa	3 PSI	-30~3	PSI
	120 kPa	-1.0~1.2		15 PSI	-30~15	
	200 kPa(★)	-1.0~2.0		30 PSI(★)	-30~30	
	300 kPa	-1.0~3.0		45 PSI	-30~45	
Throttle	—	0~100	%	—	0~100	%

Confirmation

❗ If you select turbo as inside bar, choose 300kPa scale when 300kPa sensor is installed. Choose 200kPa or less scale when sensor for 200kPa and under is installed. If unsuitable scale is selected, incorrect values are displayed.

⇒ See section "14.4.7. TURBO/IN-MF. P. scale" on page 145.

⇒ See section "14.4.9. Inside bar" on page 145.

【Digital gauge area】

Digital gauge area is composed of several digital gauges.

The display size can be changed between A-size and B-size. B-size is a size which 2 A-sizes are joined horizontally.

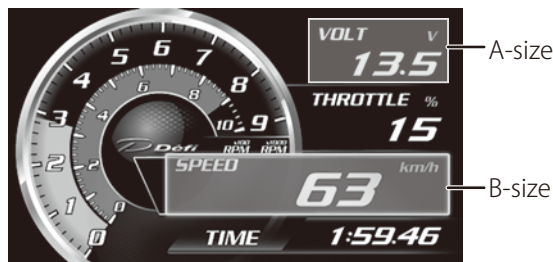

⚠ The function of changing the size from A-size to B-size is not equipped with the product at shipping and will be available by applying the update.

■ How to set

The item for displaying on digital gauge area is set by selecting/touching the area in Meter mode.

⇒ See section "13.2. Meter changeover" on page 121.

■ Display items

⇒ See section "9. Display items/range" on page 101.

12.2.2. Circuit mode

1 bar gauge and up to 4 digital gauges are displayed on screen.



【Bar gauge area】

Bar gauge area is composed of 1 tachometer bar. The device for obtaining data, scales, display colors, and setting methods are the same as outside bar of Street mode.

⇒ See section "12.2.1. Street mode" on page 112.

【Digital gauge area】

Digital gauge area is composed of several digital gauges. The size, display items, and setting methods are the same as Street mode.

⇒ See section "12.2.1. Street mode" on page 112.

12.2.3. Gauge mode

Up to 9 digital gauges are displayed on screen.



【Digital gauge area】

Digital gauge area is composed of several digital gauges. The size, display items, and setting methods are the same as Street mode.

⇒See section "12.2.1. Street mode" on page 112.

12.3. Multi Information Display (MID)

Various information is displayed at event occurrence on the bottom of the panel.

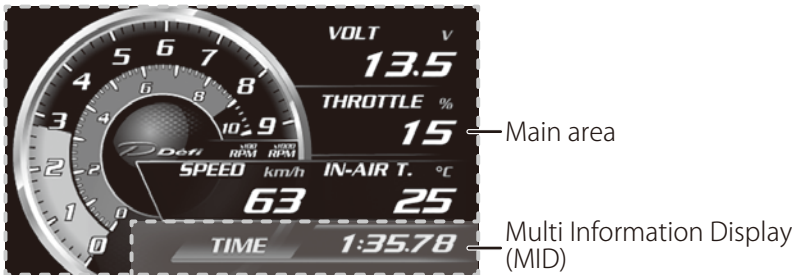

【During normal operation】

■During time measure

[TIME elapsed time] is displayed. **[TIME 0:00.00]** is displayed when time is not measured.

Display range : 00:00.00 ~59:59.99



⇒See section "13.5. Time measure display" on page 126.

■When best record is updated

[RECORD best record] is displayed when best record is updated.



⇒See section "13.5. Time measure display" on page 126.

⚠The function of best record display is not equipped with the product at shipping and will be available by applying the update.

【When operated】

Each information is displayed when DSDF is operated to show peak values and log data.

■While showing peak values

[PEAK HIGH] or **[PEAK LOW]** is displayed in MID area and peak values are displayed in Main area.

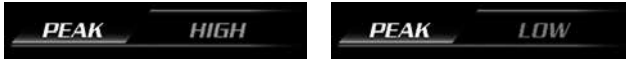

⇒See section "13.3. Peak display" on page 125.

■When peak values are reset

[PEAK RESET] is displayed for one second and peak values are reset by touching the RETURN button or pressing the RETURN/RESET switch while showing peak values.



⇒See section "13.4. Peak reset" on page 126.

■While playing log data

[PLAY elapsed time] is displayed in MID area and log data are played in Main area.

Display range : 00:00.00 ~59:59.90



⇒See section "13.6. Play display" on page 129.

【At event occurrence】

■During warning condition

Numerical values of item in warning condition are displayed in red when the item is not displayed in Main area. When several items are in warning condition, the displayed item in MID area switches every 2 seconds. **[OPEN]** or **[SHORT]** is displayed at occurrence of an error of sensor or wiring.



⇒See section "13.7. Warning display" on page 129.

■During warm-up mode

Numerical values of item in warm-up condition are displayed in blue when the item is not displayed in Main area.



⇒See section "13.8. Warm-up display" on page 131.

■At occurrence of a USB error

[USB ERROR] is displayed when the USB flash drive has any trouble or is short on amount of space while data is written.



⇒See section "13.1. About USB flash drive" on page 120.

【Active display notice】

All of the digital displays linked to ADVANCE System including DSDF need to have "Display No." In addition, one of the digital displays needs to be set as an active display. When one DSDF is linked to ADVANCE System with no other digital displays, the DSDF is set as an active display automatically. The illumination of the whole ADVANCE System is controlled by using the dim sensor of the active display.

⇒See section "14.4.23. Display No." on page 153.

[ACTIVE] is displayed for 2 seconds in MID area after opening mode is performed if DSDF is set as an active display. When several digital displays are linked to ADVANCE System, **[ACTIVE]** is displayed for 2 seconds in MID area when the DSDF is selected as an active display.



12.4. Sequential indicator

10 red LEDs light up or blink depending on tachometer signals and the setting.

All the LEDs blink at the same time when the tachometer signal exceeds
-118-

the warning set value. In addition, the LEDs light up gradually until the tachometer signal exceeds the warning set value.

⇒ See section "14.4.13. Sequential indicator pattern" on page 148.

⇒ See section "14.4.14. Sequential indicator step" on page 148.

12.5. Side indicator

The LED colors of side indicator changes depending on the mode and vehicle conditions.

Condition/Mode	Color
Meter mode	white
Warning	red
Warm-up	blue
Menu/Setup	green
ADVANCE settings	blue

⇒ See section "14.4.18. Side indicator" on page 151.

12.6. State indicator



【GNSS indicator】

GNSS indicator lights up while receiving GNSS signal.



【OBD indicator】

OBD indicator lights up while receiving signals from OBD.



【ADVANCE indicator】

ADVANCE indicator light up while receiving signals from ADVANCE System.

Confirmation

⚠ GNSS signals cannot be received inside a building and a tunnel.

13. Functions

<for customer>

13.1. About USB flash drive

Record, replay, and analysis become possible by connecting a USB flash drive.

Confirmation

- ⊘ Do not turn off the battery while writing data into a USB flash drive. Otherwise, it will be damaged.
- ⊘ Do not pull out/insert a USB flash drive while the ignition is on. Otherwise, the data will be damaged or the drive will not be recognized.
- ❗ Read the instructions of a USB flash drive carefully and use it properly.
- ❗ Before using a USB flash drive, format it in FAT32. A USB flash drive doesn't work properly if it is formatted in other formats.
- ❗ Purchase a commercially available USB flash drive. Some kinds of USB flash drives may not be compatible.
- ❗ Select a USB flash drive in consideration of the installation space. Once this product is fixed, connectors and a USB flash drive may not be mounted/detached easily. Use an USB extension cable such as an angled 90 degree cable with male to female adapter if necessary. Give attention to the direction of the USB connector.
- ⚠ The processing time will slow down due to the increase of the size and number of files.
- ⚠ 200MB and over is necessary in a USB flash drive. Around 40MB is necessary to record the driving log data of 9 hours 59 minutes 59 seconds.

13.1.1. What you can do by connecting a USB flash drive

- Time measure
- Driving data logging (record)
- Driving data playing (replay)
- DSDF system update
- Driving data analysis by a dedicated PC software
- Peak value recording
- ※ Peak values from ignition ON to OFF will be displayed without a USB flash drive.

13.1.2. Operation-confirmed USB flash drives

- BUFFALO RUF2-JUF8GS (8GB)
- I-O DATA TB-XT8G/B (8GB)
- Verbatim USBE8GVZ1 (8GB)
- imation UFDNFE16GGR (16GB)

※The operation has been confirmed by Defi. The USB flash drives listed above is not all that can be used with DSDF. (As of July, 2017)

13.2. Meter changeover

The display items and sizes in digital gauge area can be changed.

【Procedure】

The display items in digital gauge area can be selected from ADVANCE, OBD, and GPS signals.

⇒See section "9. Display items/range" on page 101.

(1) Show a frame.

During Meter mode

touch panel	touch any of digital gauge areas
switch unit	press ENTER/MENU switch

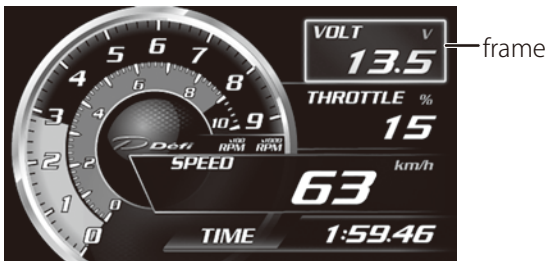

(2) Move the frame to a digital gauge to be changed.

While the frame is shown

touch panel	touch a digital gauge to be changed
switch unit	press any of UP, DOWN, LEFT, and RIGHT switches

(3) Set the gauge to be changed. After setting, the item selection screen appears.



After the frame is moved

touch panel	touch the center position inside the frame
switch unit	press ENTER/MENU switch



(4) Select any of items listed on the item selection screen. There are several pages. Device names and pages are displayed in MID area.



Confirmation

⚠ The selected item is identified by a red check mark, while no check mark is displayed in this manual for the readability.

■ Turning pages

While item selection screen is displayed

touch panel	touch DOWN or UP button
switch unit	press DOWN switch when the frame is positioned at the bottom line or press UP switch when the frame is positioned at the top line

⚠ This operation step for turning pages is the same in every mode.

(5) Set the display item and return to Meter mode.

While item selection screen is displayed

touch panel	touch an item to be displayed
switch unit	move the frame to an item to be displayed and press ENTER/MENU switch

【How to change the size of digital gauges】

The size of digital gauges can be changed between A-size and B-size.

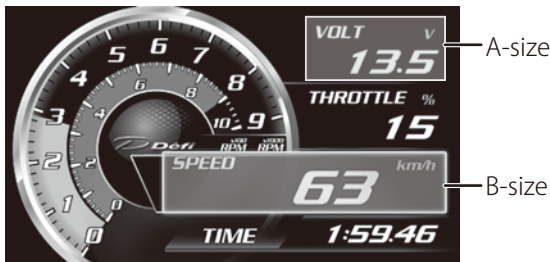

⚠ The function of changing the size from A-size to B-size is not equipped with the product at shipping and will be available by applying the update.

■ Areas which the size can be changed between A-size and B-size

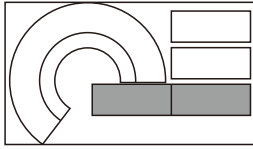

Street mode

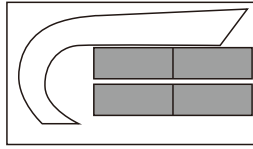

Circuit mode

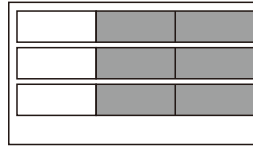

Gauge mode

(1) Show a frame.

During Meter mode

touch panel	touch any of digital gauge areas
switch unit	press ENTER/MENU switch



(2) Move the frame to a digital gauge to be resized. To change from A-size to B-size, select any of center areas. To change from B-size to A-size, select any of rightmost areas.

While the frame is shown

touch panel	touch a digital gauge to be resized
switch unit	press any of UP, DOWN, LEFT, and RIGHT switches

(3) Change the size.

While the frame is shown

touch panel	touch DOWN button
switch unit	press PEAK/SELECT switch



(4) Set the size. After setting, the frame disappears.

While the frame is shown

touch panel	touch RETURN button
switch unit	press RETURN/RESET switch

13.3. Peak display

The maximum (high peak) and the minimum (low peak) values after the last reset of peak values are displayed. Low peak corresponds to oil pressure, fuel pressure, and differential pressure.

- **[PEAK HIGH]** and **[PEAK LOW]** is displayed in MID area.
- Regarding oil pressure, fuel pressure, and differential pressure, high peak and low peak values are displayed by rotation.
- Except for oil pressure, fuel pressure, and differential pressure, high peak values are displayed even during the low peak display.



【How to display peak values】

Each peak value is displayed in the following order:

high peak → low peak → Meter mode

During Meter mode

touch panel	touch UP button
switch unit	press PEAK/SELECT switch

13.4. Peak reset

The high and low peak values of driving and idling including are reset.



【How to reset peak values】

All of the peak values are reset and [—] is displayed in each gauge area. After resetting, **[PEAK RESET]** is displayed for one second in MID area. And then, it goes back to Meter mode.

During Peak mode

touch panel	touch RETURN button
switch unit	press RETURN/RESET switch

13.5. Time measure display

The main functions of time measure is as follows:

- time measuring depending the time measure conditions
- saving log data to a USB flash drive

There are measure conditions of 0-100km/h, 0-400m, courses, and so on. In addition, there is a condition of logging only.

⇒See section "14.2.1. Time measure conditions" on page 135.

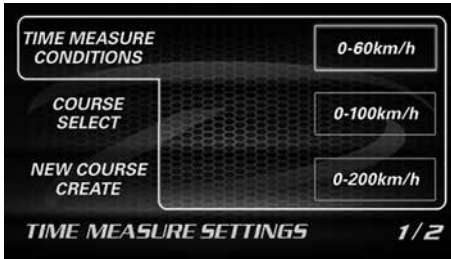

⚠ Warning

⊘ Do not use the time measure function except logging only in open roads. It is only for circuits.

Confirmation

⚠ Vehicle speed values sent from a device set at P:149 "14.4.15. Device for indicator/bar/measure" are used for time measure.

⚠ Purchase a commercially available USB flash drive to use the time measure function. 200MB and over is necessary in a USB flash drive.

⇒ See section "13.1. About USB flash drive" on page 120.

【Folder structure in USB flash drive】

The following folders are created in a USB flash drive automatically by connecting and starting DSDF.

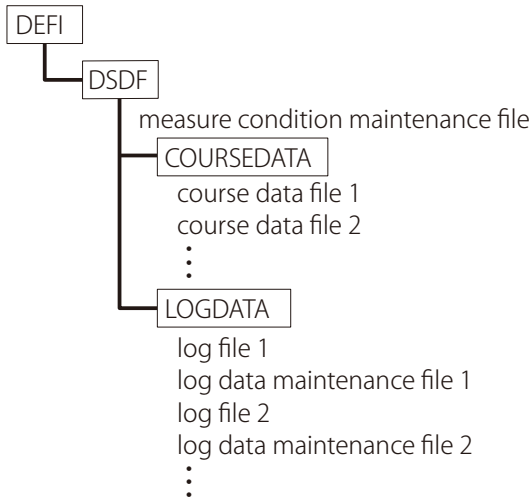

■ DSDF folder

A measure condition maintenance file will be saved in the DSDF folder.

■ COURSE DATA folder

Course data files (measurement line data) will be saved in the COURSEDATA folder.

■ LOGDATA folder

Log files and log data maintenance files are created in the LOGDATA folder by using time measure function. The log files are replayed on DSDF and analyzed by the dedicated software for PCs.

- From start to finish of time measure is saved as one log file.
- A log file name is "year, month, day and time measure start time."
e.g. If time measure starts at 12:34:56 pm, January 1st, 2017:
20170101_123456.dsd
- Data are saved every 0.1 seconds in log files.
- Maximum amount of time of continuous recording is 9 hours 59 minutes 59 seconds 90.
- **[TIME elapsed time(XX:XX.XX)]** is displayed in MID area during time measure.
- Time measure function doesn't start and **[USB ERROR]** is displayed in MID area when a USB flash drive is not connected or when the amount of space is under 200MB.

Confirmation

⊘ Do not edit the maintenance files. It might not work properly. If the maintenance files are deleted or edited by mistake, delete the DEFI folder once and reconnect a USB flash drive to DSDF and start DSDF again to make a new DEFI folder.

13.6. Play display

Saved are replayed on DSDF.

- **[PLAY elapsed time(XX:XX.XX)]** is displayed in MID area during replays.



13.7. Warning display

While each sensor value exceeds the warning setup values (regarding oil pressure and fuel pressure, while each sensor value dips from the warning setup values), warning conditions are indicated. In addition, error messages are displayed when sensors or wires have any trouble such as a short circuit and disconnection if DSDF is connected to ADVANCE System.

■ Side indicator

Side indicators light up in red if the setting for side indicator is ON.

⇒ See section "12.5. Side indicator" on page 119.

■ Buzzer

Warning buzzer sounds if the setting for warning buzzer is ON.

⇒ See section "14.4.6. Warning buzzer" on page 144.

■ LCD panel

Displayed item in Meter mode: Values are displayed in red for minimum 5 seconds.

Non-displayed item in Meter mode: Values are displayed in red in MID area



for minimum 5 seconds.

⇒See section "14.4.4. OBD warning" on page 143.

⇒See section "15.1. ADVANCE warning setup" on page 157.

■Tachometer bar display

Warning range is displayed in red.

⇒See section "12.2.1. Street mode" on page 112.

■Sequential indicator

10 LEDs blink while tachometer exceeds the warning setup value.

⇒See section "12.4. Sequential indicator" on page 118.



【When sensor errors occur】

Displayed item in Meter mode: **[OPEN]** or **[SHORT]** is displayed in the gauge area.

Undisplayed item in Meter mode: **[OPEN]** **[SHORT]** is displayed in MID area.



⚠Caution

❗Turn off the ignition and check the sensors and wires immediately when any error message is displayed. If the cause is not identified, ask for inspection of the store you purchased the product.

13.8. Warm-up display

The warm-up function is available on water temperature and oil temperature. While the actual temperature is lower than the setting value, it is indicated as follows.

■ Side indicator

Side indicators light up in blue if the setting for side indicator is ON.

⇒See section "12.5. Side indicator" on page 119.

■ LCD panel

Displayed item in Meter mode: Values are displayed in blue.

Non-displayed item in Meter mode: Values are displayed in blue in MID area.

⇒See section "14.4.16. Warm-up" on page 150.



14. Menu mode

<for customer>

【Menu items】

Menu	Brief
TIME MEASURE START	Start of time measure and record
TIME MEASURE SETTINGS	Setting of time measure condition such as 0-100km/h, 0-400m, course, and so on.
DATA MANAGEMENT	Replay of log data and management of data
SYSTEM SETTINGS	Setting of units and display
TRIP RESET	Reset of trip meter
DISPLAY OFF	Turning off the touch panel and LEDs

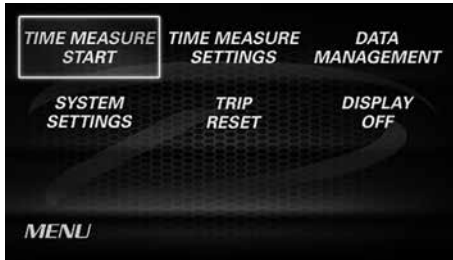

Confirmation

△ The selected item is identified by a red check mark, while no check mark is displayed in this manual for the readability.

【How to enter Menu mode】

During Meter mode

touch panel	touch MENU button
switch unit	hold ENTER/MENU switch down for 1 second

【How to exit Menu mode】

During Menu mode

touch panel	touch RETURN button
switch unit	press RETURN/RESET switch

【How to turn the pages】

When there are several pages

touch panel	touch DOWN or UP button
switch unit	press DOWN switch when the frame is positioned at the bottom line or press UP switch when the frame is positioned at the top line

【How to select or set】

touch panel	touch a desired area on the LCD panel
switch unit	move the frame to a desired area and press ENTER/MENU switch

⇒ See section "11.2. Method of operation" on page 109.

14.1. Time measure start

【How to start time measure】

During Menu mode

touch panel	touch [TIME MEASURE START]
switch unit	move the frame to [TIME MEASURE START] and press ENTER/MENU switch



Confirmation

⚠ Vehicle speed values sent from a device set at P.149 "14.4.15. Device for indicator/bar/measure" are used for time measure.

In addition to the operation described above, time measure starts under the following conditions.

【If AUTO TIME MEASURE is **ON**】

Time measure condition			Start conditions
	km/h	MPH	
①	0-60km/h	0-40MPH	starts recording and measuring when vehicle speed is input after the above operation is done and vehicle is stopped once
②	0-100km/h	0-60MPH	
③	0-200km/h	0-120MPH	
④	0-400m	1/4mile	
⑤	COURSE		close course: starts recording when vehicle speed exceeds 5km/h and starts measuring when vehicle passes the measure line open course: starts recording and measuring when vehicle passes the measure line
⑥	RECORD ONLY		starts recording when vehicle speed exceeds 5km/h

【If AUTO TIME MEASURE is OFF】

Time measure condition			Start conditions
	km/h	MPH	
①	0-60km/h	0-40MPH	starts recording and measuring when vehicle speed is input after the above operation is done and vehicle is stopped once
②	0-100km/h	0-60MPH	
③	0-200km/h	0-120MPH	
④	0-400m	1/4mile	
⑤	COURSE		close course: starts recording when the above operation is done and starts measuring when vehicle passes the measure line open course: starts recording when the above operation is done and starts measuring when vehicle passes the measure line
⑥	RECORD ONLY		starts recording when the above operation is done

⇒See section "13.5. Time measure display" on page 126.

⇒See section "14.4.2. Auto time measure" on page 142.

【How to stop time measure】

During time measure

touch panel	touch RETURN button
switch unit	press RETURN/RESET switch

In addition to the operation above, time measure stops at the following situations:

- when the ignition is turned off
- when the maximum recording time of log data passes
- under the following conditions

Time measure condition			Stop conditions
	km/h	MPH	
①	0-60km/h	0-40MPH	stops when the vehicle speed or distance reaches the selected time measure condition
②	0-100km/h	0-60MPH	
③	0-200km/h	0-120MPH	
④	0-400m	1/4mile	

Time measure condition		Stop conditions
	km/h MPH	
⑤	COURSE	open course: stops when vehicle passes the set line close course: stops only when the above operation is done
⑥	RECORD ONLY	stops only when the above operation is done

⇒See section "13.5. Time measure display" on page 126.

14.2. Time measure settings

"Time measure condition," "course select," and "new course create" are available.

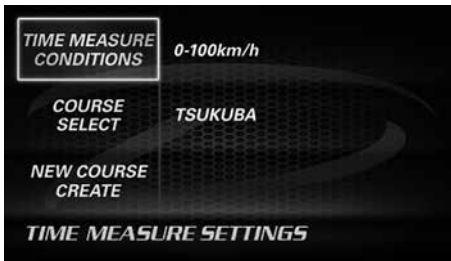

14.2.1. Time measure conditions

Time measure condition can be selected from the following conditions.

Time measure condition		Functions
	km/h MPH	
①	0-60km/h 0-40MPH	measuring the time from vehicle stop state until the vehicle speed reaches the set speed
②	0-100km/h 0-60MPH	
③	0-200km/h 0-120MPH	
④	0-400m 1/4mile	measuring the time from vehicle stop state until the driving distance reaches the set distance
⑤	COURSE	measuring the time by using the selected course lines
⑥	RECORD ONLY	logging without reference to speed, distance, and courses

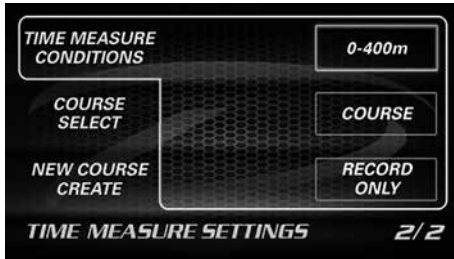
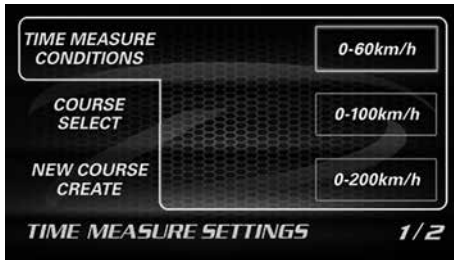

14.2.2. Course select

A course for time measure can be selected from course data in the DSDF folder in a USB flash drive.

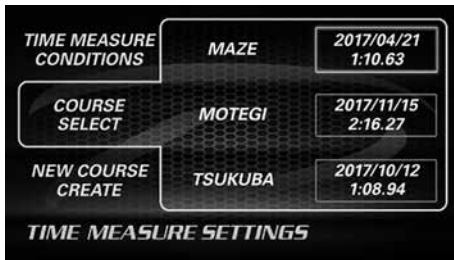

14.2.3. New course create

Measuring lines can be created by using the GPS location signals.

【Procedure】

- (1) Select CLOSE or OPEN.

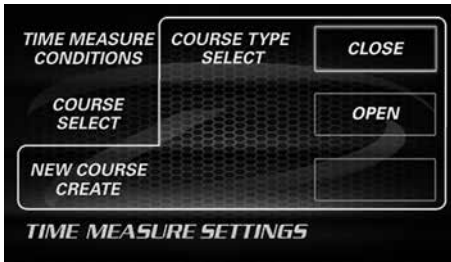

When creating a go-around course, select **[CLOSE]**.

When start and goal positions are different, select **[OPEN]**.

(2) Set a start line in **[OPEN]** mode and a measuring line in **[CLOSE]** mode.

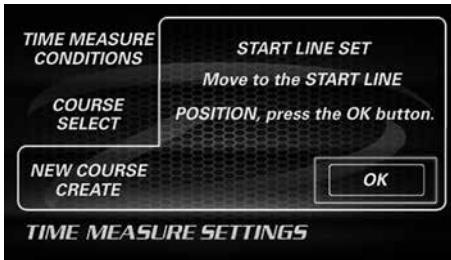

Move vehicle to the line position to be set, and then

touch panel	touch [OK]
switch unit	move the frame to [OK] and press ENTER/MENU switch

If **[CLOSE]** is selected, a course creation is completed.

(3) Set a goal line.



Move vehicle to the goal line position to be set, and then

touch panel	touch [OK]
switch unit	move the frame to [OK] and press ENTER/MENU switch

Created course data are saved in the DSDF folder and named automatically as "course_XXXXXX.txt." "XXXXXX" is a serial number.

14.3. Data management

Log data and time records can be managed.

14.3.1. Log data play

Log data in the LOGDATA folder can be replayed on DSDF.

【How to play data】

While log data are listed in LOG DATA PLAY

touch panel	touch the log file area to be played
switch unit	move the frame to the log file area to be played and press ENTER/MENU switch



【How to stop playing】

While a log file is being played

touch panel	touch RETURN button
switch unit	press RETURN/RESET switch

In addition to the operation described above, playing stops when the file is ended.

⇒See section "13.6. Play display" on page 129.

14.3.2. Best time of time measure

Best records of time measure such as 0-100km/h can be checked and deleted. To delete the record, select the time and touch **[DELETE]** button or press ENTER/MENU switch.

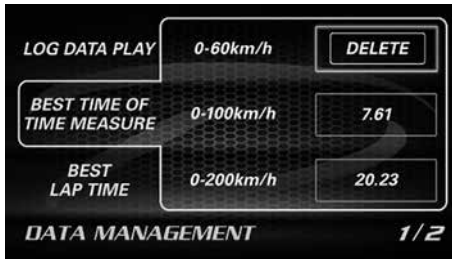
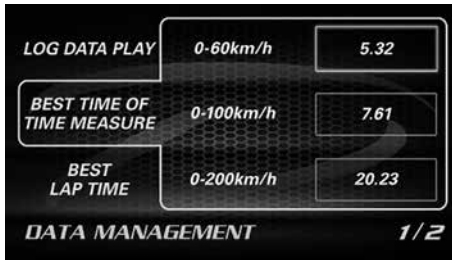

14.3.3. Best lap time

Best records of each course can be checked and deleted. To delete the record, select the time and touch **[DELETE]** button or press ENTER/MENU switch.



14.4. System settings

Various systems can be set.

【Setting items】

Item	Options/contents	Default
DIMMER	FIXED MAX BRIGHTNESS • BRIGHTER • MIDDLE • DARKER	MIDDLE
AUTO TIME MEASURE	ON • OFF	OFF
LANGUAGE	日本語 (JAPANESE) • ENGLISH	日本語 (JAPANESE)
OBD WARNING	TURBO/IN-MF. P. • TACHO • WATER TEMP	100kPa • 7000RPM • 105°C
WARNING LIMIT FOR OIL PRESS	RPM	3000RPM
WARNING BUZZER	ON • OFF	ON
TURBO/IN-MF. P. SCALE	20kPa • 120kPa • 200kPa • 300kPa/ 3PSI • 15PSI • 30PSI • 45PSI	200kPa
TACHO SCALE	6000 • 8000 • 9000 • 11000	9000RPM
INSIDE BAR	TURBO/IN-MF. P. • TACHO1000RPM • THROTTLE	TURBO/IN-MF. P.
GEAR POSITION RANGE	3 ~ 9	5
SPEED SETTINGS FOR GEAR POSITION	1 ~ 9	⇒ See section "14.4.11. Speed settings for gear position" on page 146.
OBD SPEED OFFSET	-10 ~ +10%	+3%
SEQUENTIAL INDICATOR PATTERN	SINGLE • DUAL	SINGLE
SEQUENTIAL INDICATOR STEP	100 • 200 • 250 • 500	200RPM
DEVICE for INDICATOR/BAR/ MEASURE	ADVANCE • OBD • GPS	OBD

Item	Options/contents	Default
WARM UP	OIL TEMP 0 ~ 150°C /32 ~ 302°F • WATER TEMP 0 ~ 150°C /32 ~ 302°F	OIL TEMP 60°C WATER TEMP 40°C
THROTTLE CALIBRATION	FULL CLOSE • FULL THROTTLE • DEFAULT	FULL CLOSE 0% FULL THROTTLE 100%
SIDE INDICATOR	ON • OFF	ON
SPEED UNIT	km/h • MPH	km/h
PRESS UNIT	kPa • PSI	kPa
TEMP UNIT	°C • ° F	°C
TIME DIFFERENCE	HOUR -12 : 00 ~ +12 : 00	+9 : 00
DISPLAY No.	1 ~ 7	---
TOUCH PANEL MODE	NORMAL • HIGH SENS.	NORMAL
SETTING VALUE RESET	RESET	—
SYSTEM UPDATE	Update screen	Ver. 1.0

Confirmation

⚠ There are several pages in system settings. **[SYSTEM SETTINGS page number]** is displayed in the bottom of the screen. Turn pages as necessary.

⇒ See section "11.2. Method of operation" on page 109.

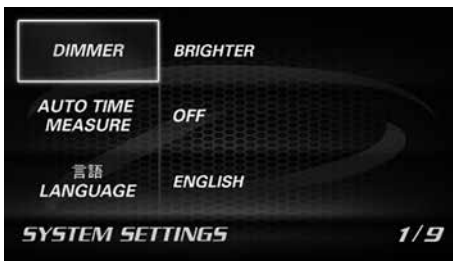

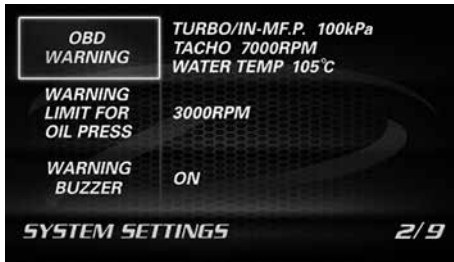

14.4.1. Dimmer

The dimming level can be selected from 4 levels.

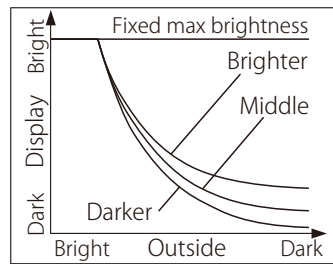
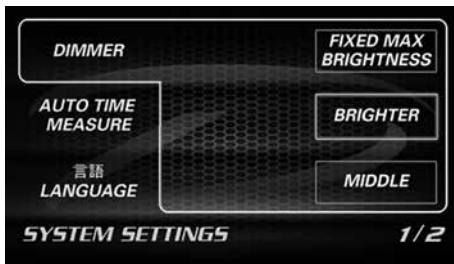

14.4.2. Auto time measure

Time measure starts automatically when auto time measure in ON, a USB flash drive is connected, and the amount of space is over 200MB.

⇒See section "14.1. Time measure start" on page 133.

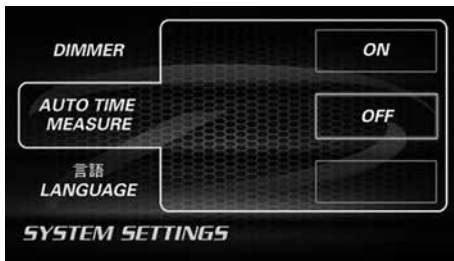

14.4.3. Language

The language can be selected from Japanese (日本語) and English

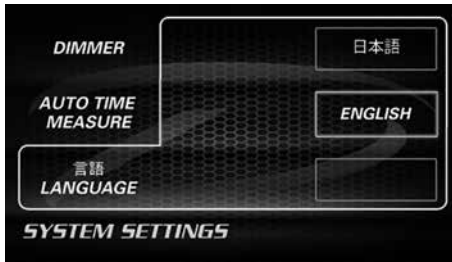

14.4.4. OBD warning

Warning value for OBD items can be set.

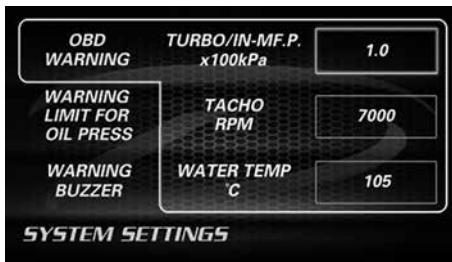

■ Setting range

Item	Value	1 step
TURBO/IN-MF.P.	-100 ~ 155 kPa	10 kPa
	-29.5inHg ~ 22.5 PSI	0.5PSI
TACHO	0 ~ 11000 RPM	50RPM
WATER TEMP	0 ~ 150 °C	1 °C
	32 ~ 302°F	1 °F

【How to change the setting values】

(1) Select an item to change the setting values.

While the item is selected (the color of inside the frame is changed)

touch panel	touch UP or DOWN button
switch unit	press UP or DOWN switch (fast-forward by holding)

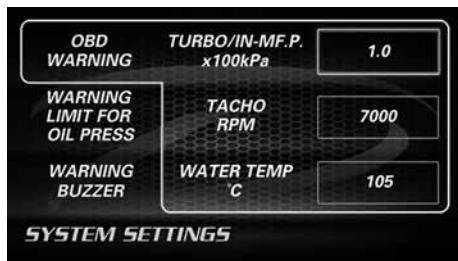

(2) Set a value.

touch panel	touch the selected frame
switch unit	press ENTER/MENU switch

From the following section, operate likewise.

14.4.5. Warning limit for oil press

Warning output can be stopped when the tachometer signal is under the set value.

Confirmation

△ The tachometer signal taken out from the device set at P.149 "14.4.15. Device for indicator/bar/measure" is used. When tachometer signal cannot be taken out from the setting device, it does not function properly.

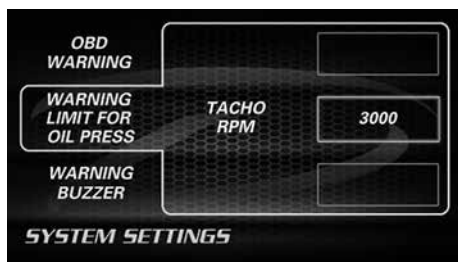

■ Setting range

Item	Value	1 step
TACHO	0 ~11000 RPM	500 RPM

14.4.6. Warning buzzer

The warning buzzer can be turned on/off. Warning buzzer sounds during
-144-

warning conditions if the warning buzzer is ON.

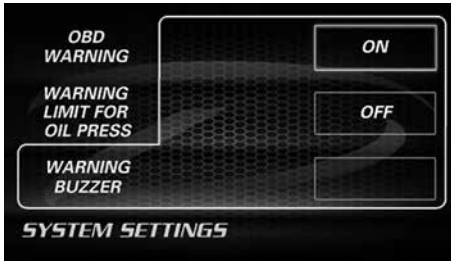

Buzzers except for warning buzzer cannot be turned off.

14.4.7. TURBO/IN-MF. P. scale

The scale of turbo/intake manifold pressure bar display can be set.



14.4.8. Tacho scale

The scale of tachometer bar display can be set.



14.4.9. Inside bar

The item to be displayed as inside bar in Street Mode can be set.



Confirmation

⚠ The signals taken out from the device set at P.149 "14.4.15. Device for indicator/bar/measure" are used. When signals cannot be taken out from the setting device, it does not function properly.

14.4.10. Gear position range

The largest value for gear position can be set, e.g. 5 if vehicle is 5-speed transmission.

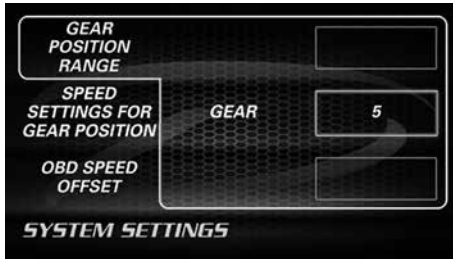

14.4.11. Speed settings for gear position

Speed values at 2000RPM of each gear need to be input to calculate the gear position.

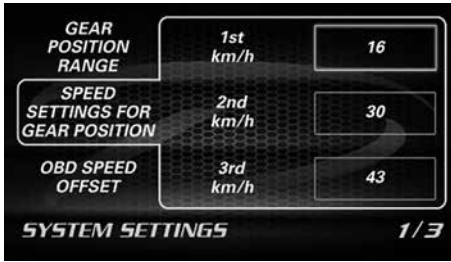

■ Default

Gear position	Speed in km/h	Speed in MPH
1st	16km/h	10MPH
2nd	30km/h	19MPH
3rd	43km/h	27MPH
4th	54km/h	34MPH
5th	67km/h	42MPH
6th	78km/h	48MPH
7th	90km/h	56MPH
8th	100km/h	62MPH
9th	110km/h	68MPH

■ Setting range

Item	Value	1 step
GEAR POSITION 1st~9th	0 ~400 km/h	1km/h
	0~240 MPH	1MPH

Input speed values from 1st to the largest gear position set in gear position range.

14.4.12. OBD speed offset

A correction coefficient for OBD speed signals can be set.

⚠ Most of the genuine speedometers are corrected for safety reasons and doesn't coincide with the OBD speed signals generally. Set the OBD speed offset as necessary.

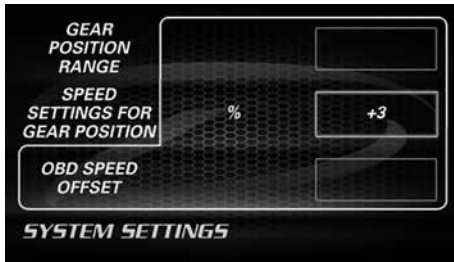

■ Setting range

Item	Value	1 step
OBD SPEED OFFSET	-10 ~ +10%	1%

14.4.13. Sequential indicator pattern

The lighting pattern of sequential indicators can be set.

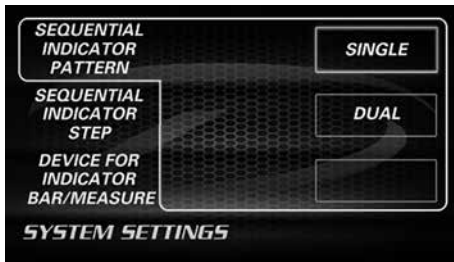

SINGLE : lights up from the left side

SINGLE→



DUAL : lights up from the both sides

DUAL→

←DUAL



Confirmation

⚠ The tachometer signal taken out from the device set at P.149 "14.4.15.

Device for indicator/bar/measure" is used. When tachometer signal cannot be taken out from the setting device, it does not function properly.

14.4.14. Sequential indicator step

The lighting step of sequential indicator LEDs can be selected from 100, 200, 250, and 500RPM. 10 red LEDs light up gradually depending on tachometer signals and this setting. In addition, all the LEDs blink at the same time when

the tachometer signal exceeds the warning set value.

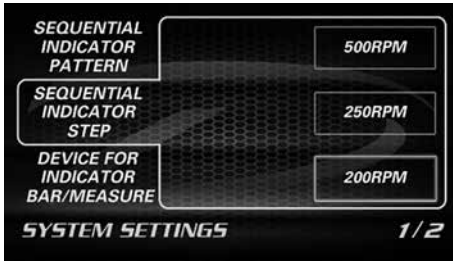

The lighting timing can be calculated by subtracting this step values from warning set value.

Confirmation

⚠ The tachometer signal taken out from the device set at P.149 "14.4.15. Device for indicator/bar/measure" is used. When tachometer signal cannot be taken out from the setting device, it does not function properly.

Example 1: Warning setting 8000RPM + Single pattern + Step 200RPM

8000RPM and over → All LEDs blink
 7800RPM → All LEDs light up
 7600RPM → 9 LEDs from the left side light up
 :
 6000RPM → 1 LED from the left side lights up
 Less than 6000RPM → No LEDs light up

Example 2: Warning setting 8000RPM + Dual pattern + Step 200RPM

8000RPM → All LEDs blink
 7800RPM → All LEDs light up
 7600RPM → 4 LEDs from the right side and 4 LEDs from the left side light up
 :
 7000RPM → 1 LED from the right side and 1 LED from the left side light up
 Less than 7000RPM → No LEDs light up

If OBD is set as "Device for indicator/bar/measure,"
 ⇒ See section "14.4.4. OBD warning" on page 143.

If ADVANCE is set as "Device for indicator/bar/measure,"
 ⇒ See section "15.1. ADVANCE warning setup" on page 157.

14.4.15. Device for indicator/bar/measure

A device to take out speed and tachometer signals needs to be set for the following displays and functions.

- Sequential indicator
- Tachometer bar display of Meter Mode
- Speed signal for time measure
- Tachometer signal for warning limit for oil press

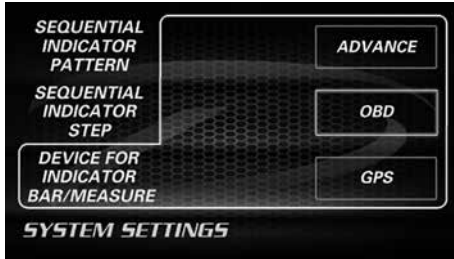

Confirmation

⚠ An unconnected device or a device with no signal input can be selected. It will not function properly if such a device is selected.

14.4.16. Warm-up

Warm-up temperatures can be set. While the actual temperature is lower than the setting value, it is indicated as a warm-up display.

⇒ See section "13.8. Warm-up display" on page 131.

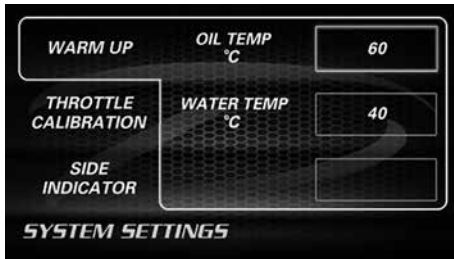

■ Setting range

Item	Value	1 step
OIL TEMP / WATER TEMP	0~150°C	1 °C
	32 ~302 °F	1 °F

14.4.17. Throttle calibration

Calibration values can be applied to throttle valve opening. Characters of throttle valve openings differ depending on vehicles. Throttle valve openings are generally not 0% when the accelerator pedal is released and not 100% when the accelerator pedal is floored.

In this calibration, it is possible to set the throttle valve openings as FULL CLOSE (0%) at the time when the accelerator pedal is released and as FULL THROTTLE (100%) at the time when the accelerator pedal is pushed all the way to the end.

If DEFAULT is selected, raw data from OBD are displayed.

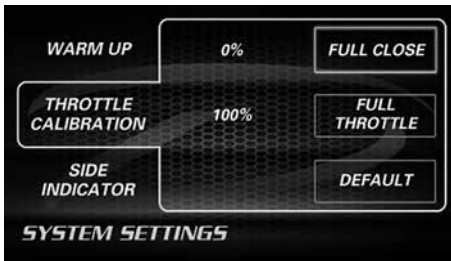

Danger

⊘ Do not turn on the engine when calibration is done. Turn on the ignition only and calibrate while vehicle is stopped.

■ Setting range

Item	Value	1 step
THROTTLE CALIBRATION	0 ~ 100%	1%

14.4.18. Side indicator

Side indicator can be turned on/off.

⇒ See section "12.5. Side indicator" on page 119.

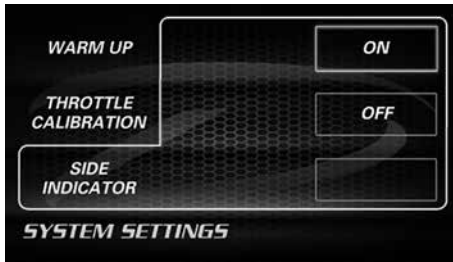

14.4.19. Speed unit

The speed unit can be chosen from km/h and MPH.

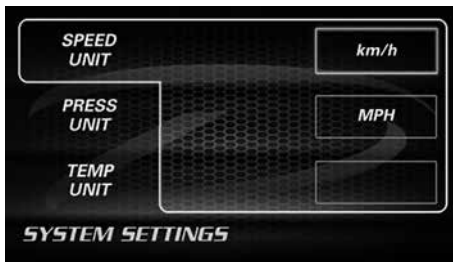

14.4.20. Press unit

The pressure unit can be chosen from kPa and PSI.

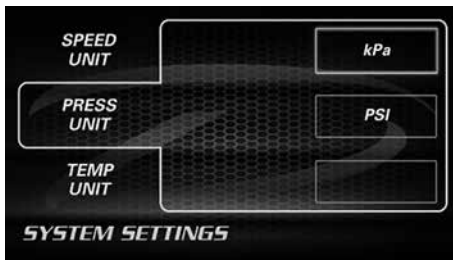

14.4.21. Temp unit

The temperature unit can be chosen from °C and F° .

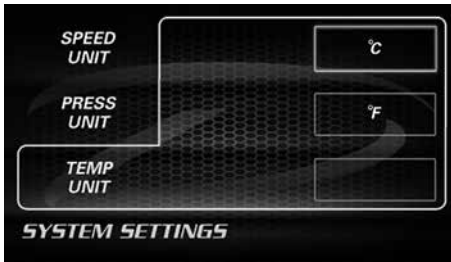

14.4.22. Time difference

Set the time difference to toward the standard time (UTC). Japan standard time is +9:00.

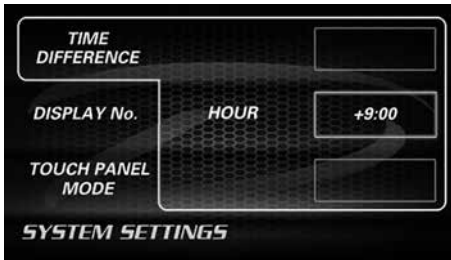

■ Setting range

Item	Value	1 step
TIME DIFFERENCE	-12:00~+12:00	30 minutes

14.4.23. Display No.

Display No. needs to be set when more than one digital display other than DSDF is connected to ADVANCE System. In addition, one of the digital displays needs to be selected as an ACTIVE display in order to activate the dim sensor. The display (illumination) brightness is controlled automatically based on the dim sensor mounted on the ACTIVE display.

To set an ACTIVE display, all the connected digital displays need to have each different display No. from 1 to 7. The numbers does not need to be consecutive.

⇒Refer to the manual for the ADVANCE digital display.

⇒See section "12.3. Multi Information Display (MID)" on page 116.

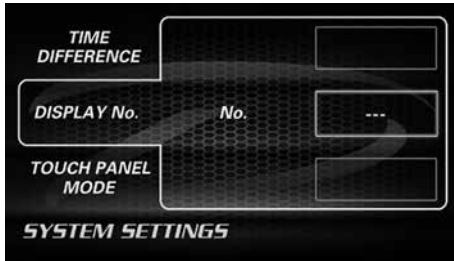

Confirmation

- ❗ Each display needs to have a different display No.
- ⚠ If any display other than DSDF is not connected to the ADVANCE System, this setting is not necessary.

■ Setting range

Item	Value	1 step
Display No.	1 ~ 7	1

14.4.24. Touch panel mode

The sensitivity of the touch panel can be set.

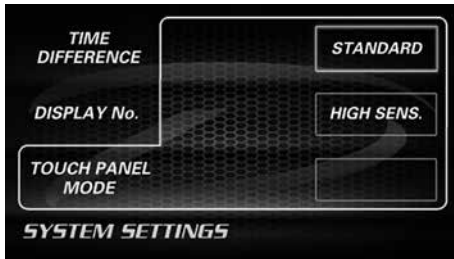

14.4.25. Setting value reset

All the setting values can be reset.

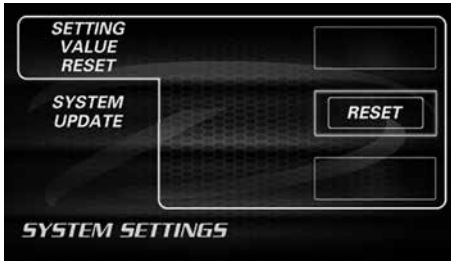

14.4.26. System update

The system can be updated by using a USB flash drive. Update files can be downloaded from the Defi website.

⇒ Updates will be announced on the Defi website.

Save an update file to a USB flash drive and connect it to DSDf. Then choose SYSTEM UPDATE and press **[OK]** button.

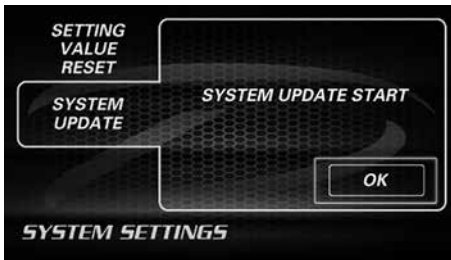

Caution

⊘ Do not turn off the power while updating. Do not pull out the USB flash drive while updating. It may cause product malfunction or update error.

Confirmation

⚠ When an update file is broken or not found in a USB flash drive, DSDf is not updated. Please check the file.

14.5. Trip reset

The trip meter of DSDf can be reset.

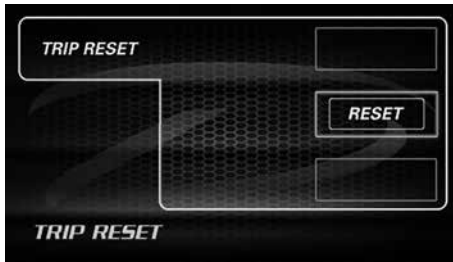

14.6. Display OFF

The LCD panel and indicators can be turned off. To turn on the panel and indicators, touch the panel or press any switch.

15. ADVANCE setup mode

<for customer>

"ADVANCE warning setup" and "ADVANCE System setup" can be set if DSDP is connected to ADVANCE System.

Confirmation

⚠ This section is applicable to DSDP which is connected to ADVANCE System.

⚠ If ADVANCE System has already installed and configured, resetting is not necessary after installing DSDP.

⇒ Refer to the manuals for ADVANCE Control Unit and ADVANCE digital display for details.

15.1. ADVANCE warning setup

Operate with the switch for ADVANCE Control Unit.

Set the slide switch to [SET] and press the [! WARN. SET] button.



Set the slide switch to [REAL] after the setup is done.

15.2. ADVANCE System setup

Operate with the switch for ADVANCE Control Unit.

Set the slide switch to [SET]. Then press and hold the [! WARN. SET] button.





Choose an item listed on the screen by pressing [UP▲ / DOWN▼] button.
Then press [! WARN. SET] button.

Set the slide switch to [REAL] after the setup is done.

■ Setup items listed on DSDF in ADVANCE setup mode

Setup items	Setup options
Unit	km/h kPa °C , MPH PSI °F
Speed pulses	2, 4, 8, 16, FREE
Number of engine cylinders	1, 2, 3, 4, 5, 6, 8
Tachometer response	HIGH, MIDDLE, LOW
Dimmer	AUTO, MANUAL
Special display	※
Warm up	※
Clock	※

Items with ※ are not displayed on DSDF because they concern only ADVANCE System not DSDF.

15.2.1. Speed pulse setting [SPEED PULSES]

Set the number of speed pulse according to your vehicle.

If your vehicle is not 2, 4, 8, or 16 pulse, the pulse free setting. Choose [FREE] and push [REC] button while the vehicle is moving at 60km/h.



- ❗ Ask fellow passengers to operate. Do not operate while at the wheel. Operating while driving could result in an accident.



PULSE FREE

**Speed Pulse
Completed !**

ADVANCE SYSTEM SETUP

15.2.2. Number of cylinders setting [ENGINE CYLINDERS]

Set the number of cylinders of your vehicle.

15.2.3. Tachometer response setting [TACHO RESPONSE]

Tachometer response can be selected from [HIGH], [MIDDLE], and [LOW].

15.2.4. Dimmer setting [DIMMER]

The dimmer setting for ADVANCE System can be selected between [AUTO] and [MANUAL].

※The dimmer setting for DSDF is automatic only.

16. Troubleshooting

<for customer and installation personnel>

Warning

- ❗ If any indications of troubles are found in the product, stop the engine and check the product, wiring, and the vehicle right away. Continued use without checking could result in a serious accident.
- ❗ If any trouble is found while using, setting, and operating, ask the store where this product was installed or purchased to check the trouble. Inspection by a customer could result in accidents or malfunction.

Condition	Possible cause	Corrective action
<ul style="list-style-type: none"> <input type="radio"/> Does not operate. <input type="radio"/> Power is not supplied. 	<ul style="list-style-type: none"> <input type="radio"/> Wiring of the power supply wire is improper. <input type="radio"/> The fuse of the power supply wire is blown out. <input type="radio"/> The locks of the solderless connectors are not locked tightly. 	<ul style="list-style-type: none"> <input type="radio"/> Check the wirings of +B, IGN, GND as per instructions in this manual. <input type="radio"/> Check wiring and replace the fuse. <input type="radio"/> Check the lock of the solderless connectors.
<ul style="list-style-type: none"> <input type="radio"/> Does not carry out the ending mode. 	<ul style="list-style-type: none"> <input type="radio"/> The battery wiring is improper. 	<ul style="list-style-type: none"> <input type="radio"/> Check wiring of +B as per instructions in this manual. <input type="radio"/> Check the solderless connector of battery wiring.
<ul style="list-style-type: none"> <input type="radio"/> The brightness of the illumination doesn't change in tandem with the outside brightness. 	<ul style="list-style-type: none"> <input type="radio"/> The dimmer setting is "FIXED MAX BRIGHTNESS." 	<ul style="list-style-type: none"> <input type="radio"/> Change the dimmer setting.
<ul style="list-style-type: none"> <input type="radio"/> The brightness of the illumination darkens in contradiction to the outside brightness. 	<ul style="list-style-type: none"> <input type="radio"/> DSDF got hot and dimmed automatically by self-protection function. 	<ul style="list-style-type: none"> <input type="radio"/> It's not a malfunction. The brightness will return automatically when DSDF gets cold.
<ul style="list-style-type: none"> <input type="radio"/> The vehicle speed is slightly lower than the value displayed on the original speedometer. 	<ul style="list-style-type: none"> <input type="radio"/> Vehicle speed displayed on the original speedometer is up to 10% higher than the actual vehicle speed. 	<ul style="list-style-type: none"> <input type="radio"/> If the difference is up to 10%, it's not a malfunction.
<ul style="list-style-type: none"> <input type="radio"/> USB error is displayed. 	<ul style="list-style-type: none"> <input type="radio"/> The USB flash drive is not proper. 	<ul style="list-style-type: none"> <input type="radio"/> Check the requirements of a USB flash drive.
<ul style="list-style-type: none"> <input type="radio"/> The touch panel doesn't react. 	<ul style="list-style-type: none"> <input type="radio"/> Centers of each area are not touched. 	<ul style="list-style-type: none"> <input type="radio"/> Touch centers of each area.
<ul style="list-style-type: none"> <input type="radio"/> Nothing is displayed on the screen while the power is on. 	<ul style="list-style-type: none"> <input type="radio"/> The display is turned off in the system setting. 	<ul style="list-style-type: none"> <input type="radio"/> Check the display off setting.

17. Repair parts

<for customer and installation personnel>

Parts number	Parts name
PDF15901G	Switch unit for DSDF
PDF15902H	GNSS antenna
PDF15903G	Installation parts for DSDF
PDF07702H	Power supply wire
PDF07703G	Installation parts for ADVANCE Control Unit
PDF14503H	OBDII wire
PDF14502H	Adapter wire for OBDII wire
PDF07706G	Switch unit for ADVANCE Control Unit
PDF07710H	ADVANCE meter wire (2m, 6 3/5ft)
PDF06503S	Turbo sensor for 200kPa and under
PDF00703S	Pressure sensor (1/8PT)
PDF00903S	Temperature sensor (1/8PT)
PDF08608G	Rubber hose, three way joint
PDF06505H	Turbo sensor wire
PDF08105H	Oil pressure sensor wire
PDF05602H	Oil temperature sensor wire
PDF05603H	Water temperature sensor wire
PDF09705H	Speed and tachometer signal wire for ADVANCE System
PDF05005G	Fuse for Power supply wire (4A) 2pcs

18. Optional parts

<for customer and installation personnel>

Parts number	Parts name
PDF14604S	Turbo sensor for 300kPa/45PSI
PDF07806SS	ADVANCE Sensor set for 200kPa and under
PDF08106SS	Oil pressure sensor set (1/8PT)
PDF08205SS	Fuel pressure sensor set (1/8PT)
PDF08305SS	Oil temperature sensor set (1/8PT)
PDF08405SS	Water temperature sensor set (1/8PT)
PDF08505SS	Exhaust temperature sensor set (1/8PT)

Parts number	Parts name
PDF07707H	ADVANCE meter wire (25cm, 10in)
PDF07708H	ADVANCE meter wire (50cm, 1 3/5ft)
PDF07709H	ADVANCE meter wire (1m, 3 1/3ft)
PDF06002H	Turbo sensor extension wire (1m, 3 1/3ft)
PDF00707H	Pressure sensor extension wire (2m, 6 3/5ft)
PDF00906H	Temperature sensor extension wire (2m, 6 3/5ft)
PDF01107H	Exhaust temperature sensor extension wire (2m, 6 3/5ft)

Confirmation

❗ For more information, contact our official distributor or visit our website.

19. Warranty/maintenance/servicing

<for customer and installation personnel>

■Warranty card • Terms and conditions

This product is delivered with this operation manual and a warranty card. Please read terms and conditions in this manual thoroughly and keep the warranty card in a safe place. Failure to show this warranty will void the warranty.

■Warranty period

Limited one year warranty. The warranty period starts at the date of retail purchase by the original end-user purchase. Please confirm the warranty card is provided with the information of retail store where purchased. Please refer to Limited Warranty for details.

Caution

 Except in the case of defects, we shall not be liable for any trouble including violation, accident or improper wiring resulting from using this product.

 The warranty does not cover any unauthorized repair performed or caused to be performed by the end user. Such action can destroy or damage this product.

■Inspection

Please ask the shop you purchased the product for inspection if any defect in product is suspected. We don't accept the order of fixing because Defi products require installation and wiring to the vehicle.

In case you cannot go to the shop you purchased because of move-out or closure of shop, please ask the nearest Defi Distributor listed in the Defi website.

Confirmation

 For a repair/inspection service, take the warranty card and customer contact information with you.

Please conduct periodic inspections by Defi through a shop which sells Defi products or Defi's official distributor every five years. Inspection is available at an additional cost. In the case you purchase used products or used



vehicles with products of Defi, please have an inspection by Defi as well before using them.

■ Label

The label stuck on the product is for tracing purposes. Do not peel it off.

■ Discarding the products

Please dispose products in accordance with disposal laws, state laws and local government. A recycle label on the package indicates that the package is recyclable.

<Customer contact information>

Please provide the following information to a store representative when you ask for an inspection.

1. Your contact information		
address, zip code :		
name :		
phone number :		
email address :		
2. Name and address of the store where purchased and installed.		
3. Information about your vehicle		
manufacture and car model :		
model year :		
vehicle type :		
engine type :		
engine displacement :		
transmission (MT/AT) :		
speed limit canceller	with	without
genuine tachometer	with	without
engine swap	with	without
changing ignition device	with	without
changing ECU	with	without
the way to install the sensor :		
other specification :		
4. Your Defi products (including the products that do not need inspection this time)		
5. Describe your experience (when? do what? what product? what happened? then what?)		



■ Terms and Conditions

LIMITED PRODUCT WARRANTY AND LIMITED PRODUCT LIABILITY

A. Limited Warranty

- a. Our sole obligation to you after the sale of a product is to replace, without charge, the product or any component thereof discovered to be defective within a period of one (1) year from the purchasing date (the "Warranty Period"). You accept sole responsibility for the proper assembly operation and regular maintenance of the product. This limited warranty is void if any product is damaged by accident, misuse, improper installation, or abuse, including tampering or damage in transit. Further, this limited warranty is void if you sell or otherwise transfer a product to a third party, regardless of whether the transfer takes place within the Warranty Period.
- b. Our liability to you resulting from the sale of any product, including liability for any latent defects found within the Warranty Period, shall not exceed the total purchase price paid for the product by you.
- c. YOU UNDERSTAND AND AGREE THAT WE MAKE NO REPRESENTATIONS OR WARRANTIES OF ANY KIND, EXPRESS OR IMPLIED AS TO ANY MATTER WHATSOEVER, INCLUDING THE CONDITION OF THE PRODUCT OR ANY COMPONENT PARTS THEREOF, ITS MERCHANTABILITY OR ITS FITNESS FOR ANY PARTICULAR PURPOSE AND YOU ACCEPT IT, "AS IS," "WHERE IS."
- d. You also understand that we are not granting any express warranties, other than those stated herein. These include only those warranties enumerated in paragraph A. a. There are no other express warranties granted anywhere in these terms and conditions of sale, and you understand and agree to this fact as part of the bargained for exchange of this sale. Nowhere else, except as stated in this paragraph, in this contract is there intended, by either party, for there to be any express warranties granted to you.
- e. EXCEPT AS OTHERWISE PROVIDED HEREIN, WE SHALL NOT BE LIABLE FOR DAMAGES, INCLUDING SPECIAL, INCIDENTAL OR CONSEQUENTIAL DAMAGES WHETHER IN CONTRACT OR IN TORT ARISING OUT OF OR IN CONNECTION WITH THE PERFORMANCE OF ANY PRODUCT OR ANY COMPONENT PART THEREOF OR ITS USE BY YOU, AND WE SHALL NOT BE LIABLE FOR ANY SPECIAL, INCIDENTAL OR CONSEQUENTIAL DAMAGES ARISING OUT OF OR IN CONNECTION WITH YOUR USE OF THE PRODUCT.
- f. The warranty on this product is void if the product is modified, changed, adjusted or damaged. This product is to be used only in the ways for which it is designed and marketed for, any deviations from the intended

- uses will void the warranty and will excuse any possible liability of ours.
- g. You accept sole responsibility for the proper assembly, operation and regular maintenance of the product. This limited warranty is void if the product is damaged, changed, altered, or modified by accident, misuse, improper installation, or abuse, including tampering or damage in transit or while in use. YOU HAVE MADE AN INDEPENDENT INVESTIGATION OF THE PURCHASED COMPONENTS AND HAVE RELIED SOLELY ON YOUR OWN INVESTIGATION, BARGAINING AND JUDGMENT IN REFERENCE THERETO. YOU ACKNOWLEDGE THAT YOU ARE NOT RELYING ON OUR SKILL OR JUDGMENT TO SELECT OR FURNISH GOODS SUITABLE FOR ANY PARTICULAR PURPOSE IN PURCHASING OUR PRODUCTS, YOU HAVE NOT RELIED OR ACTED UPON ANY REPRESENTATIONS OR WARRANTIES ON OUR PART NOT SPECIFICALLY SET FORTH HEREIN.
- h. This limited warranty gives you specific legal rights. You may also have other rights which vary from state to state. Some states do not enforce contractual limitations on how long an implied warranty lasts, when an action may be brought, or the exclusion or limitation of incidental or consequential damages, so the above limitations or exclusions may not apply to you.

B. Modification Strictly Prohibited

You understand and agree that any modification whatsoever, of the product, is strictly prohibited. You also agree not to modify the product in any manner regardless of whether such modification is material or immaterial. You also acknowledge that any modification of the product will void your limited warranty and bar you from any recovery or any remedy in a court of law or equity. Modification is strictly forbidden unless expressly authorized by our prior written approval. You agree not to make any modifications to the product and agree not to use any parts, components, or accessories in connection with the installation and use of the product that are not authorized and approved by us.

C. Indemnity and Release

- a. You understand and agree that many factors beyond our control affect the operational safety of the product, including but not limited to the installation of the product according to the instructions provided with the product.
- b. You also understand and agree that the installation of the product may involve the use of tools, equipment and construction methods which may present safety hazards which are beyond our control. You also understand and agree that the use of some of our products may create hazards and



lower your ability to control your vehicle.

- c. You agree, as part of the bargained for exchange, to protect, indemnify, save harmless and release us, our authorized agents, employees, officers, directors and shareholders from and against all liabilities, obligations, claims, damages, penalties, causes of action, costs and expenses, imposed upon or incurred by or asserted against us or any assignees of ours, by you or any third party by reason of the occurrence or existence (or alleged occurrence or existence) of any use, installation, assembly, possession or operation of the product, any loss, damage or destruction of the product as of and after delivery (a "casualty occurrence"), and any other act or event relating to or caused by the product, including but not limited to, consequential or of the terms and conditions hereof, or any and all liability for property loss or damage, or any and all damage resulting from death or personal injuries, including loss of services which any person may sustain on account of, arising out of, or in connection with any use, maintenance, possession or operation of the product. In the event that any action, suit or proceeding is brought against us or any of our authorized agents, employees, officers, directors or shareholders by reason of any such occurrence, you will, upon our request and at your expense, resist and defend such action, suit or proceeding or cause the same to be resisted and defended by counsel designated and approved by us.

20. 型紙 (取り付け業者様へ)

20. Paper template

<for installation personnel>

20.1. DSDF 本体

Defi Web サイトに PDF データを用意していますのでご利用ください。
△メーターパネルは 2mm 以上の厚さが必要です。

20.1. DSDF Main unit

The PDF data can be downloaded from the Defi website.
△The thickness of a mounting panel needs to be more than 2mm.

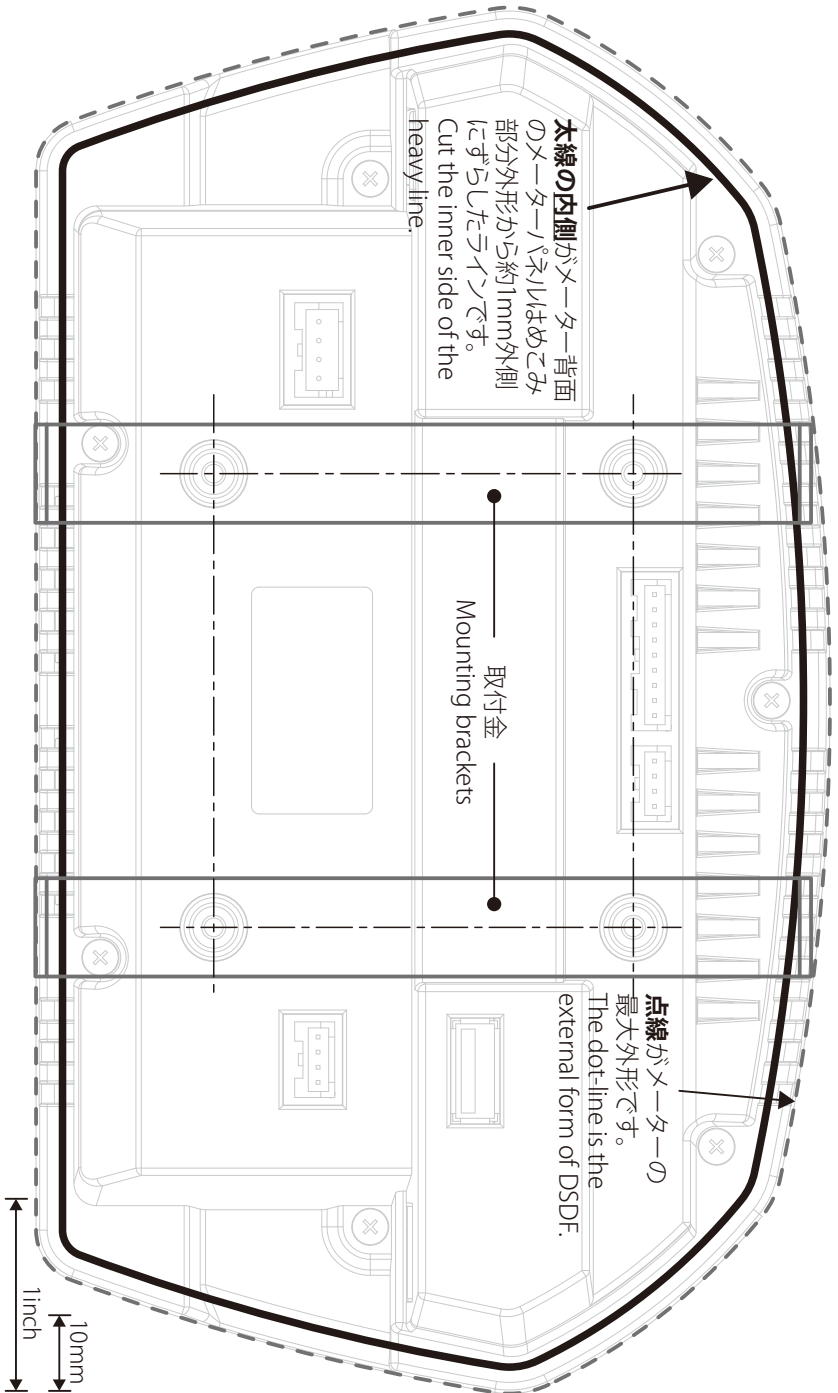

20.2. DSDF 用スイッチ

Defi Web サイトに PDF データを用意していますのでご利用ください。

20.2. Switch unit for DSDF

The PDF data can be downloaded from the Defi website.

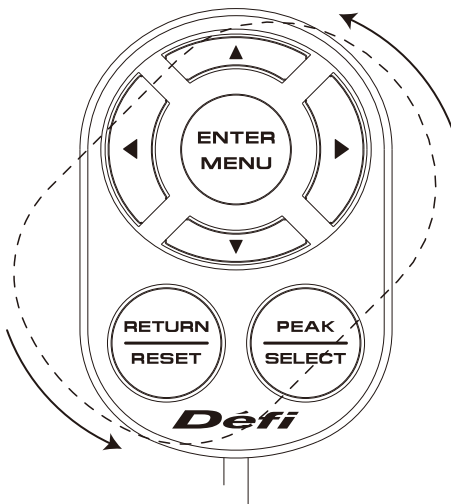
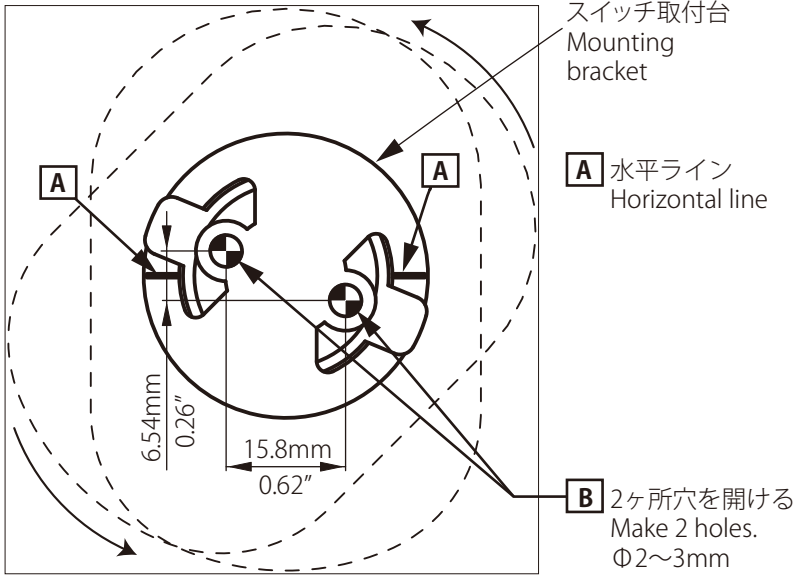



デフィースポーツディスプレイエフ取扱説明書

- 発行 第2版 2018年12月
- 製造元 日本精機株式会社
- 連絡先 日本精機株式会社 Defi お客様相談室
- 【住所】 〒940-8580 新潟県長岡市東蔵王2丁目2-34 日本精機株式会社 Defi
- 【電話番号】 (03)5814-0081 (Japanese only)
- 【受付時間】 10:00 ~ 12:00, 13:00 ~ 17:00(土・日曜、祝日、当社休日を除く平日)
- 【Web サイト】 <https://www.nippon-seiki.co.jp/defi/>

Defi Sports Display F Operation Manual

- Issue Second edition: December, 2018
- Manufacturer Nippon Seiki Co., Ltd.
- Contact Information Defi, Nippon Seiki Co., Ltd.
- 【Address】 2-34 Higashi-Zaoh 2-chome, Nagaoka-shi, Niigata 940-8580 JAPAN
- 【URL】 <https://www.defi-shop.com/>

特許出願中
PATENT PENDING