



*CD-7/CD-7L  
COLOR DASH DISPLAY  
CAN LOGGER SYSTEM*



*30-5500*

*30-5501*

*30-5502*

*30-5503*

AEM Performance Electronics  
2205 126th Street Unit A, Hawthorne, CA 90250  
Phone: (310) 484-2322 Fax: (310) 484-0152  
<http://www.aemelectronics.com>  
Instruction Part Number: 10-5500  
Document Build 11/17/2016

## **Part I - Quick Start Guide**

The manual contains two parts. Part I is a quick start guide that includes basic information to get you up and running quickly.

## Introducing AEM DashDesign

The AEM Color Dash Display and CAN Logger includes the AEM CD-7 / CD-7L color display and AEM DashDesign editing software. Screen pages are designed graphically. The screen layout displayed in AEM DashDesign is identical to the layout displayed on the AEM CD-7 / CD-7L.

In addition to the graphical display editor, AEM DashDesign also provides a comprehensive setup editor to program the input, output and mathematical functionality of the AEM CD-7 / CD-7L.

Once created, setups are uploaded to the AEM CD-7 / CD-7L via a USB link.

## Kit Contents

### 30-5500 Contents:

- 1 x CD-7
- 4 x AV mount hardware
- 1 x Harness
- 1 x USB communication cable
- 1 x User manual

### 30-5501 Contents:

- 1 x CD-7L
- 4 x AV mount hardware
- 1 x Harness
- 1 x USB communication cable
- 1 x USB bulkhead extension cable
- 1 x User manual



**30-5502 Contents:**

1 x CD-7  
 4 x AV mount hardware  
 1 x Harness  
 1 x USB Communications cable  
 1 x Vehicle Dynamics Module  
 1 x GPS antenna  
 1 x Velcro  
 1 x User manual

**30-5503 Contents:**

1 x CD-7L  
 4 x AV mount hardware  
 1 x Harness  
 1 x USB Communications cable  
 1 x USB Bulkhead extension cable  
 1 x Vehicle Dynamics Module  
 1 x GPS antenna  
 1 x Velcro  
 1 x User manual



## CD-7 Features

- Full color CAN display and logger (CD-7L only)
- Completely user definable CAN receive
- Dual CAN bus
- Full graphics display with up to 6 different pages
- Unit ships with 6 display pages for the AEMNet data stream as the default setup
- Completely user definable graphical layouts
- Stand-alone PC program to create and customize layouts
- Water resistant enclosure with rear facing DTM 12 pin connector
- 7" (diag) 800x400 super bright color display
- Night mode input
- 7 shift lights and 2 alarm LEDs
- 200mb onboard logging memory (CD-7L only)
- Up to 100hz sample rate (CD-7L only)
- Log data downloaded and viewed with AEMdata via USB port with sealed bulkhead extension cable (CD-7L only)
- Beacon input

# CD-7 Mechanical and Mounting

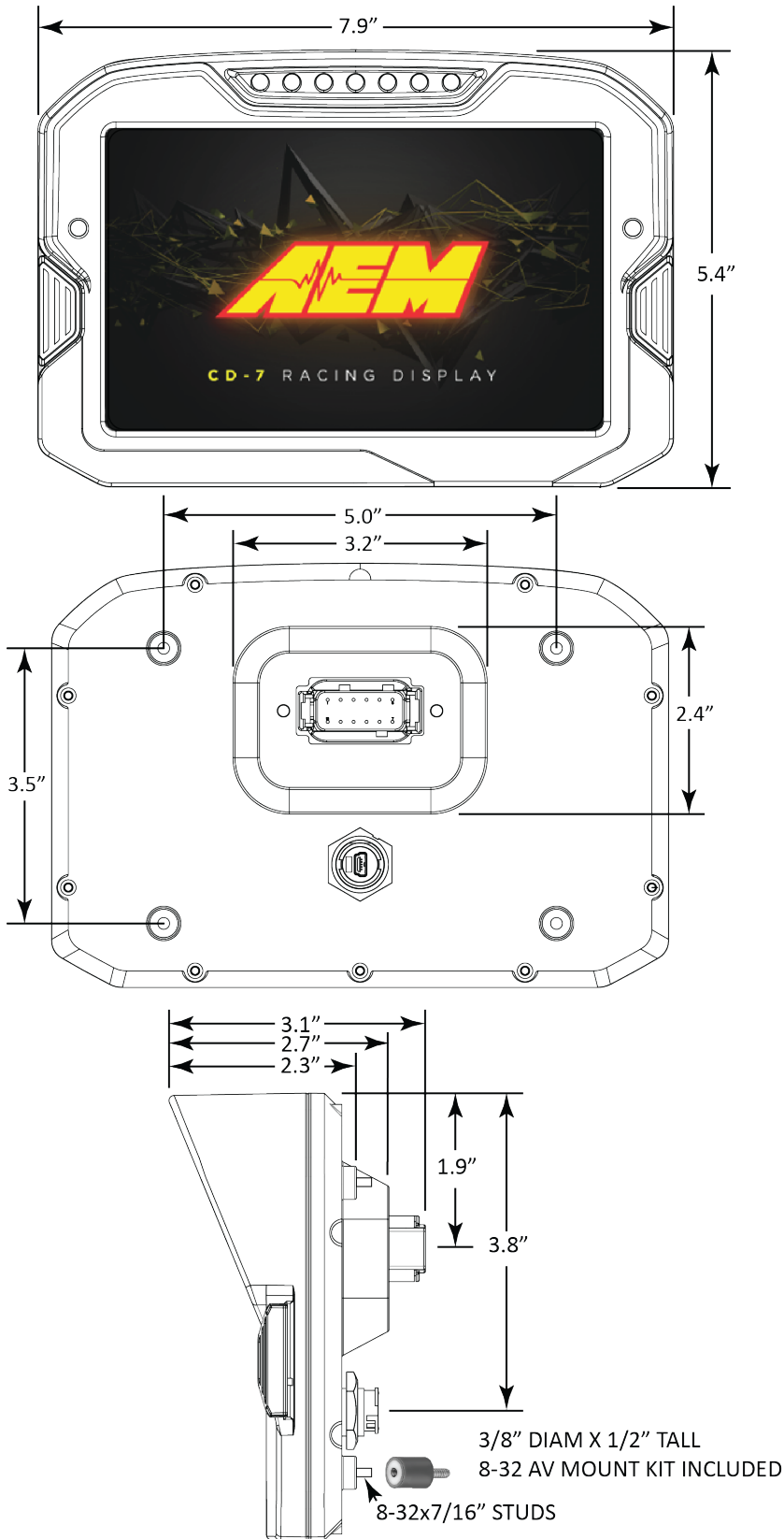

# CD-7 Harness and Wiring

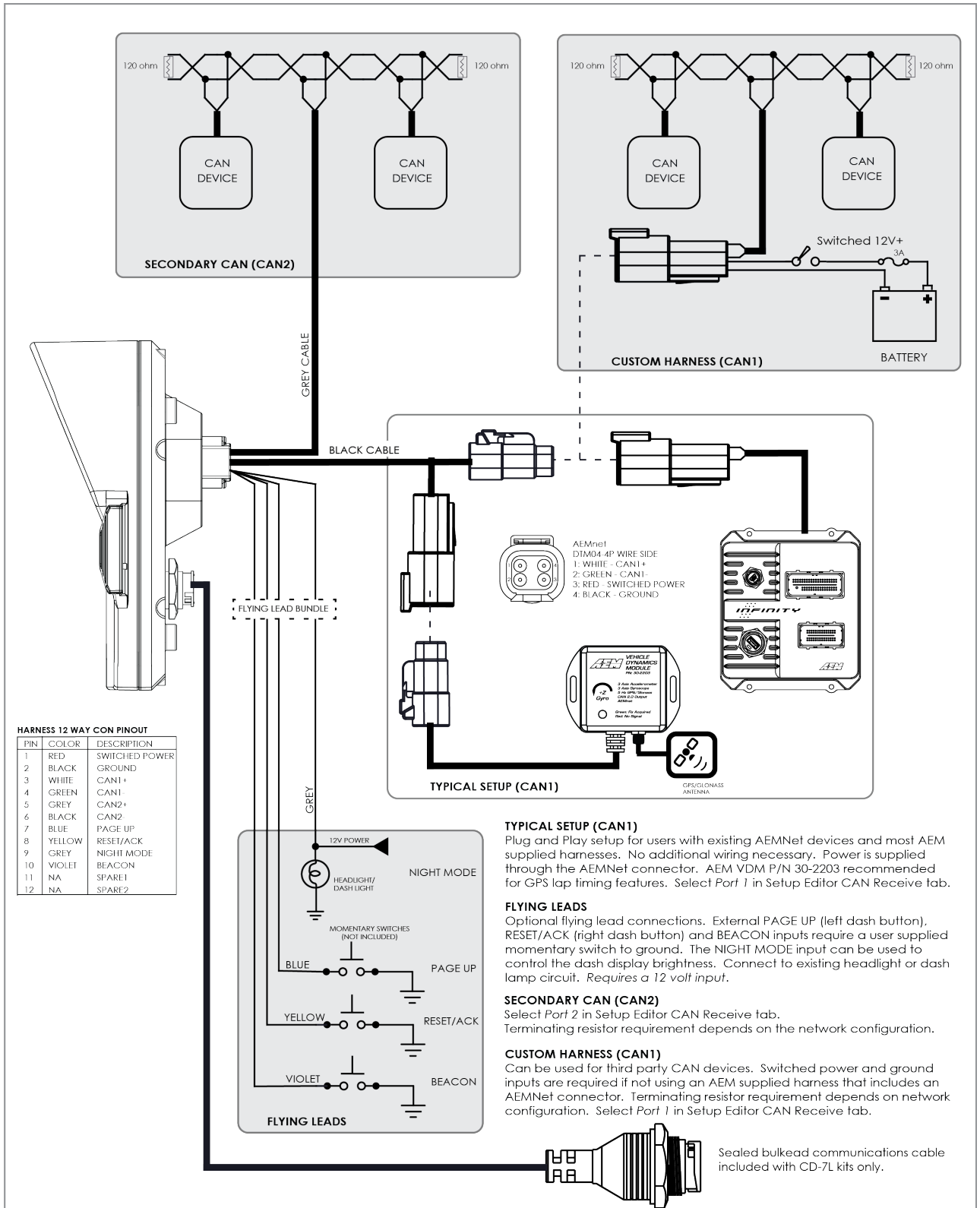

Drawing: BASIC HARNESS WIRING

PRODUCT: AEM CD-7/CD-7L

Date: 10/19/16

Rev: A

Engineer: Armish

## Installing AEM DashDesign

AEM DashDesign is distributed as a single install executable. To install, run AEM DashDesign Setup.exe and follow the on-screen instructions.

### Installing USB Drivers

The installation program will automatically install the USB drivers required by AEM CD-7 / CD-7L. However, on rare occasions, it may be necessary to install the USB drivers manually. To do this:

- Connect the AEM CD-7 / CD-7L to the PC.
- When the add new hardware wizard appears, select "Install from a list or specific location" and click Next.
- Choose "Search for the best driver in these locations" and check "Include this location in the search"
- Click the Browse button and navigate to the Drivers folder sub folder in the AEM DashDesign installation directory.
- Click the Next button and the driver installation will proceed automatically.

## VDM for GPS speed and lap timing

The AEM Vehicle Dynamics Module, PN 30-2203 can be used in conjunction with the AEM CD-7L dash for lap timing and track mapping features.



### VDM Features:

- GPS latitude & longitude delivers AEMdata track map functionality via AEMnet CANbus
- Easily Add GPS, lateral G, altitude, pitch and roll data to engine data logs!
- Simply install it in the correct position, connect to AEMnet and the data streams through AEMnet CANbus!

- Continuous time data can be used for Infinity USB log file naming
- Accelerometers supply all 3-axis acceleration data for chassis tuning
- Ideal for road racers who want to use the gyrometer data for suspension adjustments
- Perfect for drag racers who want G-loads and wheel stand data
- GPS vehicle speed, heading and altitude logged for data analysis, lap comparisons
- Status LED indicates power & GPS signal
- Weather resistant enclosure with IP67 rated GPS/GLONASS antenna

The screenshot shows a software dialog box titled "Lap Timing Setup". It is divided into several sections. The first section, "Lap Timing Mode", has two radio buttons: "Beacon" (which is selected) and "GPS". The second section, "Beacon Type", also has two radio buttons: "Standard" (selected) and "AIM". The third section, "Average Speed Setup", includes a text box containing "GPS\_Speed" and a "Clear" button. The fourth section, "GPS Mode Setup", contains three dropdown menus labeled "GPS Lon.", "GPS Lat.", and "GPS Course", and a text input field for "Track Width/m" with the value "50". At the bottom of the dialog are "Cancel" and "OK" buttons.

Go to **Setup | Lap Timing...** Select the GPS button to configure for GPS lap timing. A virtual start/finish line creation feature allows you to use the beacon input (violet wire in flying lead harness) to set a virtual start/finish line. While driving the course, press the momentary beacon switch when you cross the start/finish line. Hold for a few seconds until the left and right LEDs flash. The system captures the location information when you first press the button. Holding for a few seconds eliminates the likelihood of false triggering the input. You can define your virtual track width in the dialog window. Set to the approximate width of the track surface plus some extra. The dash creates a start finish line the width of the Track Width/m setting perpendicular to the heading when the start finish is set. It then checks whether the previous two points cross this line; the only caveat being that the heading is +/- 90 degrees of the original heading.



## Installation

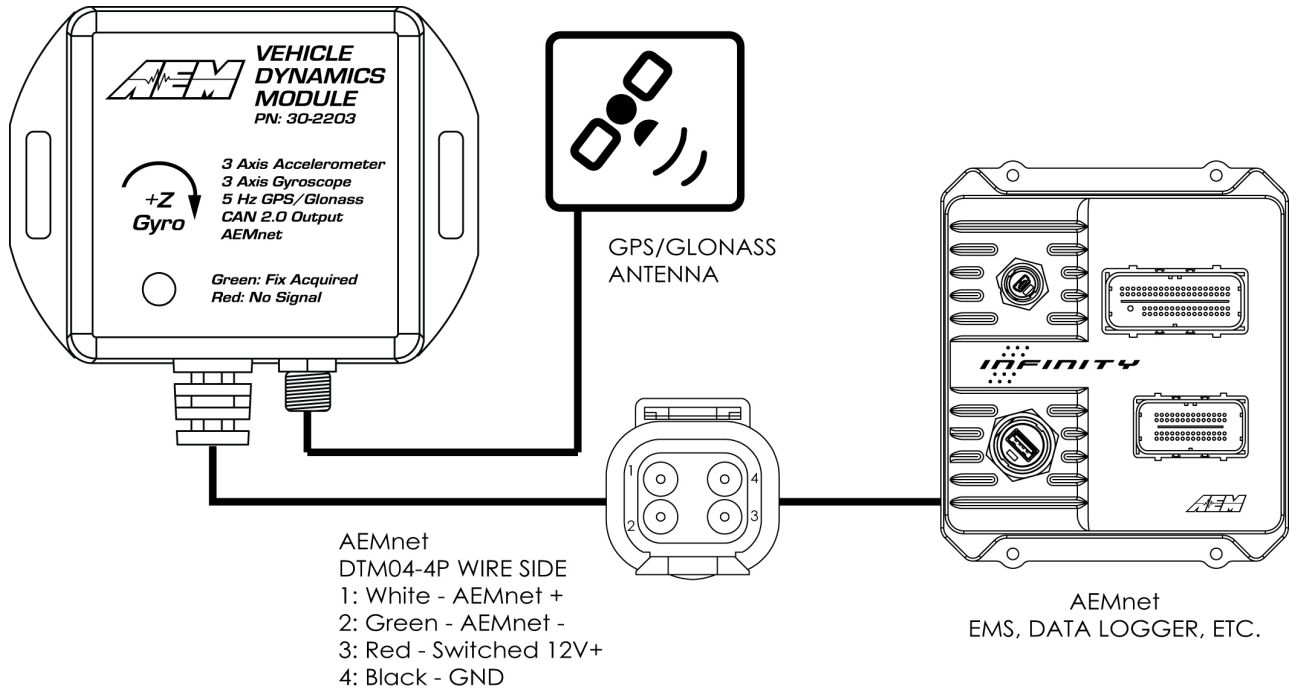

The VDM is equipped with an AEMnet connector (power, ground, and CAN) so that it is a true plug and play experience when used with other AEMnet products such as the Infinity ECU.

Ideally, the VDM module should be installed near the center (both fore/aft and side-to-side) of the vehicle and as low as possible. For example, the module may be mounted to the floor of the vehicle between the two front seats. The module should be mounted using the provided "hook-and-loop" material or may be more rigidly mounted using fasteners through the module's mounting ears. Take care to avoid over-torquing mounting fasteners, if used.

The external markings on the module indicate the orientation of the accelerometer and gyro axes. Typically, the module is mounted so that "+x Accel" is pointed towards the front of the vehicle in the direction of travel. Please make note of this orientation for use when analyzing the data later on.

The antenna should be mounted in a location where the top is pointed towards, and has a clear view of, the sky. The bottom of the antenna is magnetic or additional hook-and-loop material is provided for mounting; the dashboard or rear package shelf are **not** acceptable locations. The antenna should be mounted as high as possible in the center of a metal roof away from other antennas or structures. If the roof of the vehicle is non-metallic then a flat piece of metal at least five inches in diameter, to function as a ground plane, should be fabricated upon which the antenna should be placed.

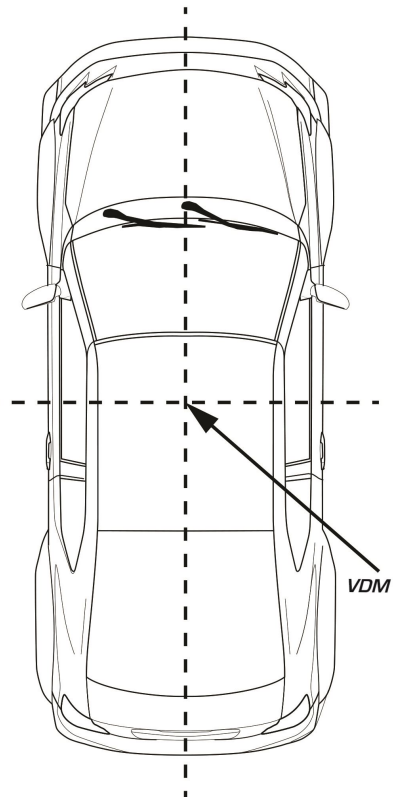

## Status LED

There is a status LED located on the top of the VDM module that gives an indication of its operating status, specifically the quality of the current GPS signal:

LED	Description
OFF	The device is not powered
FLASHING RED	No valid GPS fix
RED	Valid fix, zero satellites in view
FLASHING GREEN	Less than 4 satellites in view
GREEN	4 or greater satellites in view
OTHER	Please contact AEM Support

## Channels / Data

### GPS

The VDM utilizes an internal 5Hz GPS/GLONASS receiver with a matching external active antenna. Faster time to fix, and better global coverage is afforded by the support of both the GPS and GLONASS constellations. The module is designed with an internal super capacitor that will retain the last known satellite position (ephemeris) while power is disconnected from the VDM for up to 2.5 hours. This will allow for a very fast time to fix (<1 sec typ) once the device is turned on again; if power is removed for greater than the 2.5 hours then the time to fix will increase. The capacitor is automatically recharged and never needs to be replaced such as is the case with a more traditional battery.

The following GPS channels are output on AEMnet for logging on your Infinity ECU or other device:

Channel Name	Notes
GPS Latitude [deg]	+ = North, - = South
GPS Longitude [deg]	+ = East, - = West
GPS Speed [mph]	Speed
GPS Altitude [ft]	Above Mean Sea Level (MSL)
GPS Course [deg]	Course over ground, NOT heading
GPS Satellite Count	"Visible" number of satellites
GPS Valid	1 = Valid Fix, 0 = No Fix
GPS Year	UTC Time
GPS Month	UTC Time
GPS Day	UTC Time
GPS Hours	UTC Time
GPS Minutes	UTC Time
GPS Seconds	UTC Time

### Accelerometer / Gyroscope

The following accelerations and yaw rate channels are output on AEMnet for logging on your Infinity ECU or other device:

Channel Name	Notes
Acceleration X [g]	*Longitudinal
Acceleration Y [g]	*Lateral
Acceleration Z [g]	*Vertical
YawRate X [deg/s]	*Roll
YawRate Y [deg/s]	*Pitch
YawRate Z [deg/s]	*Yaw

\*If +x is mounted in the direction of travel

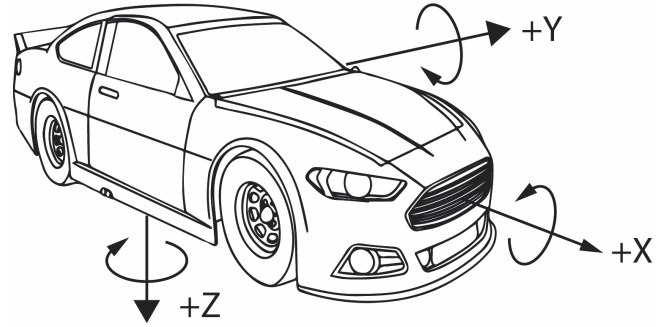

## Display Setups

The display setup file has the extension .aemcd7 and contains all the information needed to configure a color display including connection definition, sensor calibration and screen layout.

### Default Display Setups

AEM supplied setup files will be located in the \Documents\AEM\DashDesign\Setups folder.

You can copy entire pages from another file. First, make sure the target page is open and selected and that the layout is unlocked.

Select: **Edit | Paste Screen From Setup File**

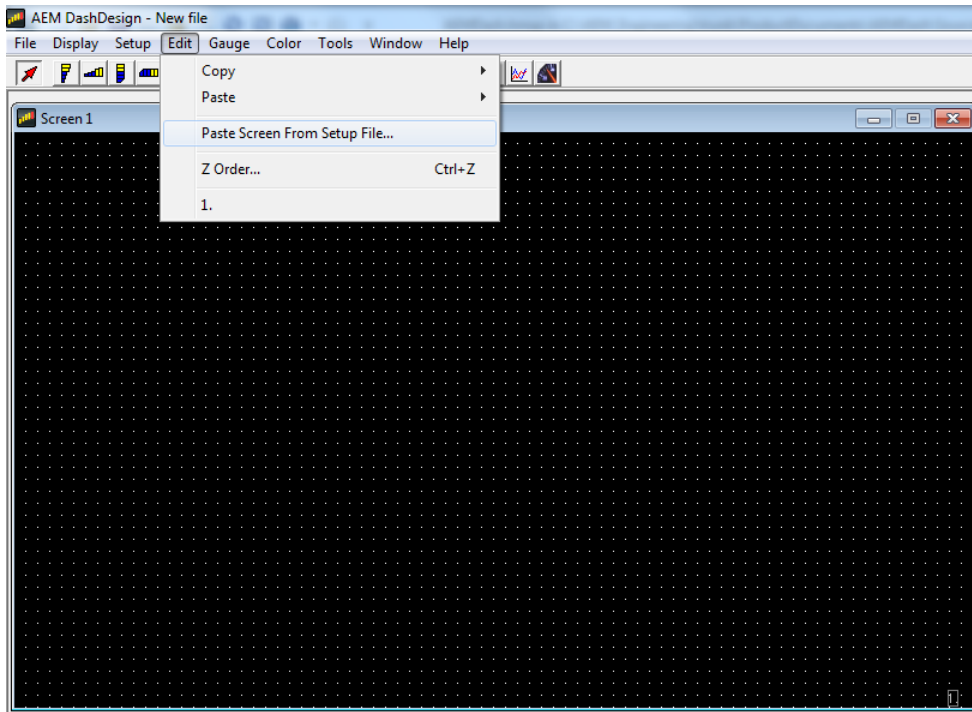

Select the file that contains the screen you want to copy. A window will open showing the six screens in the target file.



Select the screen you want to import by clicking on the screen name and Clicking OK.

**NOTE:** Any missing bitmaps and bitmap selectors will be imported with the page. Bitmaps of the same name are not replaced which potentially could cause unexpected results if bitmaps had been changed between setups. Channel names carry over so even if you import a .dbc file after copying the screens, the names will be tallied up (if they are the same). Any variable string gauges will show "No Input" if the output name is not present. Editing any gauge where the output name is not present will show a blank in the output name - the name is still there and will be used if the output is created at a later date though if you change the combo, it will change the output as expected.

## Opening and Saving Setups

To Open an existing color display setup:

- Select **File | Open....** The file open dialog is shown.
- Select the required display setup file and click **Open**.

The last five files opened can be accessed by selecting **File | Reopen** followed by the appropriate file from the sub menu.

To save a setup under a new filename, select **File | Save As....**, enter a file name in the file save dialog and click the **Save** button. To save a setup with the current name, select **File | Save**.

If a setup or AEM DashDesign is closed and the setup has changed since the last save, a prompt will appear asking if the changes to the setup are to be saved. Select **Yes** to save the changes, **No** to abandon the changes or **Cancel** to return to editing the current setup.

## Basic Editing of Default Setups

To view screens for editing go to **Display | Screen X**

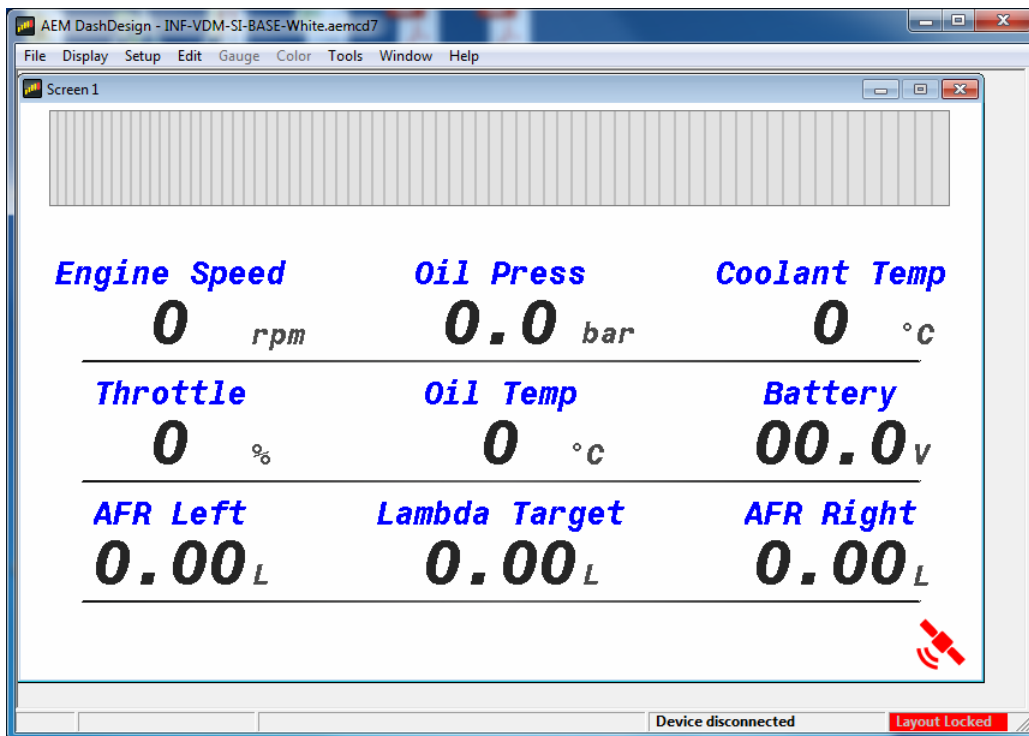
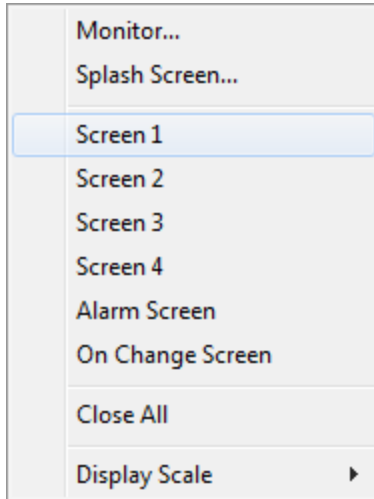

Layout Locked

The Layout Locked feature displayed at the bottom right of the screen prevents unwanted moving of screen items.

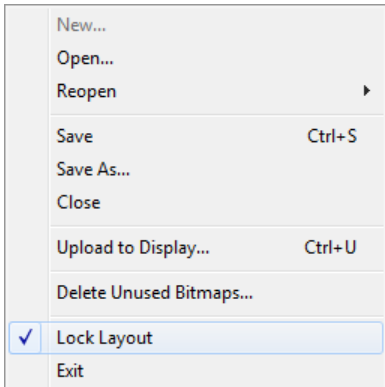

The Layout Locked feature can be disabled by going to **File | Lock Layout** or by clicking the red Layout Locked area of the screen. Caution as inadvertent clicks and drags can move items unintentionally. Some basic editing of the default screens is possible even with the Layout Locked feature turned on. It is a good idea to leave the Layout Locked activated until you specifically need to move or delete a gauge. Having it on prevents you from accidentally moving a gauge or deleting one inadvertently.

## Engine Speed

**0** rpm

Double clicking on the Engine Speed text label in the example above will display the available editing menu.

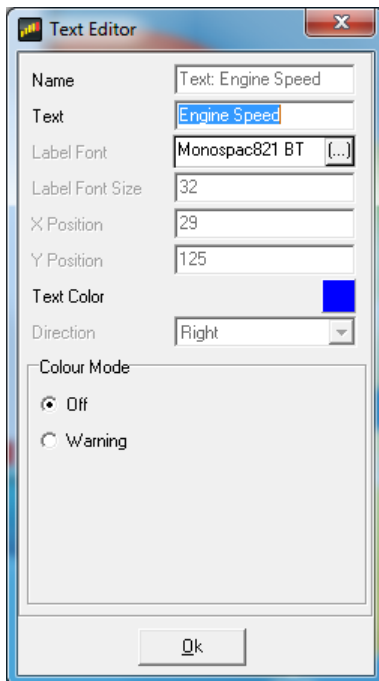

The dialog allows editing of all unlocked characteristics if Layout Locked is turned on. Locked characteristics are typically related to size and position. To change the text displayed in the text label example above, simply

highlight the text and edit. Double clicking on the "0" in the example above opens the value label editor. This is live data displayed on the screen.

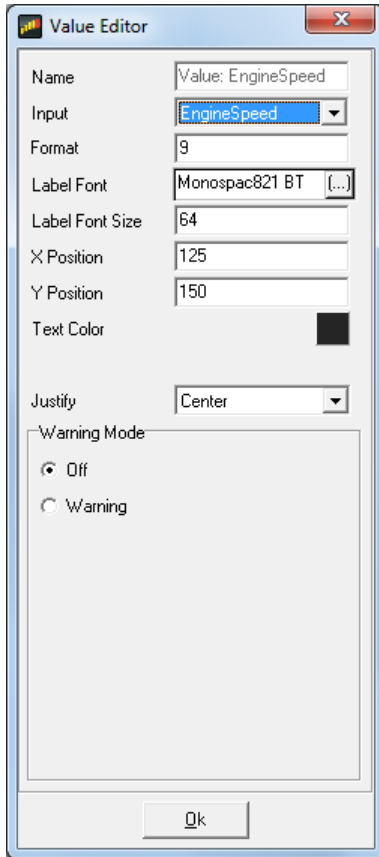

Here you can change the input displayed at this location. Click on the drop down to view a list of available channels.

## The Display Editor

The display editor is the core tool for editing a setup. To open the tool, go to **Setup | Display...**

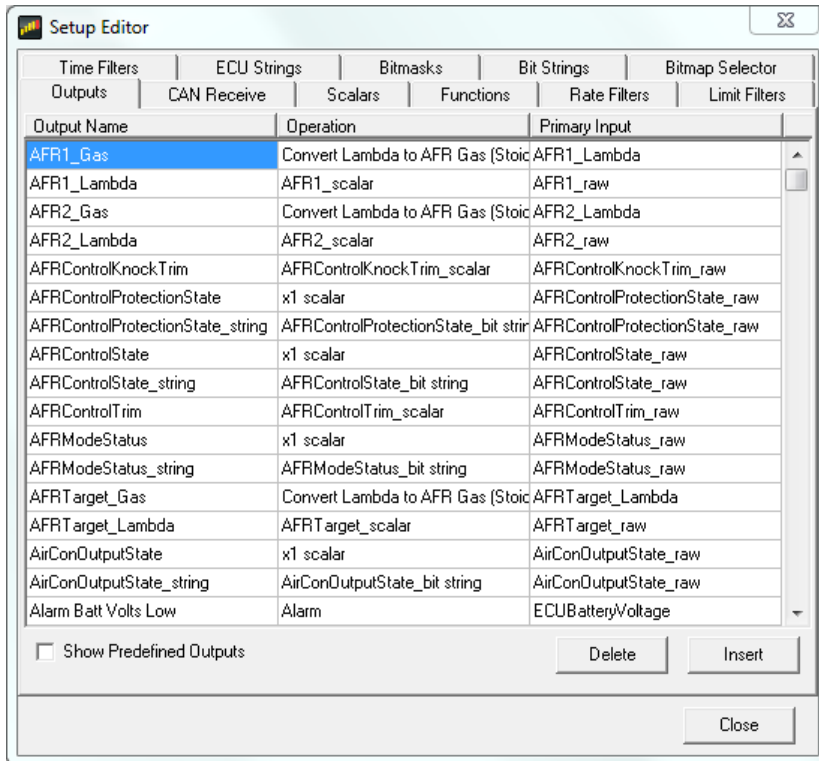

You can think of the display editor as a collection of tools for creating items on your screens. A AEM DashDesign setup consists of four logical components: Sources, outputs, sensors and gauges. These are defined as follows:

- **Sources** or primary inputs are raw data manipulated by an operation.
- **Outputs** are objects that obtain information from one or more sources or other outputs. An output manipulates the obtained data according to the operation associated with the output. The result can then be used in a gauge or another output.
- **Operations** are objects that define how the data is manipulated by an output. Examples of operations are scalars, functions and alarms.
- **Gauges** are objects that are placed on a screen page. There are two types of gauge; static and variable.
  - **Static** gauges do not change their appearance on the screen and include gauges such as text labels or bitmaps.
  - **Variable** gauges change their appearance to reflect data obtained from an output. Examples of variable gauges are bar graphs, tachos and numerical text gauges.
- **Predefined Outputs** are pre-configured within the system and can be used in many ways. Some examples include: Log Mem Free (kb) which displays the amount of free logging memory (CD-7L only) and Night Mode Input Status. This output displays the state of the Night Mode 12v input (Grey wire in flying

lead bundle).  Show Predefined Outputs

Click the Show Predefined Outputs box in the Display Editor to add all Predefined Outputs to the list.



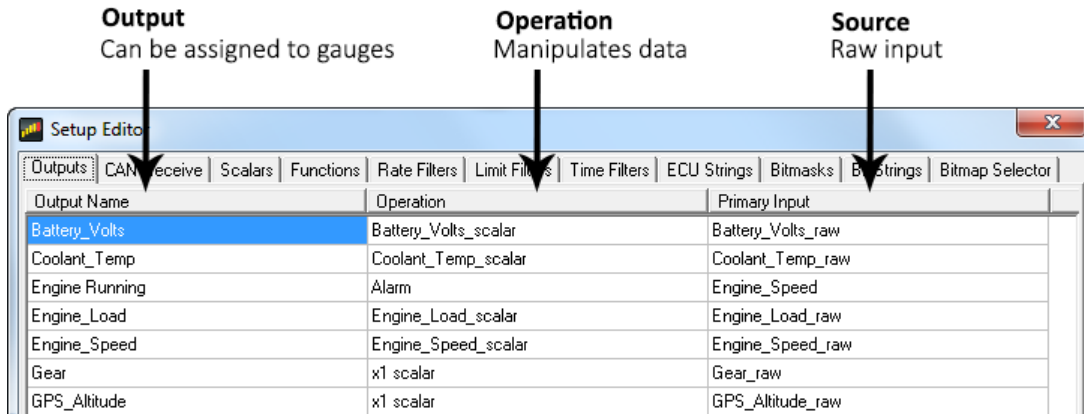

## Default CAN .dbc Support

The AEM DashDesign includes a CAN .dbc import feature. A .dbc file is a standardized format for defining a set of CAN messages. Click on the CAN Receive tab in the Setup Editor.

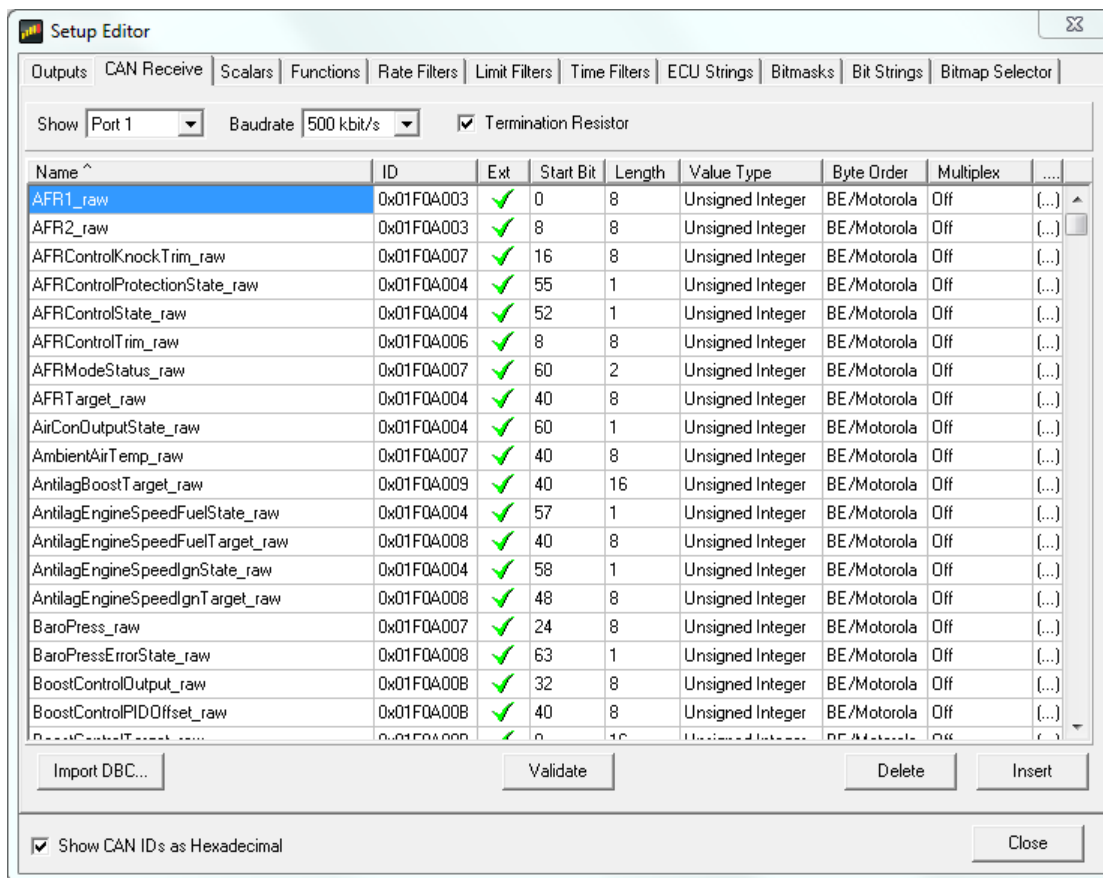

Click on the Import DBC... button to load or append a new .dbc file.

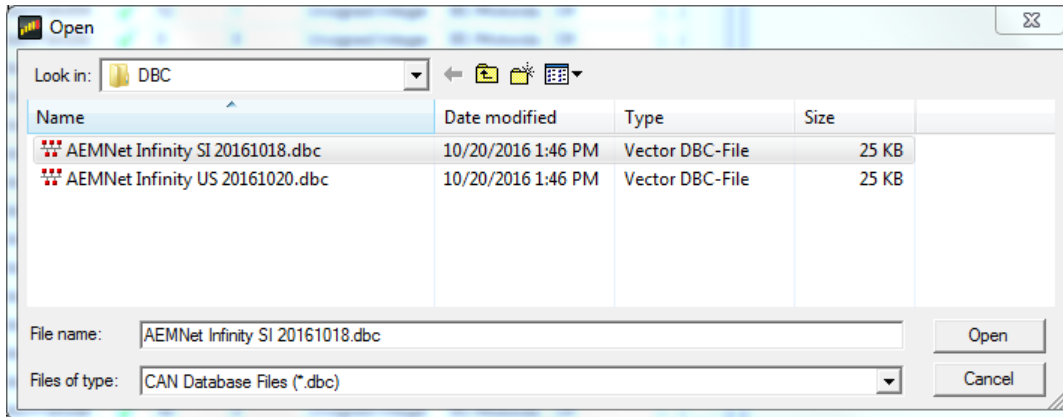

Available .dbc files will be located in the \Documents\AEM\DashDesign\DBC folder. Selecting a file will open the import dialog.

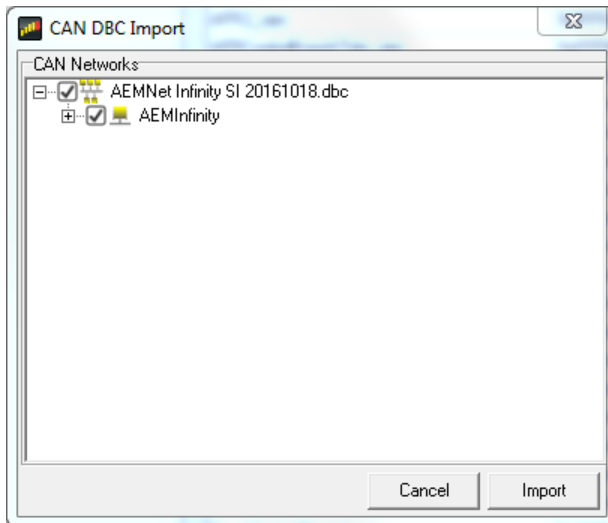

The levels can be expanded by clicking on the plus symbol.

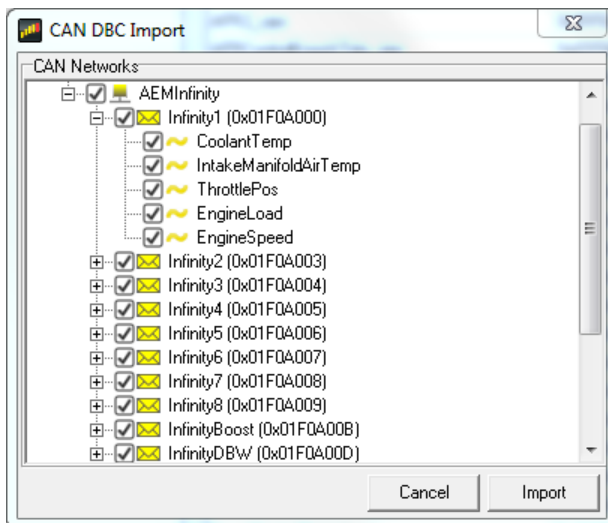

Select the channels for import by clicking the boxes. All available channels are selected by default. Click the Import button to import. All CAN message information is automatically imported along with necessary Scalar and Bit string operations. The channels are now available for assignment.

## Logging (CD-7L only)

AEM CD-7 / CD-7L has 200Mbytes of internal data logging memory and supports logging rates of up to 100Hz. Data is downloaded and analyzed with AEMData Analysis software.

To configure logging, select **Setup | Logging** to show the log setup window. Channels available to be logged are shown on the left hand side. To log a channel, select the desired rate from the Log Rate column. Logging a specific channel also automatically selects all other children and parent channels for logging at the same rate.

AEM CD-7 / CD-7L inserts markers in the data to indicate various states and these are displayed in AEMData. The following markers may be inserted by AEM CD-7 / CD-7L:

- **Lap** - This is inserted when the beacon input is triggered and is typically used for lap timing.
- **Power** - This is inserted when the display is configured to start logging immediately on power up.
- **Log Start** - This is inserted when the log start condition is met after power up
- **Overrun** - The display has been unable to write the log data to the memory in the time available. Either reduce the number of logged channels or reduce the complexity of the display screen.

The logging can be started or stopped dependent on channel conditions. Every time a new log is started, a new *Log Run* is created in the logger. Log runs can be downloaded individually with GEMS Data Analysis which reduces the time taken to download the data.

The log can be started in one of three ways:

- **Single input start/stop** - When the specified input is non zero, the log will be started. When zero, the log will be stopped. For example, if the channel EngineSpeed is used as the trigger, the logger will log anytime the engine is running.
- **Twin start/stop triggers** - When the Start trigger is non zero, the log will be started. When the Stop trigger is non zero, the log will be stopped.
- **Log Always** - The logging starts logging immediately on power on and will log until switched off or until the log is full.

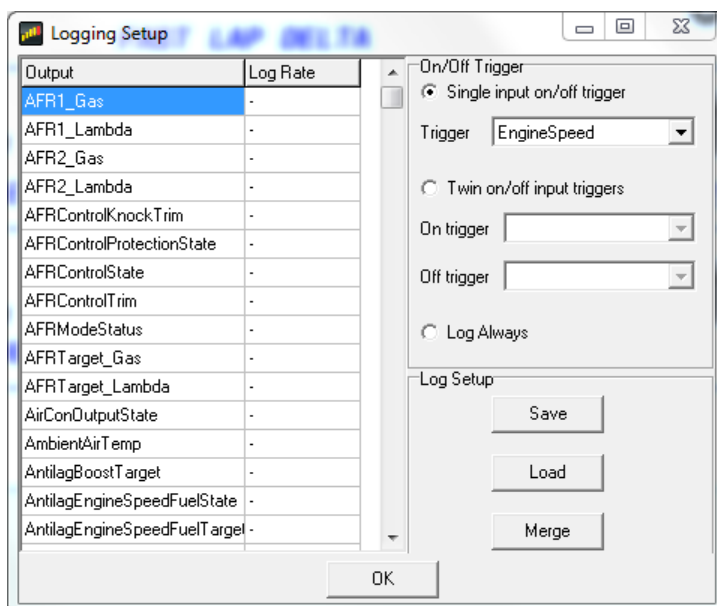

Enabling logger adds the following special outputs:

- **Log Mem Total** - The total logging memory in kilobytes
- **Log Mem Free** - The amount of logging memory remaining in kilobytes
- **Log Mem Percent Free** - The percentage of logging memory free.
- **Log Status** - A string representing the current logging status:

The Log Status string has the following meaning:

- **Logging not Supported** - This firmware does not support logging.
- **Logging stopped** - The device is not currently logging.
- **Logging running** - The device is currently logging.
- **Log looped** - The log has looped.
- **Log memory space low** - There is less than 5% of the log memory remaining.
- **Log memory full** - The logging memory is full and logging has stopped.
- **Log initialising** - The logger is currently processing the setup.
- **LOG SETUP ERROR** - There is a problem with the logger setup.
- **LOG OVERRUN** - The logger has been unable to write the log data to the memory. Either reduce the number of logged channels or reduce the complexity of the display screen.
- **Log memory worn** - There are a significant number of bad blocks in the flash memory. Logging will continue to work but capacity will be reduced.

To download log files from an AEM CD-7L, connect the USB cable between the dash and your PC. Launch AEMData analysis software and turn on the switched ignition power to the Dash. The message below will be displayed when AEMData detects a connection to the dash.

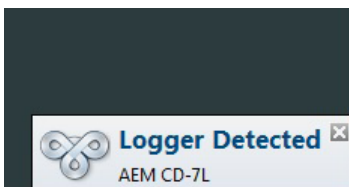

Go to **Logger | Download Log**

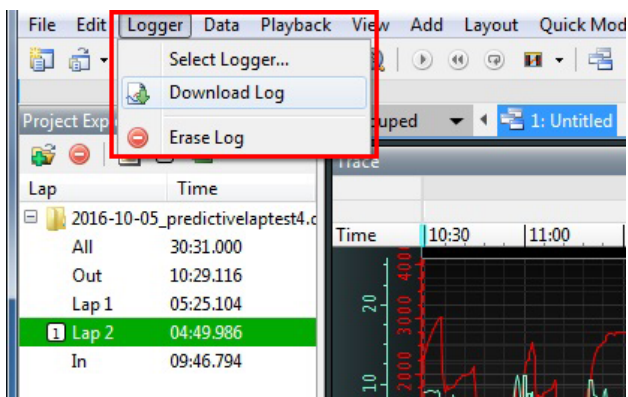

If there are logs saved on the dash, a list similar to the one below will be presented. Select the files to download. Choose whether to erase the files from the dash or not.

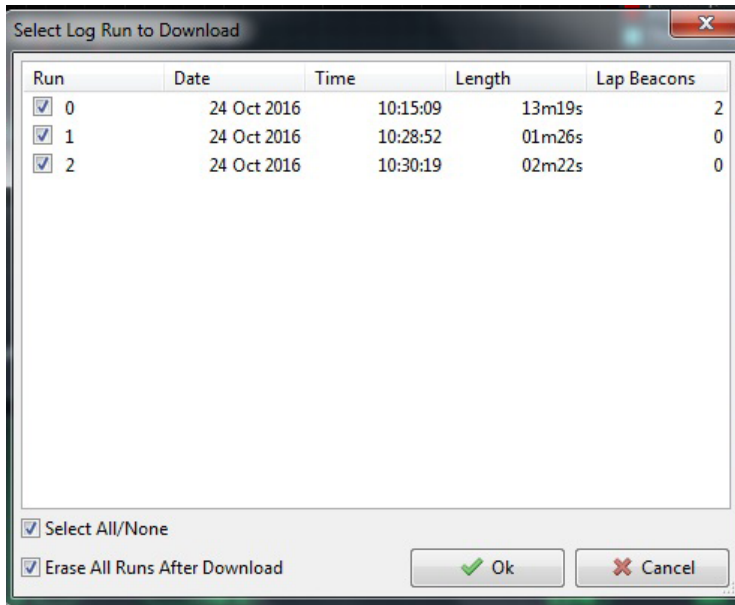

## Uploading a Setup to a Display

Uploading a setup programs the current setup into the color display.

AEM DashDesign communicates with the AEM CD-7 / CD-7L via USB.

To upload a setup:

- Open a display setup.
- Connect the AEM CD-7 / CD-7L to the PC using a USB cable. The AEM CD-7 / CD-7L will go into upload mode and will show "**USB cable connected**"
- Select **File | Upload Setup...** or press Ctrl + U
- A dialog box will appear indicating the setup is being sent
- On the AEM CD-7 / CD-7L, the upload progress will be shown as a percentage. This progress percentage IS NOT shown in the AEM DashDesign interface.
- Once the setup has been received the flash will be erased; the AEM CD-7 / CD-7L will show "**Erasing flash**". This process will take a few seconds.
- Once the flash has been erased, it will be programmed; the AEM CD-7 / CD-7L will show the progress of programming as a percentage. Do not remove the power to the display at this point.
- Once the programming has finished, an **Upload complete, OK to disconnect** message will be displayed as shown in the example below. Unplug the USB cable to reboot the dash with the new setup. Do not disconnect the USB cable before this message is displayed.

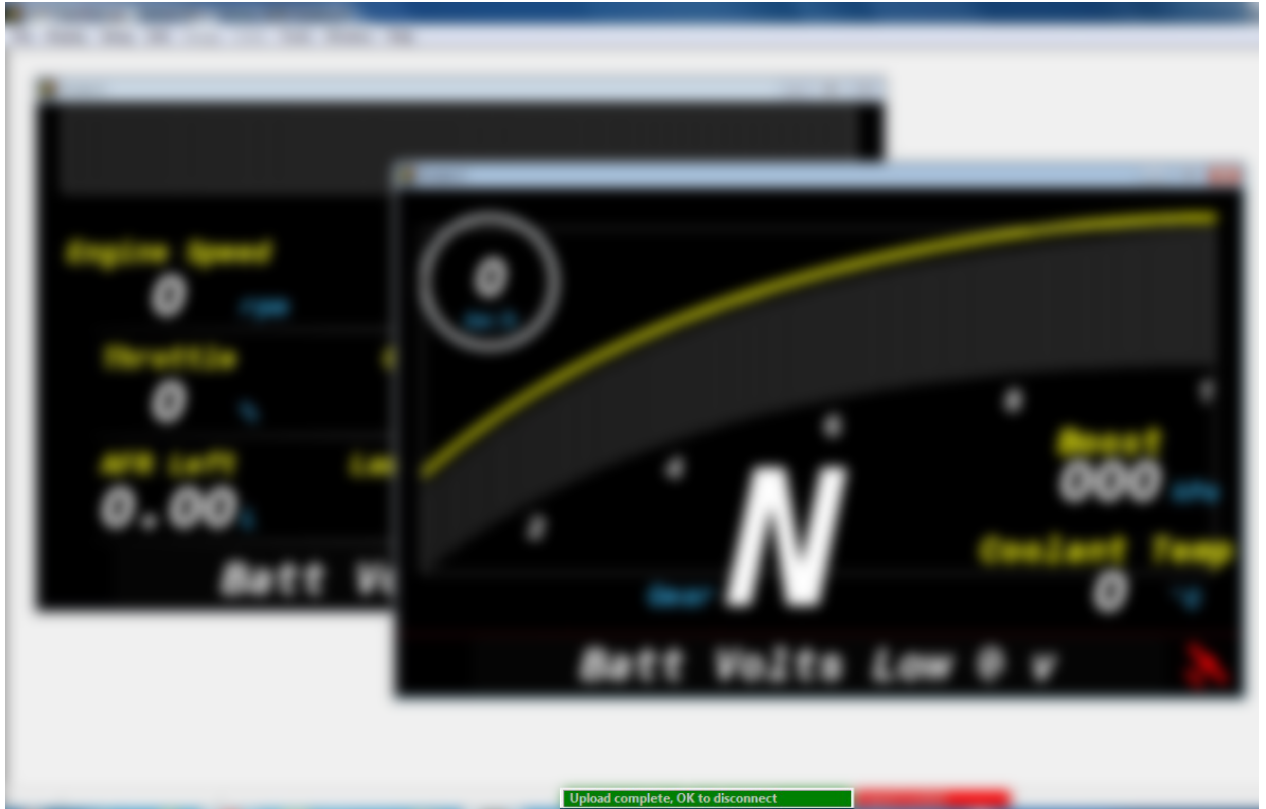

## Creating a New Display Setup

To create a new display setup:

- Select **File | New**
- Select **Setup | Display | CAN Receive**

## Updating Color Display Firmware

As part of the continuing development process, from time to time new versions of the AEM CD-7 / CD-7L firmware will be released with new DashDesign installers. To upload the new firmware:

- Firmware files are installed to the \Documents\AEM\DashDesign\Firmware folder.
- Connect the color display to your PC using the USB link..
- Select **Tools | Upload Firmware**. Select the firmware (.bin) file from the location above.
- The upload process starts. Do not switch the display off during the upload process as this may corrupt the firmware.
- Once the upload process has finished, unplug the USB cable to reboot the display.

---

## Part II - Advanced Setup

Part II contains more advanced setup information.

## The Setup Editor

The AEM DashDesign Setup Editor is used to configure the non-visual objects of a setup i.e. **Outputs** and **Operations**. Some outputs use more than one input depending on the operation used. The setup editor is accessed by selecting **Setup | Display....**

Each page of the editor has **Insert** and **Delete** buttons which are used to insert or delete an item in that tab. The following sections describe the various operation types available and how they are used to make an output.

### Outputs

Outputs are values, strings or bitmaps that are used by gauges or other outputs. The output that it passes is determined by the operation that it uses.

To set up a new output:

- Click the Insert button in the Outputs tab.
- Enter the name of the new output. This should describe what the output actually generates.
- Select the operation to be used by the output from the drop-down list.
- Select the input from the drop down list.

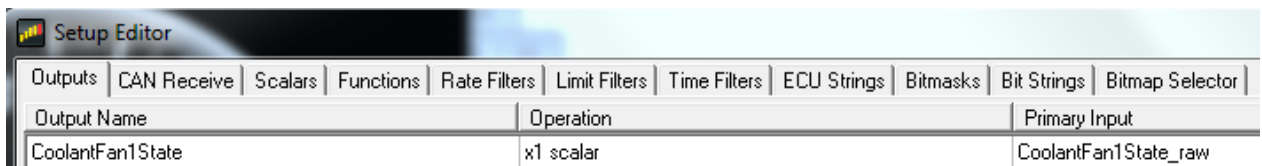

The example above shows the basic use of a x1 scalar. It uses a raw input and passes it through as itself with the opportunity to change the name.

$$\text{CoolantFan1State} = (\text{CoolantFan1State\_raw}) * (1)$$

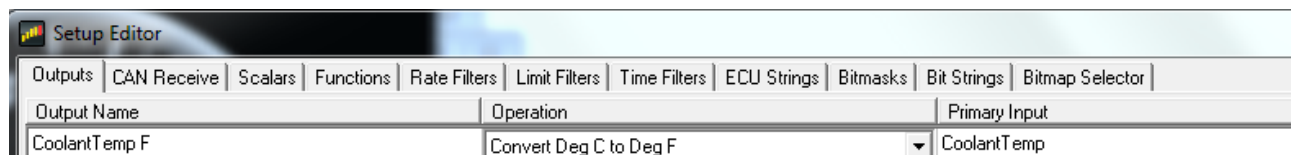

The next example shows a simple unit conversion operation.

Find the *Convert Deg C to Deg F* in the Scalars tab.

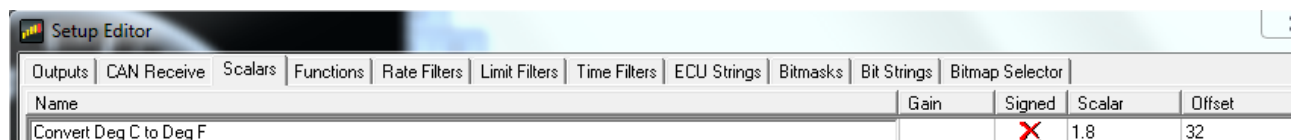

This Scalar operation uses a Scalar value of 1.8 and an offset value of 32. Applying this Operation results in the following math expression.



$$\text{CoolantTemp F} = (\text{CoolantTemp} * 1.8) + 32$$

This is a simple unit conversion for converting degrees C to degrees F.



Output Name	Operation	Primary Input
EngineProtectionState_string	EngineProtectionState_bit string	EngineProtectionState_raw

The next example uses EngineProtectionState\_raw as the Primary Input. This input has two possible values which are 0 or 1. A Bit String operation is used to convert these values into text strings that can be displayed on the dash.

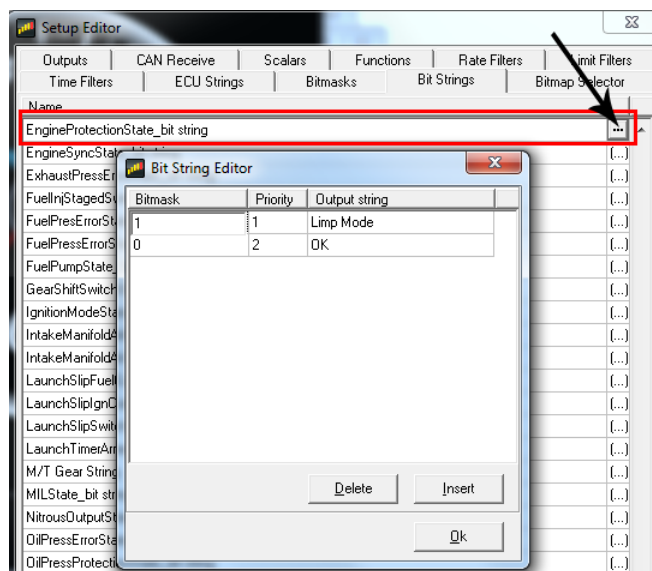

Shown above, the Bit String operation performs the following transformation:

If EngineProtectionState\_raw = 1, EngineProtectionState\_string = Limp Mode

If EngineProtectionState\_raw = 0, EngineProtectionState\_string = OK

## CAN Receive

The CD-7 is a CAN display dash. The CAN receive tab of the Setup Editor must be defined for proper functionality. The steps involved in defining a CAN message structure from scratch is outside the scope of this manual. However, the system includes a robust CAN .dbc import feature that greatly simplifies the process.

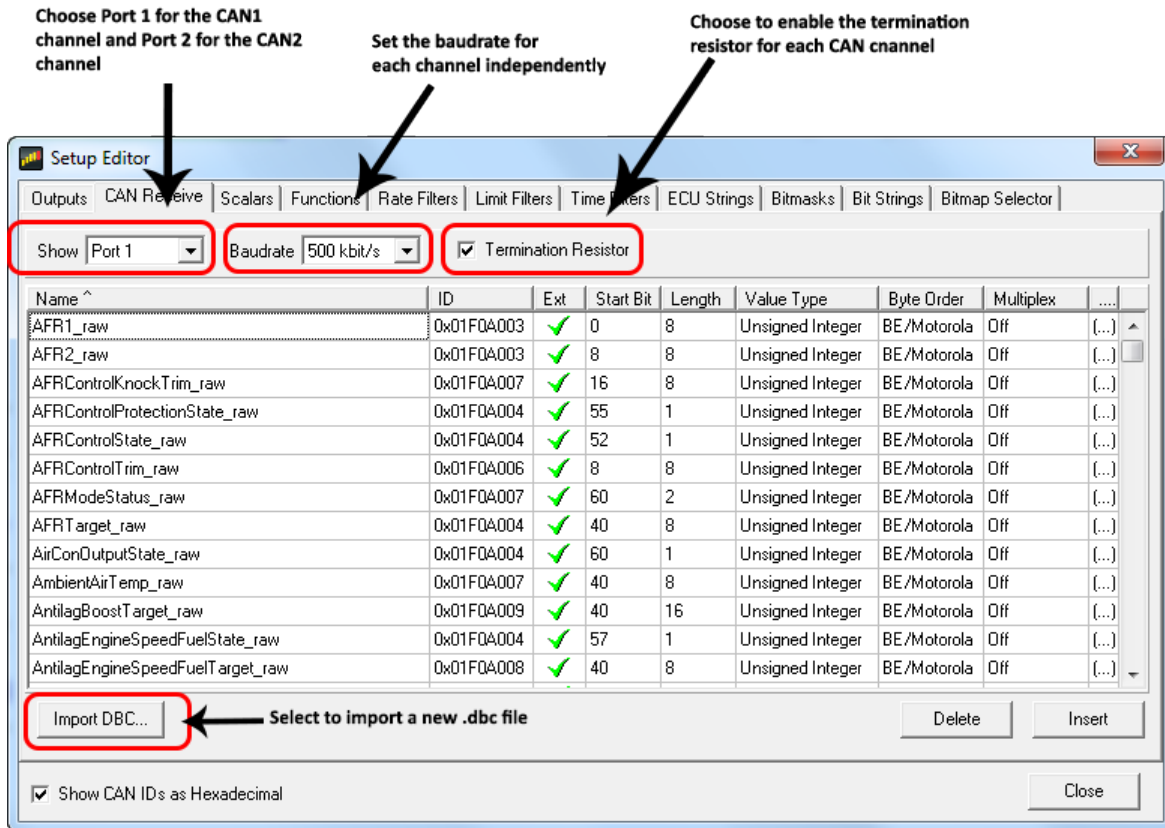

The "Start Bit" refers to the location of the LSB. The message contents and the byte/bit numbering can be viewed by clicking on the ... button for each message.

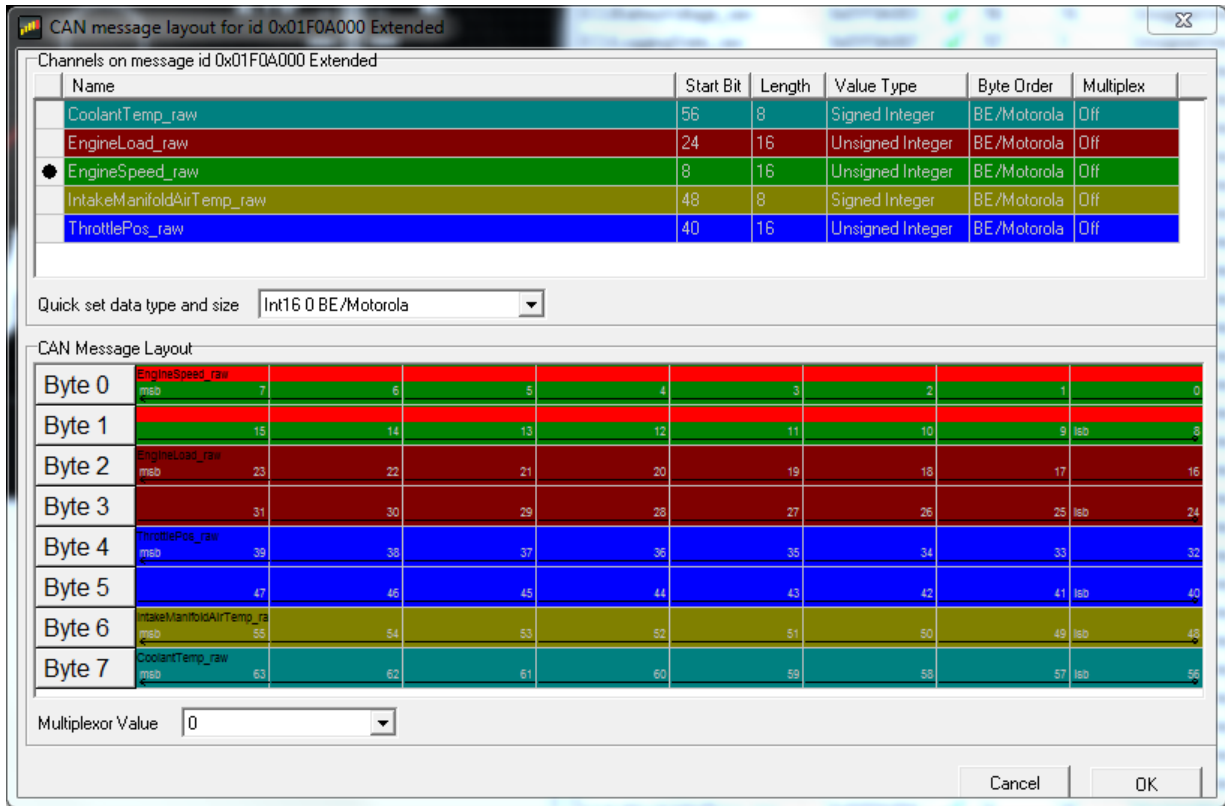

## Scalars Operation

The scalar sensor applies a gain (if specified) to the input which is then multiplied by the scalar and the offset added. If signed is ticked and the gain is not set to NONE, the input is treated as a twos complement number. The scalar sensor is used for linear signals.

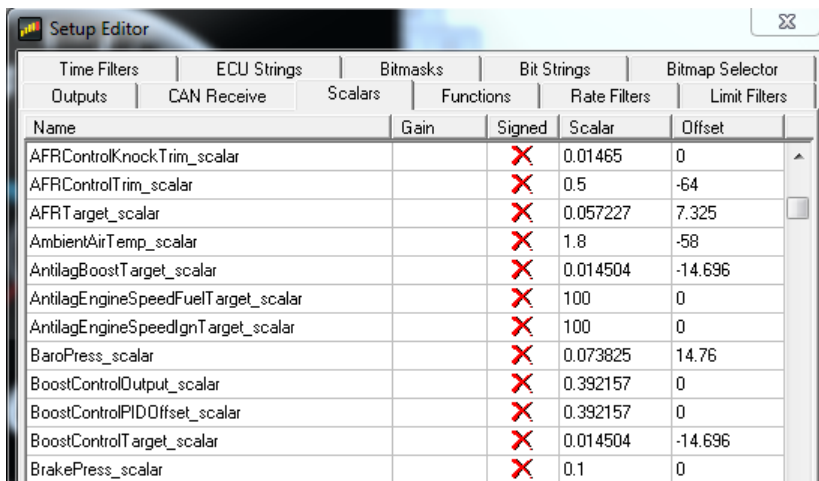

## Functions Operation

The function table sensor is used when a non-linear signal needs to be processed. The function table sensor applies a gain (if specified) to the input and looks up the input in the function table to produce the appropriate output. If the input falls between two values, linear interpolation is used to derive the output value. If signed is ticked and the gain is not set to NONE, the input is treated as a two's complement number.

To edit the function table, click the ellipsis button (...) to show the function table editor:

The values in the Input column must increase with each row.

## Rate Filters Operation

An output using a rate filter checks that the rate of change of the input value does not exceed a specified amount. If the rate of change is too high the new data is discarded.

## Limit Filters Operations

An output using a limit filter checks that an input value never exceeds specified levels, either high or low. This can be used to prevent invalid data from reaching other outputs or gauges. If data is received that exceeds either of the high or low values (if specified) the data is discarded.

## Time Filters Operation

Normally, outputs send data to gauges as fast as possible. However, by creating an output using a time filter operation, it is possible to specify the update rate of the output which is useful for making rapidly changing values more legible. Furthermore, a time filter operation can be used to perform a rolling average, minimum or maximum on the input value which is useful for filtering noisy inputs.

To edit the Time Filter operation values, click the ellipsis button (...) to show the time filter editor:

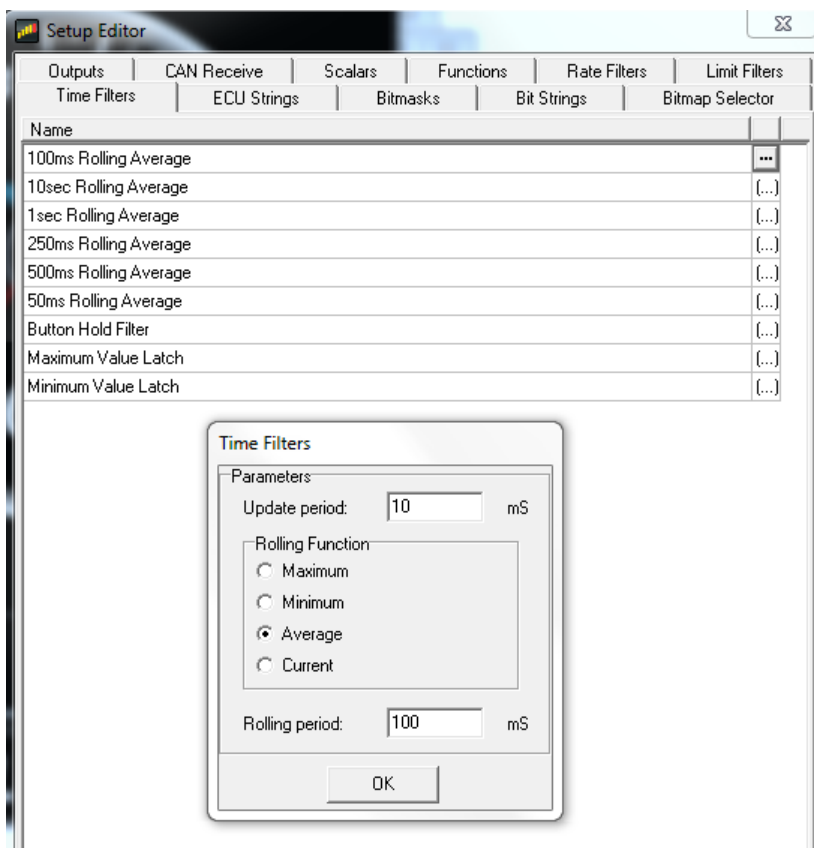

The Time Filter parameters have the following meanings:

- **Update period:** Specifies the rate at which values are sent to outputs and gauges used by this output. For example, if the Update Period is set at 1000, a gauge displaying the value from this output will update once per second. If 0 is specified, the output will update as fast as possible.
- **Rolling period:** Specifies the time period over which the rolling function is calculated. If zero is specified, the rolling period is set to the update period.
- **Rolling function:** Specifies how the value produced from the output is calculated:
  - **Maximum:** The output is the maximum value occurring during the last (rolling period) milliseconds.
  - **Minimum:** The output is the minimum value occurring during the last (rolling period) milliseconds.
  - **Average:** The output is the average of all values occurring during the last (rolling period) milliseconds.
  - **Current:** The output is the last received value. This effectively disables the rolling period function.

## ECU Strings Operation

An output using an ECU String operation is used to obtain a text string (such as a calibration name) from the connected ECU. The length of the string to obtain is specified in the length column.

## Bitmasks Operation

The bitmask operation is used to mask off bits from a raw (32 bit) input. This is useful when data is received from the ECU that contains information for two different outputs. For example, the lower 4 bits of a value may be used to determine gear position while the upper 4 bits determine diff mode. The bitmask is specified as the sum of all the bits being masked.

## Bit Strings Operation

When an input has bits that are set dependant upon a mode in the ECU, it can be useful to convert this into a text string output. The bit string operation takes the input and compares it with defined bitmasks. The bitmasks are compared in order of priority until the masked input is set or no more bitmasks are defined. If a masked input is set, the corresponding output string is passed out of the sensor. If no bitmask matches the input an empty output string is passed.

To create a bit string operation, add a name for the operation in the Bit String tab and click on the (...) button to show the bit string editor:

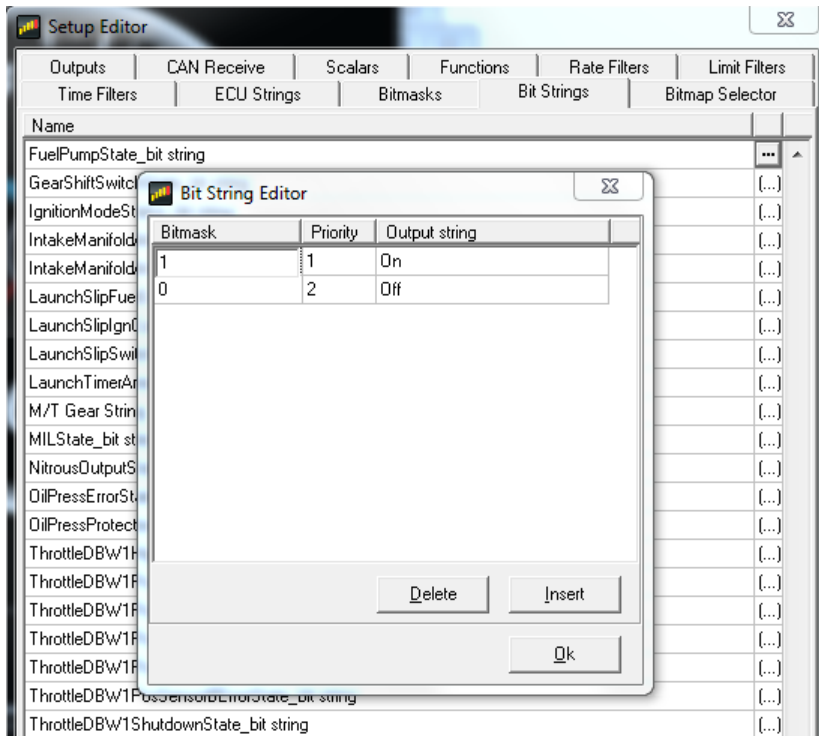

The priority determines the order in which the bitmasks are evaluated with low numbers being a higher priority. This ensures that if two bitmasks match, only the highest priority output string is returned from the sensor.

### Bitmap Selector Operation

The bitmap selector operation is used to show different bitmaps depending on the value of an input. To create a bitmap selector operation, add a name for the sensor in the Bitmap Sel tab and click on the (...) button to show the bitmap selector editor:

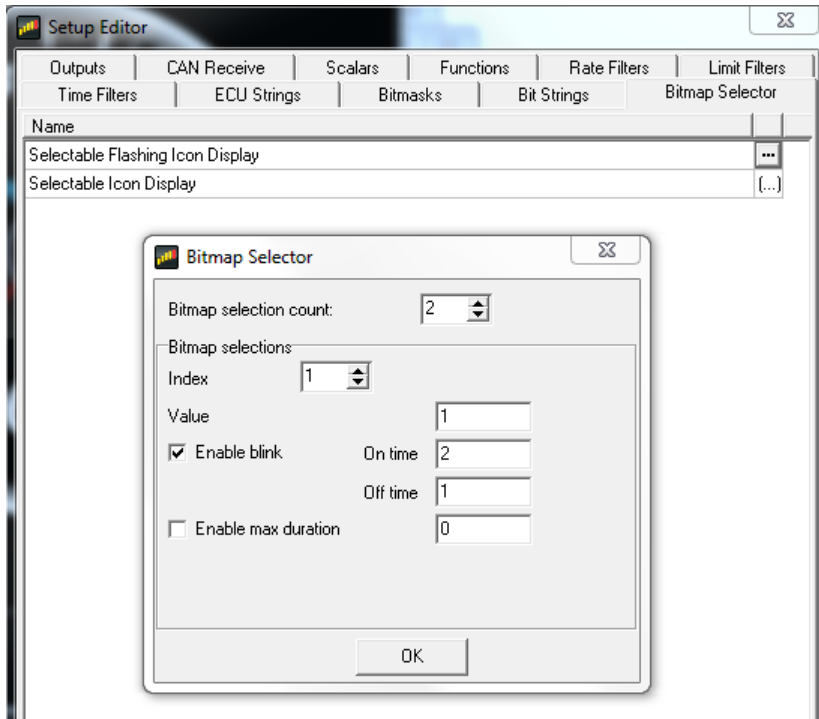

The bitmap selection count is the number of bitmaps used in the sensor and is at least two. The first bitmap is shown by default. Subsequent bitmaps are shown according to the settings in the Bitmap Selections box.

- **Index** - The number of the selection bitmap for which the following settings are made. For example, if the selection count is set to 3, 1 will specify the first selectable bitmap and 2 will specify the second selectable bitmap.
- **Value** - When the input (specified in the output) is equal to this value, this bitmap is shown instead of the default bitmap.
- **Enable Blink** - If checked, this bitmap will blink according to the **On Time** and **Off Time** in seconds. The bitmap swaps between the indexed bitmap and the default bitmap.
- **Enable Max Duration** - If checked, the bitmap is only be shown for the specified duration no matter how long the input is equal to the value.

## Alarm Operation

To create a new Alarm output, push the Insert button in the Outputs tab of the Setup Editor.



Assign the output a new name and choose *Alarm* from the dropdown list of available Operations. Push the  button under the Primary Input column for the new Alarm Output. This will open the Alarm Output Setup window. The new name will automatically be added to the Alarm Output Name box.

Alarm Output Setup

Alarm Setup

Input	Condition	Limit	Logic
	<	0	-

Alarm Output Name: Lean Warning

Alarm Timeouts

Delay Before Trigger / s: 0.00      Retrigger After / s: 0.00

Buttons: Delete, Add, Cancel, OK

Select an Input from the drop down list along with Condition and Limit selections.

Alarm Output Setup

Alarm Setup

Input	Condition	Limit	Logic
AFR1_Gas	>	15	-

Alarm Output Name: Lean Warning

Alarm Timeouts

Delay Before Trigger / s: 0.00      Retrigger After / s: 0.00

Buttons: Delete, Add, Cancel, OK

In the example above, the Input AFR1\_Gas is checked against a maximum condition of 15:1 AFR. Click the Add button to add additional criteria.

Alarm Output Setup

Alarm Setup

Input	Condition	Limit	Logic
AFR1_Gas	>	15	AND
EngineSpeed	>	0	-

Alarm Output Name: Lean Warning

Alarm Timeouts

Delay Before Trigger / s: 0.00      Retrigger After / s: 0.00

Buttons: Delete, Add, Cancel, OK

Above, the input EngineSpeed is added as an "AND" condition with a limit of 0 RPM. With this logic, IF AFR1\_Gas is greater than 15 AND EngineSpeed is greater than 0 (engine running), the alarm will trigger.



The Retrigger value specifies a timeout in seconds after which the alarm (if still triggered) will toggle to untriggered and back to triggered. This is useful for when an alarm has been used to trigger a page change, usually showing a warning to the driver, for example, low oil pressure. The driver can select the standard page again to cancel the alarm. If the oil pressure is still low after the specified period, then the warning page will be shown again.

If the retrigger value is set to zero, then the alarm will only retrigger if the input conditions change to false and back to true again.

The logical expressions are evaluated from top to bottom and the running result of the logical test is used as the input for the next logical evaluation.

## Warning Message Operation

An output using a warning message operation is used to output warning messages when inputs are outside of the normal operating range.

- The warning input typically uses an output defined with an alarm operation. If the value of the output is non-zero, the associated warning message will be displayed.
- The label input is optional and is used to provide a value to be shown in the warning message.

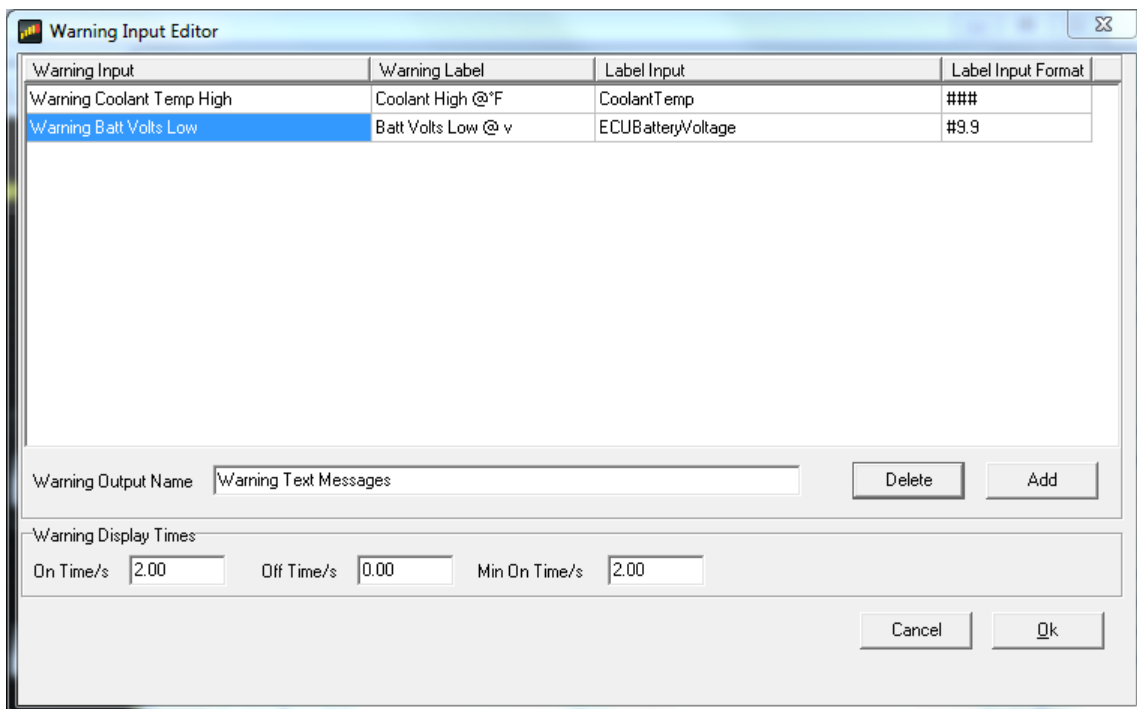

The example above shows two existing Warning Inputs. These were both previously defined as Alarm outputs before setting up this window.

The Warning Editor message is entered in the Warning Label column. When an '@' symbol is inserted into the warning label a formatted input value from the label input replaces it in the display. The Label Input defines the data that replaces the '@' symbol. The input label format column allows the format of the value from the label input to be defined. For full details on value formatting, see Value Formatting in the gauge reference section.

If all the warning inputs are zero, the output string is empty. If only one warning input is non-zero, the appropriate warning is displayed. If multiple warning inputs are non-zero, the appropriate warning labels are displayed in turn, with each one being displayed for around a second.

The On Time, Off Time and Min On Time can be used to affect how the warning is displayed when only one warning is active and are scaled in milliseconds. For example, to have a single message flash at 2Hz, set the On Time to 1000 and the Off Time to 1000. Setting the Off Time to 0 disables flashing.

The Min On Time can be used to ensure a warning is visible even if it is only briefly triggered. For example, a low oil pressure alarm triggered during cornering may only occur for a fraction of a second but by setting the Min On Time to 2000 ensures that the message is displayed for 2 seconds and so is more likely to be seen.

## Odometer and Turn Blinkers

AEM CD-7 / CD-7L has a built in odometer function. This is an internal counter backed up to non-volatile memory that cannot be reset (it is set to zero when the unit is built).

To set up the odometer, choose **Setup | Odometer**. Select an output that is road speed km per second. AEM DashDesign will automatically create an output called **ODOMETER** which is scaled in km and can be displayed on the screen.

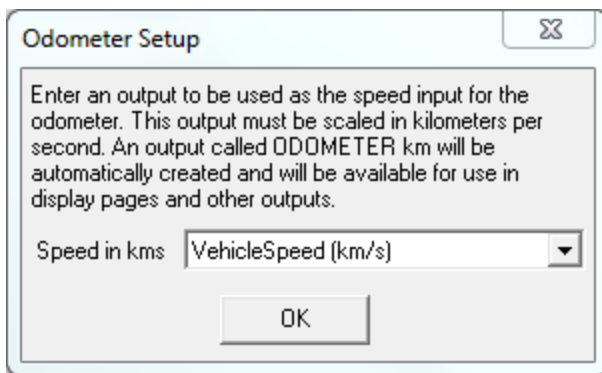

All AEM base setups include an odometer scaled in both miles and kilometers.

An optional turn blinkers feature is available on some AEM supplied setups. Pins 11 and 12 can be used for LEFT TURN and RIGHT TURN blinkers respectively. When these inputs are grounded, the turn blinkers will activate.

### HARNESS 12 WAY CON PINOUT

PIN	COLOR	DESCRIPTION
1	RED	SWITCHED POWER
2	BLACK	GROUND
3	WHITE	CAN1+
4	GREEN	CAN1-
5	GREY	CAN2+
6	BLACK	CAN2-
7	BLUE	PAGE UP
8	YELLOW	RESET/ACK
9	GREY	NIGHT MODE
10	VIOLET	BEACON
11	NA	SPARE1
12	NA	SPARE2

## Lap Timing and Track Mapping

The following channels are used for lap timing and track mapping.

Output Name	Operation	Primary Input
GPS_Course	GPS_Course_scalar	GPS_Course_raw
GPS_DayUTC	x1 scalar	GPS_DayUTC_raw
GPS_HoursUTC	x1 scalar	GPS_HoursUTC_raw
GPS_Latitude	x1 scalar	GPS_Latitude_raw
GPS_Longitude	x1 scalar	GPS_Longitude_raw
GPS_MinutesUTC	x1 scalar	GPS_MinutesUTC_raw
GPS_MonthUTC	x1 scalar	GPS_MonthUTC_raw
GPS_SatelliteCount	x1 scalar	GPS_SatelliteCount_raw
GPS_SecondsUTC	x1 scalar	GPS_SecondsUTC_raw
GPS_Speed	GPS_Speed_scalar	GPS_Speed_raw

Most AEM default setups include a lap timing screen. The VDM for GPS speed and lap timing section describes the basic setup and configuration of a GPS input for speed and position. Once configured, the screen will update with current data as the laps progress.

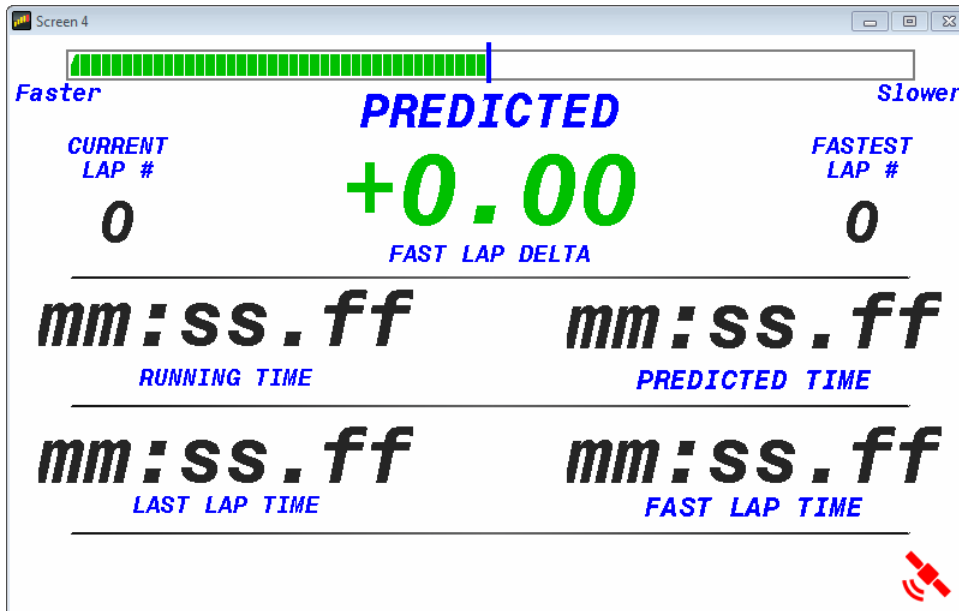

Lap Timing channels available include:

- Fastest lap number
- Fastest lap time
- Fastest lap average speed
- Fastest lap time delta (your current lap compared to the fastest lap)
- Last lap number
- Last lap time
- Last lap average speed
- Last lap time delta (your current lap compared to the last lap)
- Current lap number
- Current lap time

Go to **Setup | Lap Timing...** Select the GPS button to configure for GPS lap timing. A virtual start/finish line creation feature allows you to use the beacon input (violet wire in flying lead harness) to set a virtual start/finish line. While driving the course, press the momentary beacon switch when you cross the start/finish line. Hold for a few seconds until the left and right LEDs flash. The system captures the location information when you first press the button. Holding for a few seconds eliminates the likelihood of false triggering the input. You can define your virtual track width in the dialog window. Set to the approximate width of the track surface plus some extra. The dash creates a start finish line the width of the Track Width/m setting perpendicular to the heading when the start finish is set. It then checks whether the previous two points cross this line; the only caveat being that the heading is +/- 90 degrees of the original heading.

The GPS start/finish reference and fastest lap data is saved to non volatile memory in case the vehicle power is interrupted during operation.

Once your file that contains GPS data is added to an AEMData project, you can add a track map to your project. Go to **Add | Track** and select a spot on your layout.

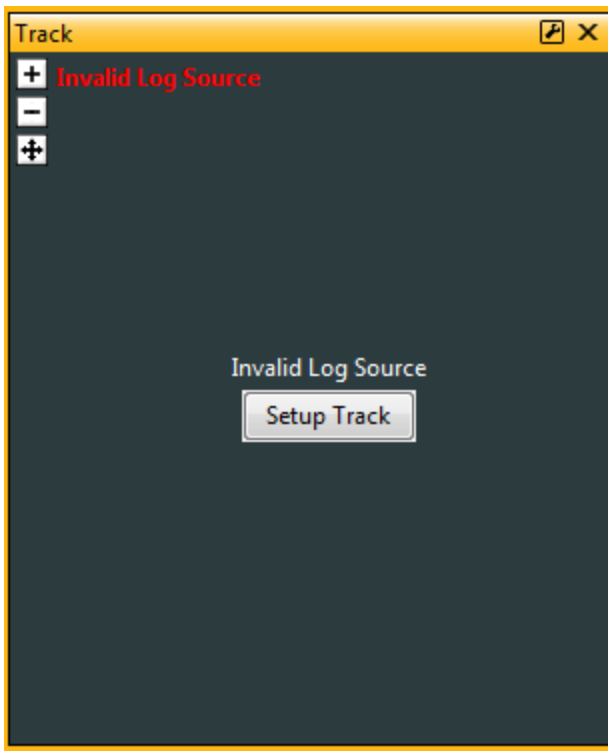

Click the Setup Track button and choose the GPS tab to configure your track.

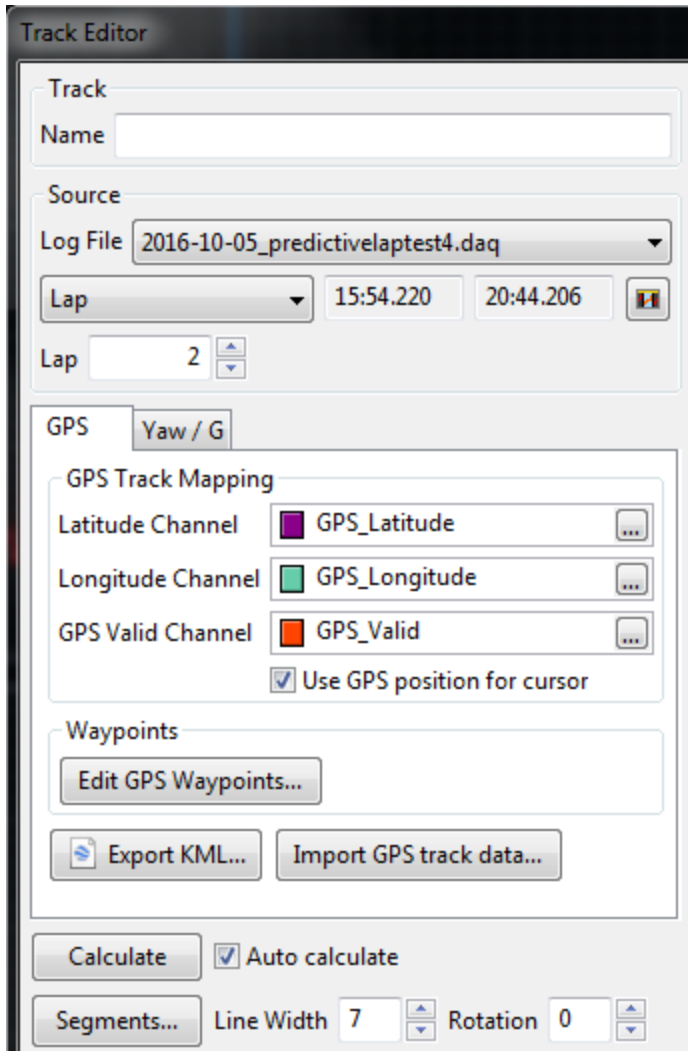

More details on Track Editing can be found in the AEMData documentation.

## CD-7 & CD-7L Settings

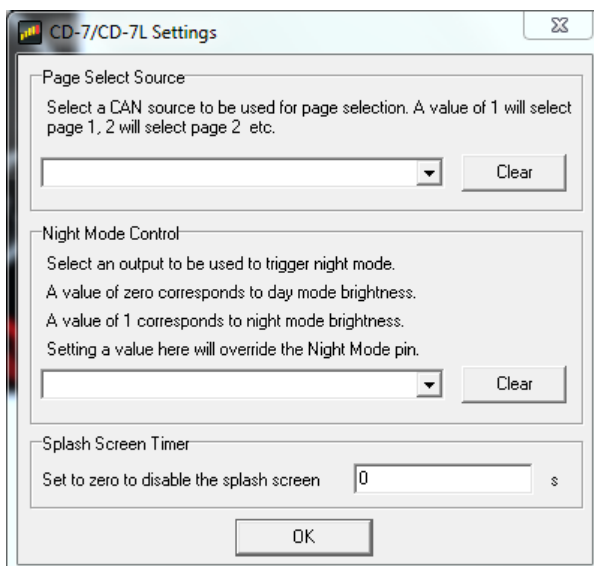

The Settings dialog will be populated correctly with all AEM supplied setup files. The options can be changed for custom setups. Night mode dialog box should be empty unless you want to control the mode via CAN. Default is empty and controlled by the flying lead harness input.

## Shift Lights & LEDs

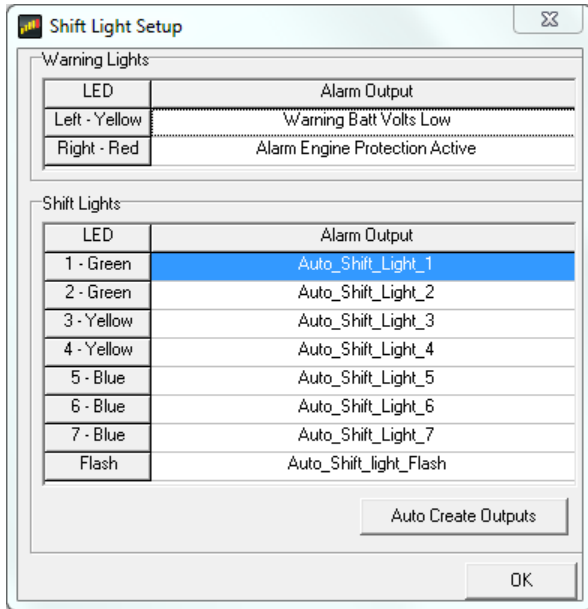

The LED and shift light setup will be pre-configured with AEM supplied setup files. The Alarm outputs used to trigger the LEDs can be adjusted in the Setup Editor as shown in the example below.

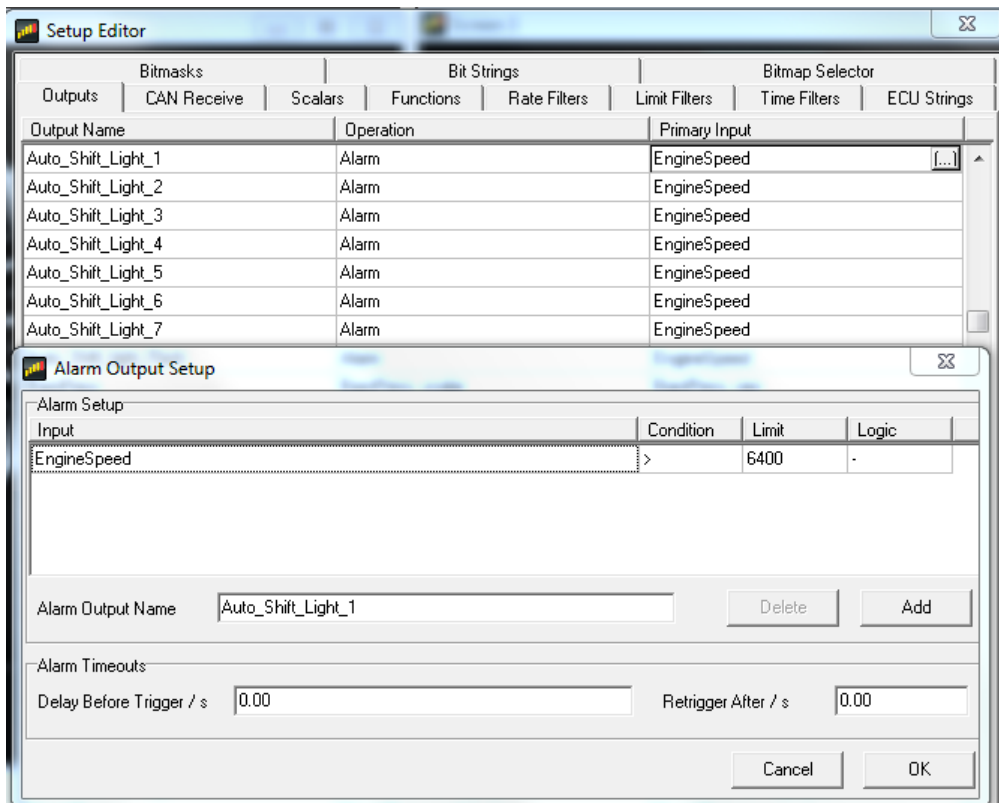

## Alarm Page

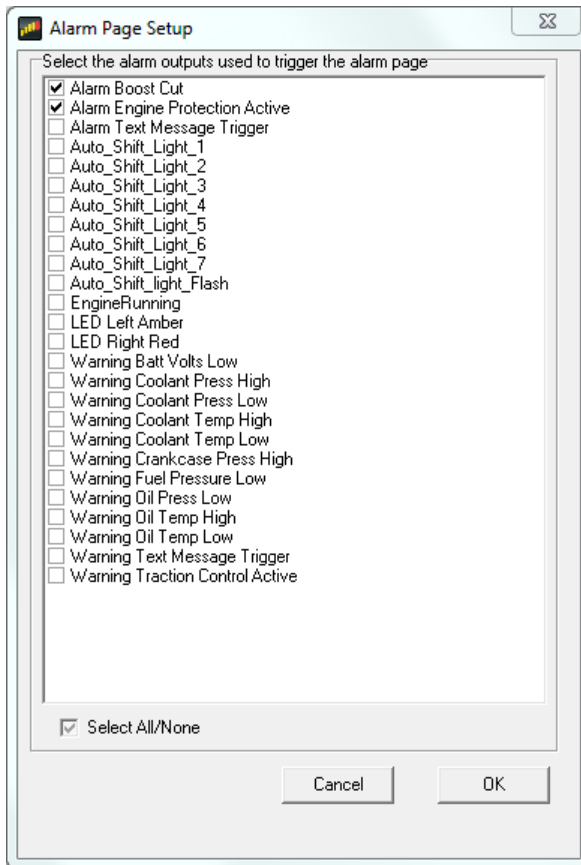

AEM setups will come pre-configured with many optional Alarm outputs. Choose the ones you want to trigger the Alarm Page.

## On Change Page

The On Change Page allows you to setup a custom page that will be displayed when any changes are detected on selected channels. The list of available channels will be displayed at the left. Double click or press the space bar to move them to the right Selected Channels list.

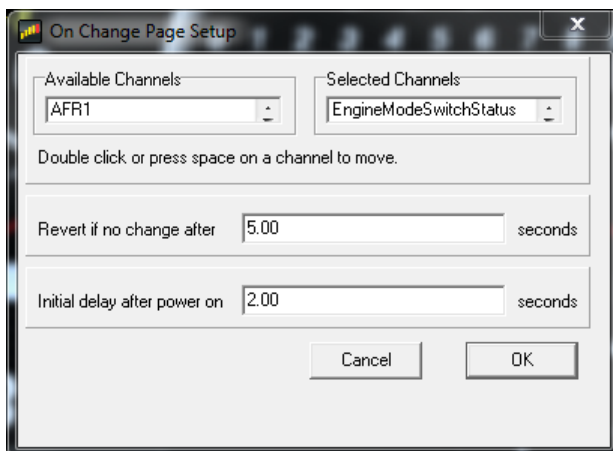

The example below shows one version of an AEM supplied On Change Page. Different operating modes and/or multi-map selections can be displayed using this page. Other useful items are boost target and traction controls set points.

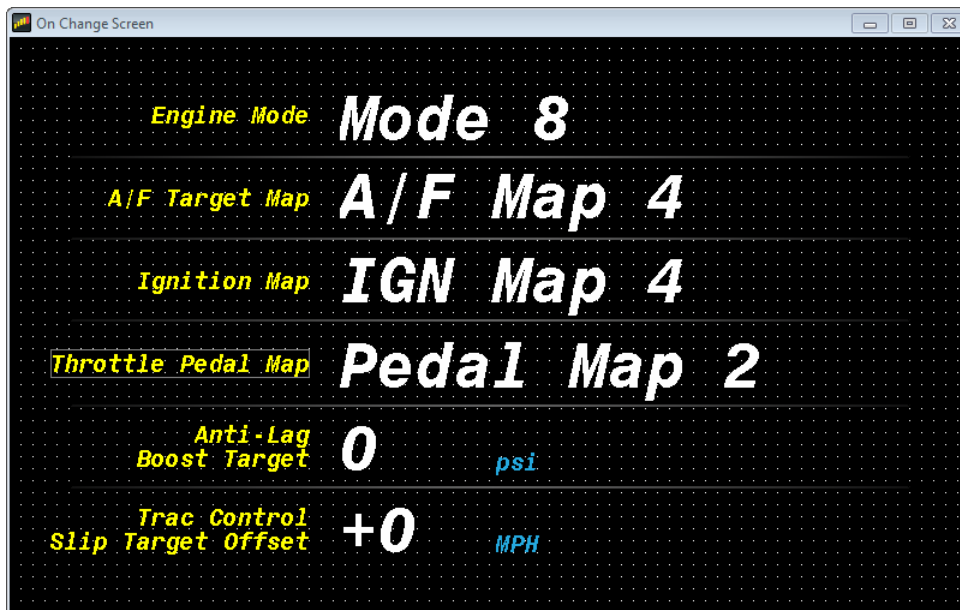

## Brightness

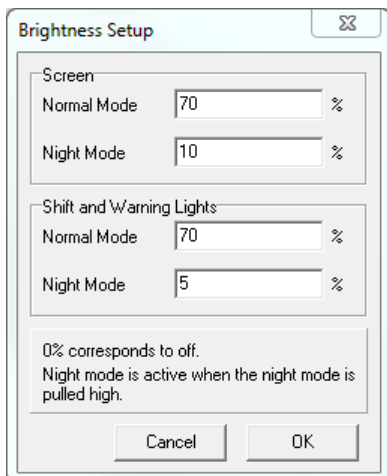

The Brightness setup dialog allows you to choose two different brightness settings for both the screen and LEDs. See CD-7 Harness and Wiring section for Night Mode input wiring. 100% should only be used in direct sunlight. 70% gives almost as much brightness without overdriving the backlight. 5%-10% is appropriate for night mode.

## Display Screens

The AEM CD-7 / CD-7L supports 6 screen pages. The display also has a monitor list which enables permanent monitoring of data and a splash screen that appears when the display starts.

## Display Scaling

By default, AEM DashDesign displays the screens at actual screen size (100%). For example, if the screen size of the hardware is 800x480 pixels, then the screen editor windows will also be 800x480. Editing in this mode provides a true what you see is what you get editing experience.



However, it is possible to show the editor windows at different scalings by selecting an appropriate value from the **Display | Display Scale** menu. Supported scales are 75%, 100% (default), 125%, 150%, 175% and 200%.

## The Monitor Screen

Normally a given output is only monitored if used by a gauge on the currently displayed screen. In certain circumstances however, it is necessary to monitor some outputs irrespective of whether or not they are used by the currently displayed screen page. For example, if the maximum coolant temperature is required as an output for some screens, switching screens deletes the output as the screen changes and recreates it if necessary. The maximum output is then be reset and its' information is lost. By adding this output to the monitor page it is created when the color display is switched on. Changing screens has no effect on the output and the data is not reset unless a reset signal is received.

Furthermore, outputs added to the monitor screen are automatically stored in non-volatile memory. Thus, the value of a min, max or average output added to the monitor screen is preserved even when the screen is powered off.

Select **Display | Monitor** to view the monitor screen setup. Add the outputs to be continuously monitored to the list.

## The Splash Screen

The splash screen is a special screen that is shown for a set period when the display starts; for showing a team logo for example.

To design the splash screen, go to **Display | Splash Screen** and design the screen layout as normal. Typically, this will just be a logo but other static values (such as the serial number or version details) will work as well.

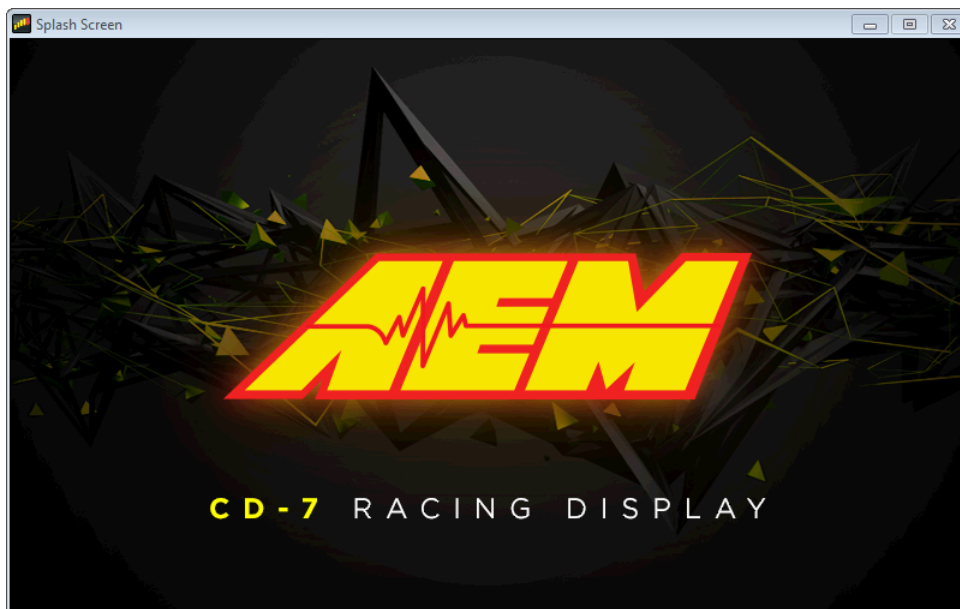

## Setting Screen and Default Colors

The **color** menu allows the default colors to be specified. These are used whenever a new gauge is added to a screen. The default colors can be overridden in the individual gauge properties.

- **Screen** – Sets the background color of the current screen.
- **Warning** – Default color of a warning bar when it is triggered.

- **Gauge Background** – Default background color of a gauge.
- **Gauge Line** – Default line color of a gauge used in drawing the outline.
- **Gauge Fill** – Default fill color of a gauge used in bars.
- **Gauge Text** – Default text color of a gauge.

## Adding a Gauge

Once a screen page is open, it is possible to add gauges to the screen. To add a gauge:

- Select the gauge required from the **Gauge** menu or the tool bar.
- Click on the area of the screen the gauge is to be added to and whilst holding the mouse button down drag a box to the size required for the gauge.
- On releasing the mouse button, the gauge will be added to the screen.

Most gauges can be added from the tool bar:

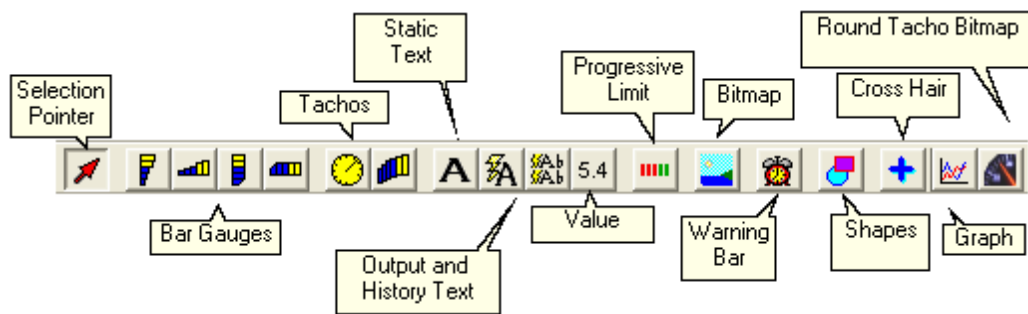

## Selecting a Gauge

A gauge is selected using either the mouse or keyboard. To select a gauge using the mouse, move the cursor over the gauge. If gauges are overlapping the topmost gauge is selected. Try moving the mouse to an area where the gauge to select is not covered by another gauge. Alternatively, use the keyboard. To select a gauge using the keyboard press the tab key repeatedly until the appropriate gauge is selected. When a gauge is selected a border appears around it.

## Moving a Gauge

A gauge can be moved using either the mouse or the edit window. To move a gauge using the mouse:

- Select the gauge with the mouse.
- When the cursor appears as a pointing hand  click and drag the gauge to the required position.

To move a gauge using the edit window:





- Show the Gauge Property window by right clicking on the selected gauge or by selecting it from the **Edit** menu.
- Change the values of the **x position** and **y position** properties to appropriate values.

This is particularly useful in aligning different gauges.

## Resizing a Gauge

A gauge can be resized using either the mouse or the edit window. To resize a gauge using the mouse:

- Select the gauge with the mouse.

- Move the cursor to the border of the gauge which requires resizing. The pointing hand cursor changes to a sizing cursor depending on the position:
  - If the cursor is at the top left or bottom right corner of the gauge the cursor changes to a NW-SE cursor  and is resized by dragging that corner.
  - If the cursor is at the top right or bottom left corner of the gauge the cursor changes to a NE-SW cursor  and is resized by dragging that corner.
  - If the cursor is at the top or bottom edge of the gauge the cursor changes to a N-S cursor  and is resized by dragging that side.
  - If the cursor is at the left or right edge of the gauge the cursor changes to an E-W cursor  and is resized by dragging that side

To resize a gauge using the edit window:

- Show the Gauge Property window by right clicking on the selected gauge or by selecting it from the **Edit** menu.
- Change the values of the **x size** and **y size** properties to appropriate values.

This is useful in making different gauges the same size.

## Deleting a Gauge

To delete a gauge:

- Select the gauge.
- Press the *Delete* key.

## Editing Gauge Properties

The gauge property editor is used to change the settings of an individual gauge. The gauge property editor is shown using either the mouse or **Edit** menu. Using the mouse:

- Select the gauge.
- Click the right mouse button.

To edit a gauge using the menu:

- From the **Edit** menu, select the name of the gauge to edit.

The gauge property editor is specific to the type of gauge being edited. See the Gauge Reference section for full details.

## Using Copy and Paste

The copy and paste feature is used to copy gauges or entire screens between screen pages or setup files.

- **Edit | Copy | Gauge** copies the currently selected gauge into the paste buffer.
- **Edit | Copy | Screen** copies the current screen into the paste buffer.
- **Edit | Paste | Gauge** pastes the last gauge copied into the paste buffer into the current screen.
- **Edit | Paste | Screen** pastes the last screen copied into the paste buffer into the current screen. Any gauges already present on the current screen will be removed.

To paste a gauge or screen into a different setup file, copy it, close the file, open the appropriate setup file and screen and paste.

## Setting the Gauge Z Order

When a page is rendered in the display, the gauges are drawn in the order in which they were added to the screen in the editor.

When gauges are placed on top of other gauges, it can be useful to change the order in which the gauges are drawn (the Z order). For example, if an alarm bar is added over a value gauge, only the alarm bar will be visible. By changing the Z order so that the value gauge is drawn after the alarm bar, the value gauge will appear drawn on the alarm bar.

To change the Z order on a page, select **Edit | Z Order...** or press **Ctrl Z**. The Z order editor will be shown. To change the order of a gauge, select it from the list (it will be simultaneously highlighted in the screen editor) and use the up and down cursor keys or the up down buttons to move the gauge within the list. gauges towards the top of the list are drawn first (behind other gauges). Gauges towards the bottom of the list are drawn last (in front of other gauges).

Click OK to commit the changes or cancel to quit the Z Order editor.

## Gauge Reference

Gauges are the visual elements of a AEM DashDesign screen page. The various different gauge types available in AEM DashDesign are described in this section.

### Standard Gauge Properties

Most gauges share a standard set of gauge properties described below. In addition to these standard properties, many gauges have additional properties that are described in their relevant section.

The standard gauge properties are as follows:

- **Name** - The name is used to identify the gauge in the **Edit** menu. AEM DashDesign assigns a name to a new gauge automatically although it is useful to give gauges more meaningful names as it makes them easier to identify in the **Edit** menu.
- **Input** - The output used by the gauge.
- **Minimum** - The value at which a gauge starts, for example the start value of a bar gauge.
- **Maximum** - The value at which a gauge finishes, for example the end value of a bar gauge.
- **Graticule Size** - Graticules or divisions are drawn at this frequency.
- **Label Frequency** - Labels are drawn at every **Label Frequency** number of graticules.
- **Label Font** - The font used by the gauge.
- **Label Font Size** - The font size used by the gauge.
- **Label Format** - Determines how numbers are formatted in the gauge. See the Value Formatting section for more information.
- **X Position** - The left most position of the gauge.
- **Y Position** - The top most position of the gauge.
- **X Size** - The width of the gauge.
- **Y Size** - The height of the gauge.
- **Background color** - color of the gauge background.
- **Line color** - color of the graticules and outline of the gauge.
- **Fill color** - color in which to draw a filled part of the gauge, for example the part of a bar graph that has data.
- **Text color** - color of all text in the gauge.

### Value Formatting

Many gauges can use a **Label Format** property in order to control how values are displayed. The following table shows the standard formatting characters that can be used.

Character	Description	Notes
X or x	Display in hexadecimal	Must be first character in format
B or b	Display in binary	Must be first character in format
-	Force leading sign character	e.g. +5.3 is displayed instead of 5.3
#	Indicates an optional digit	e.g. ### gives 93
9	Indicates a required digit	e.g. 999 gives 093
5	Indicates rounding to the nearest 5	e.g. ##5# gives 2450 instead of 2448
0	Indicates rounding to the nearest 10	e.g. ##0# gives 2400 instead of 2448
.	Indicates position of decimal place	

Gauges using time outputs use a different set of format strings:

- H - Displays the hours in 24 hour format.
- h - Displays the hours in 12 hour format.
- m - Displays the minutes.
- s - Displays the seconds.
- f - Displays tenths of seconds.
- ff - Displays hundredths of seconds.
- fff - Displays thousandths of seconds (only works for lap time via CAN).
- y - Displays the date in dd-mm-yy format
- z - Displays the date with text for the month, eg 01 Jan 09

Thus, the following formats would display the time in the following manner:

- Hms - 24:00:00
- hmsf - 12:00:00.0
- hmsff - 12:00:00.00
- y - 01-01-09
- hmsz - 12:00:00 01 Jan 09

System information can be shown by adding a value gauge to the screen and setting the **Label Format** property as follows:

- W - Shows the version of the color display firmware.
- vs - Shows the serial number of the display.
- vu - Shows the usage (on time) of the display in hours.
- vr - Shows the reset counter - the number of power on events since the last setup upload.
- vc - Shows the filename of the setup file used to program the display (up to 24 characters).

## Bar Gauges

There are four types of bar gauge - rectangle and triangle shaped bars in either horizontal or vertical orientation. A bar contains a number of graticules that divide the bar up between the minimum and maximum limits as shown in the diagram below:

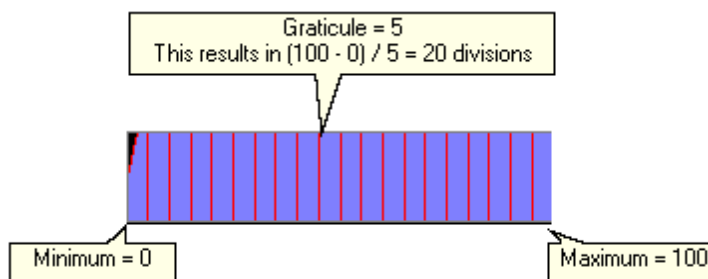

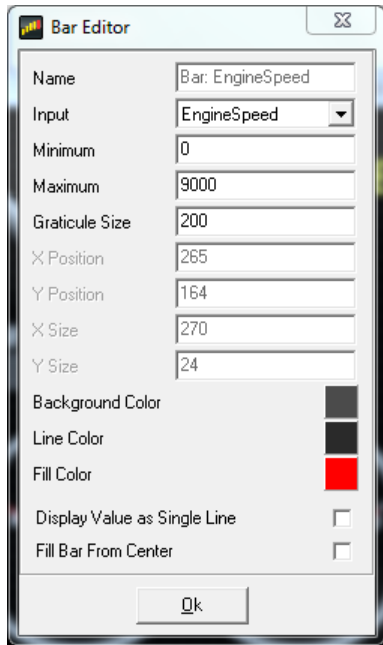

## Tacho Gauges

The tacho gauges are typically used with engine speed or road speed and are available as either a curved bar gauge or a round gauge. They use minimum, maximum and graticule size in the same manner as bars but also have labeled graticules, the frequency of which is specified by the label frequency property. The label values are divided by the label divisor property and then formatted. A typical bar tacho setup is shown below.

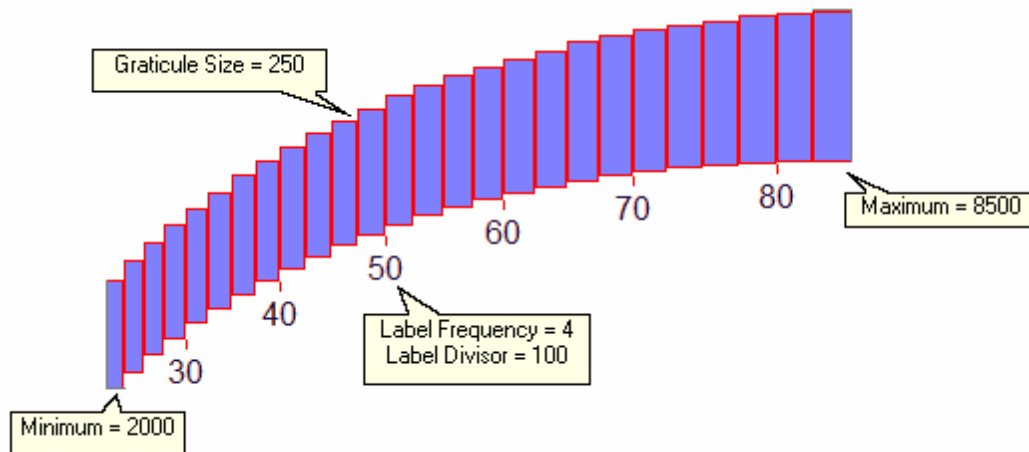

This bar tacho gauge has the following special properties:

- **Square Tacho** - If checked, the tacho will be rectangular instead of having an arc.
- **Enable Lower Tacho Limit** - Turns on the lower tacho limit. When enabled, the first part of the tacho (up to **Limit End**) is drawn in **Limit color** as it is filled. If **Enable Flash Below Limit** is checked, the lower part of the tacho will flash if the input value is below **Limit End**.
- **Enable Tacho Limit** - Turns on the upper tacho limit. When enabled, the last part of the tacho (after to **Limit Start**) is drawn in **Limit color** as it is filled. If **Enable Flash Above Limit** is checked, the upper part of the tacho will flash if the input value is above **Limit Start**.
- **Flash Entire Tacho above Limit** - If the upper limit is flashing because **Enable Flash Above Limit** is checked, all the filled tacho blocks will flash if this option is checked.
- **Flash Rate** - The rate at which to flash the tacho when in any of the flash modes.

It can be seen that with these options, the tachometer can effectively be divided into three separate different colored regions.

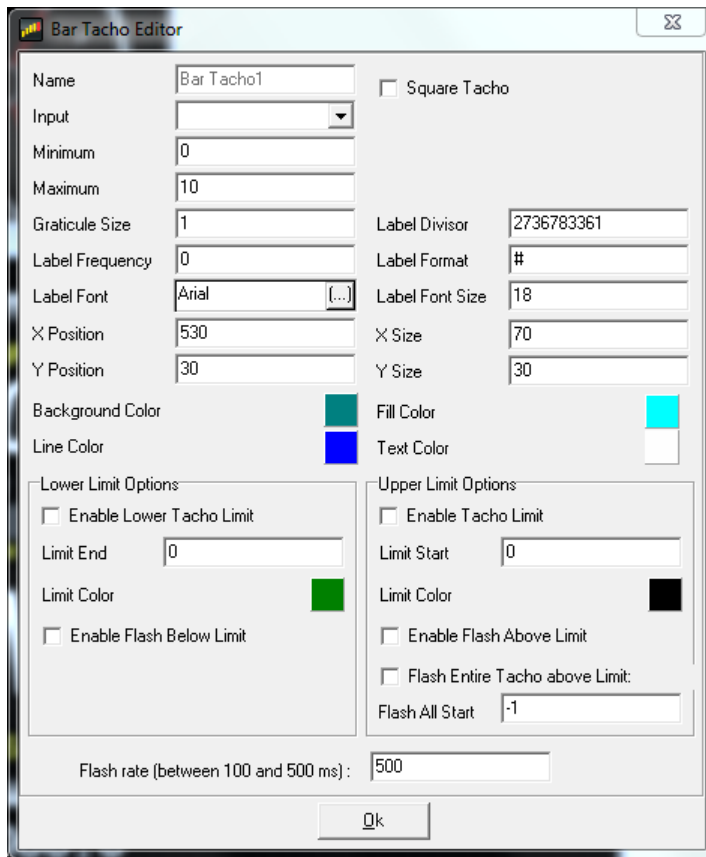

## Text Label Gauge

The Text Label gauge is a static gauge (it has no input) that is used to label other gauges and provide static information to the user. The text displayed in the gauge is set in the **Text** property. The **Direction** property is used to specify the direction in which the text is drawn in. *Right* specifies left to right. *Down* specifies top to bottom.

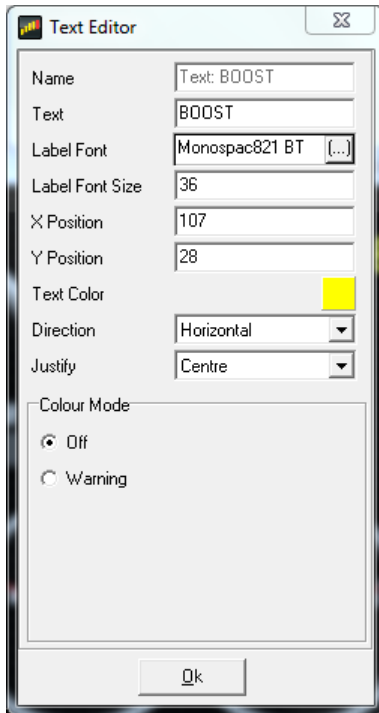

## Variable String Gauge

The variable string gauge is used to display text from a string output such as a bit string output. The **Justification** property specifies whether the text is aligned to the left, right or centre of the bounding rectangle.

**Note: It is important to select the background color of the value gauge to be the same as the color of the background the gauge is over. Failure to do so will result in corruption of the value displayed.**



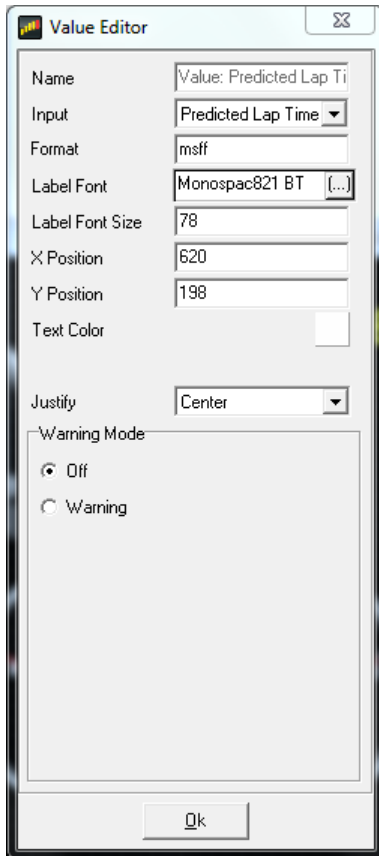

## Value Gauge

The Value Gauge shows the value of the output specified in the **Input** property according to the format specified in the **Format** property. The **Justification** property specifies whether the text is aligned to the left, right or centre of the bounding rectangle.

**Note: It is important to select the background color of the value gauge to be the same as the color of the background the gauge is over. Failure to do so will result in corruption of the value displayed.**

The value gauge has an optional warning mode that changes the color of the gauge when a warning limit for the input is exceeded. To activate warning mode, check the **Warning Mode Active** box and specify the **Warning color**.

- To have the warning activated when the value of the input goes above a certain value, click the **Input Limit Exceed** button and enter a value for the **Warning Limit**. The displayed data will change from the **Text color** to the **Warning color** when the input value is greater than or equal to the **Warning Limit**.
- To have the warning activated based on a secondary input, click the **Secondary Alarm Output** button and select the output to be used as the trigger. The displayed data will change from the **Text color** to the **Warning color** when the secondary input value is non-zero.
- If **Flash If Warning Active** is checked, the gauge will alternate between the warning color and the background color whilst the warning is active.

## Progressive Limit Gauge

The Progressive Limit gauge is typically used to signal an approaching rev limit by means of several boxes that change color as the rev limit approaches. This gauge has the following special properties:

- **Box Count** is the number of boxes in the gauge.
- **Box Size** is the width and height of the box in pixels.
- **Limiter Start** is the value at which the first box will change color from **Background color** to **Fill color**.
- **Limiter Offset** is the value added to the **Limiter Start** to determine when the next box changes color.
- **Draw Circular Limit Lights** - if checked, round LED style boxes will be drawn instead of boxes.

For example, if **Box Count** is 3, **Limiter Start** is 8000 and **Limiter Offset** is 200, the first box will change color at 8000, the second at 8200 and the third at 8400.

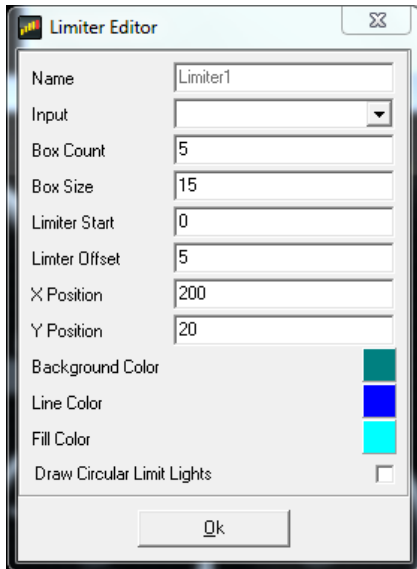

## Bitmap Gauge

The Bitmap gauge is used to show a bitmap from a file or the output of a bitmap selector output. The **Bitmap** property has a drop down box from which any bitmap selector outputs and bitmaps currently present in the setup is selected. At the bottom of the list is the option **Add New Bitmap** which is used to add a new bitmap from a file to the list. Bitmaps must conform to the Microsoft Windows bitmap standard and should be no bigger than 800x480 pixels. The bitmap can be true color (32 bit) though lower definition bitmaps may be preferable to reduce the size of the setup.

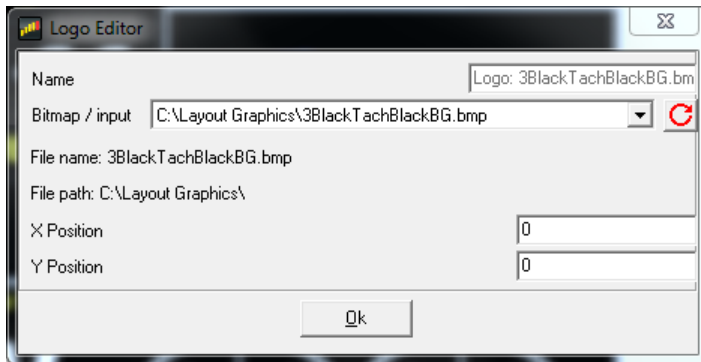

## Alarm Bar Gauge

The Alarm Bar gauge is a block that changes color depending on its input. Typically this is used to indicate out-of-range parameters. For example, an Alarm Bar may be placed next to a gauge showing coolant temperature. The input to the Alarm Bar is configured to give an error signal if the coolant temperature rises above a pre-determined level. The bar color changes from the specified background color to the Fill color to give an easily seen warning indication.

It is also possible to set the warning color of an alarm bar directly from an output. To set this mode, tick the **Drive color Directly From Input** check box. In this mode, the input to the alarm bar is treated as a 16 bit RGB value and this is used to set the color directly. Thus it is possible to have the alarm bar display a range of colors to indicate for example tire or brake temperature.

The 16 RGB color value treats the top 5 bits as red intensity, the next 6 bits as green intensity and the lower 5 bits as blue intensity. Thus, it is possible to display any one of 65535 colors. The hexadecimal (and decimal) values of some common colors are shown below:

- Black 0x0000 (0)
- White 0xFFFF (65535)
- Red 0xF800 (63488)
- Green 0x07E0 (2016)
- Blue 0x001F (31)
- Cyan 0x07FF (2047)
- Yellow 0xFFE0 (65504)

Typically, a function table will be used to map a given value to a specific color. To avoid interpolation between the color values, the function table should be set up such that a range of values defines one color. For example, the following function table would map brake temperatures of 0 to 250 to blue, 251 to 500 to green, 501 to 700 to yellow and 701 to 1000 to red:

Input	Output
0	31
250	31
251	2016
500	2016
501	65504
700	65504
701	63488
1000	63488

Note that it is also possible to display an alarm bar underneath a value gauge. For this to work correctly, the alarm bar must be bigger than the maximum likely size of the value gauge. When setting this up in the editor, it is easier to add the alarm bar to the page first then the value gauge; this ensures that the value gauge is visible and makes sizing the alarm bar correctly easier. If you have trouble selecting an item to edit, you can adjust its Z-Order to push it behind other objects.

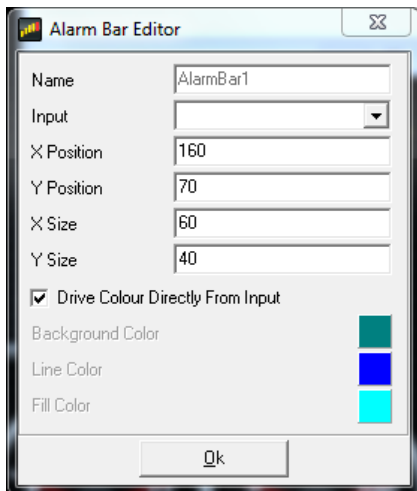

## Shape Gauges

Shape gauges are static gauges (i.e. have no input) that are used to draw shapes on the screen. They have two special properties:

- **Shape** specifies the basic shape as either a Rectangle or an Ellipse.
- **Thickness** specifies the thickness of the border drawn around the shape.

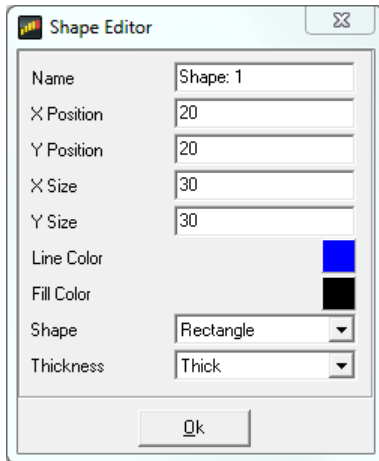

## Cross Hair Gauge

The Cross Hair gauge uses two inputs to move a cross hair around a box. The cross hair gauge has the following special properties:

- **XInput, YInput** specify the inputs for the X and Y axes of the gauge.
- **X Minimum, Y Minimum** specify the starting values for the X and Y axes.
- **X Maximum, Y Maximum** specify the end values for the X and Y axes.
- **Cursor Size** is the size of the cross hair cursor.
- **Background Bitmap** can be used to specify a bitmap that will be shown behind the cross hairs, This can be used to clarify the meaning of a particular position for the cross hair.

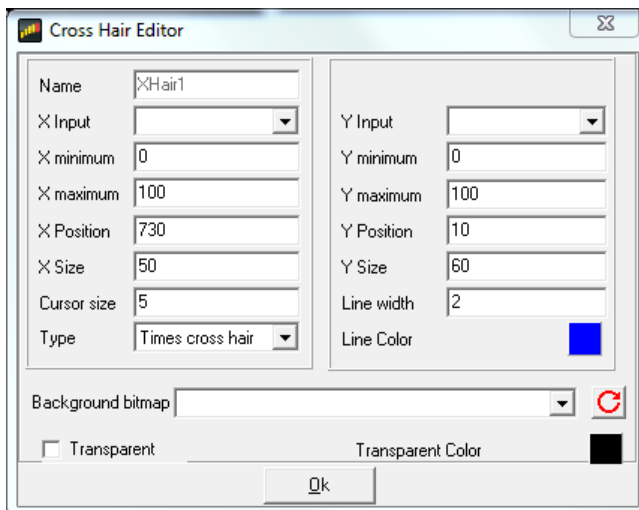

## Historical Graph

The Historical Graph gauge is used to show the trend of one or more outputs in the form of a y-t graph. The Historical Graph gauge has the following special properties:

- **Time Base** - This is the width of the x axis in seconds. When a page with a historical graph gauge is first selected, the data is drawn from the left hand side of the graph (t=0). As the time progresses, the lines progress towards the right hand side of the graph. Once t = time base, the graph scrolls to the left to make more space available for drawing the lines.
- **Input Count** - The number of lines (outputs) drawn in this graph.
- The **Inputs** box allows the details of each line to be specified:
  - **Input Index** - Selects which line the following settings apply to.

- **Input** - The output for which the line is drawn.
- **Line color** - The color of the line.
- **Minimum** - Specifies the lower range of the y axis of the graph for this line. If the value of the output for this line falls below this value, the line will be drawn at the minimum value.
- **Maximum** - Specifies the upper range of the y axis of the graph for this line. If the value of the output for this line exceeds this value, the line will be drawn at the maximum value.
- **Background color** - The background color of the graph.

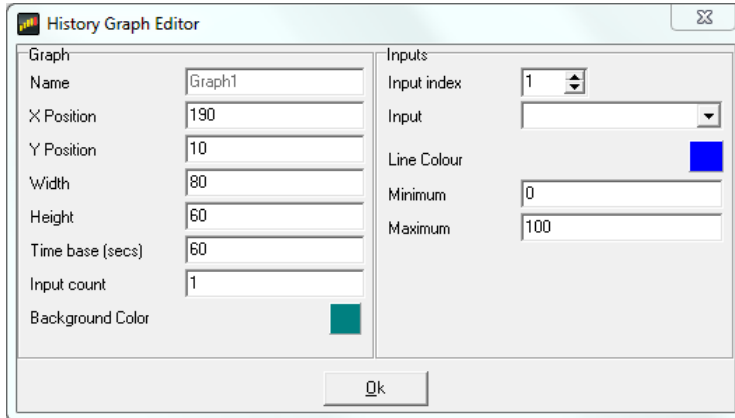

## Round Tacho Bitmap Gauge

The round tacho bitmap gauge allows a scaled pointer or needle to be drawn over a bitmap image of a gauge. This allows much more eye catching graphics to be used for round gauges than could otherwise be drawn dynamically by the display hardware.

The round tacho bitmap gauge has the following special properties:

- **Background bitmap** - the background gauge image.
- **X Centre, Y Centre** - The centre of the gauge from which the logical centre of the pointer will be drawn.
- **Centre Offset** - The number of pixels from the logical pointer centre at which the pointer will be drawn.
- **Length** - The length of the pointer.
- **Start Degrees** - The number of degrees from 6 o'clock (the zero degree position) that the starting value of the gauge should be drawn.
- **End Degrees** - The number of degrees from 6 o'clock (the zero degree position) that the end value of the gauge should be drawn.

The gauge default rotation is clockwise. If you want anti-clockwise operation you switch the Start Val and End Val settings.

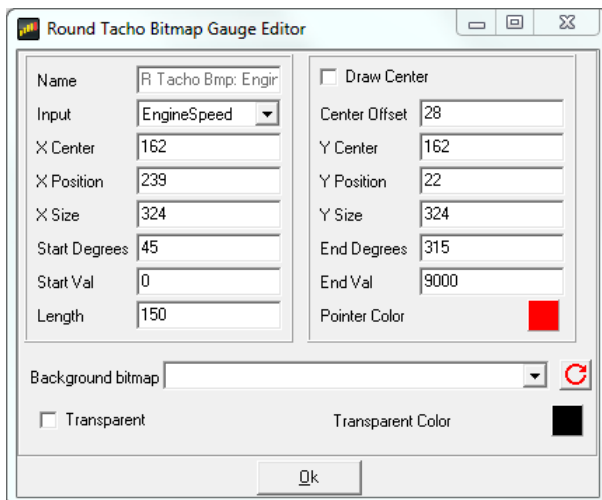

## 12 Month Limited Warranty

Advanced Engine Management Inc. warrants to the consumer that all AEM High Performance products will be free from defects in material and workmanship for a period of twelve (12) months from date of the original purchase. Products that fail within this 12-month warranty period will be repaired or replaced at AEM's option, when determined by AEM that the product failed due to defects in material or workmanship. This warranty is limited to the repair or replacement of the AEM part. In no event shall this warranty exceed the original purchase price of the AEM part nor shall AEM be responsible for special, incidental or consequential damages or cost incurred due to the failure of this product. Warranty claims to AEM must be transportation prepaid and accompanied with dated proof of purchase. This warranty applies only to the original purchaser of product and is non-transferable. All implied warranties shall be limited in duration to the said 12-month warranty period. Improper use or installation, accident, abuse, unauthorized repairs or alterations voids this warranty. AEM disclaims any liability for consequential damages due to breach of any written or implied warranty on all products manufactured by AEM. Warranty returns will only be accepted by AEM when accompanied by a valid Return Merchandise Authorization (RMA) number. Product must be received by AEM within 30 days of the date the RMA is issued.

UEGO oxygen sensors are considered wear items and are not covered under warranty.

Please note that before AEM can issue an RMA for any electronic product, it is first necessary for the installer or end user to contact the EMS tech line at 1-800-423-0046 to discuss the problem. Most issues can be resolved over the phone. Under no circumstances should a system be returned or a RMA requested before the above process transpires.

AEM will not be responsible for electronic products that are installed incorrectly, installed in a non-approved application, misused, or tampered with.

Any AEM electronics product can be returned for repair if it is out of the warranty period. There is a minimum charge of \$50.00 for inspection and diagnosis of AEM electronic parts. Parts used in the repair of AEM electronic components will be extra. AEM will provide an estimate of repairs and receive written or electronic authorization before repairs are made to the product.

# Index

## - A -

Adding gauges 42  
Alarm 31  
Alarm bar gauge 51  
Alarm page 39

## - B -

Bar gauges 45  
Basic setup editing 13  
Bit string 29  
Bitmap 30  
Bitmap gauge 51  
Bitmask 29  
Brightness 40

## - C -

CAN 25  
CAN .dbc 17  
Colors 41  
Copy and Paste 43  
Creating setups 22  
Cross hair gauge 53

## - D -

Default colors 41  
Default setups 11  
Deleting gauges 43  
Display editor 15  
Display screens 40

## - E -

ECU string 29  
Editing gauge properties 43

## - F -

Features 4

Firmware updating 22  
Format 44  
Function table 28

## - G -

Gauge 44, 46  
    adding 42  
    alarm bar 51  
    bar 45  
    bar tacho 46  
    bitmap 51  
    copy and paste 43  
    cross hair 53  
    deleting 43  
    editing properties 43  
    historical graph 53  
    moving 42  
    progressive limit 50  
    resizing 42  
    round tacho 46  
    round tacho bitmap 54  
    selecting 42  
    shape 52  
    standard properties 44  
    text label 47  
    value 49  
    value formatting 44  
    variable string 48  
Gauge properties  
    editing 43  
    standard 44  
GPS 7

## - H -

Historical graph gauge 53

## - I -

Installation 7  
Installing AEM DashDesign 7  
Installing USB Drivers 7  
Introduction 3

---



**- L -**

Lap timing 7, 35  
LEDs 38  
Limit filter 28  
Logging 19

**- M -**

Monitor screen 41  
Mounting 5  
Moving gauges 42

**- O -**

Odometer 34  
On change page 39  
Opening setups 12  
Outputs 24

**- P -**

Programming the display 21  
Progressive limit gauge 50

**- R -**

Rate filter 28  
Resizing gauges 42  
Round tacho bitmap gauge 54

**- S -**

Saving setups 12  
Scalar sensor 27  
Screen  
    adding gauges 42  
    copy and paste 43  
    deleting gauges 43  
    editing gauge properties 43  
    monitor 41  
    moving gauges 42  
    resizing gauges 42  
    selecting gauges 42  
Selecting gauges 42

Sensor  
    scalar 27  
Settings 37  
Setup  
    editor 24  
Setup editor 24  
Setups 11, 12  
    creating 22  
    opening 12  
    saving 12  
    uploading 21  
Shape gauge 52  
Shift lights 38  
Splash screen 41  
Standard gauge properties 44

**- T -**

Tacho gauges 46  
Text label gauge 47  
time filter 28  
Track mapping 35  
Turn Blinkers 34

**- U -**

Updating firmware 22  
Uploading setups 21  
USB drivers  
    Installing 7

**- V -**

Value formatting 44  
Value gauge 49  
Variable string gauge 48

**- W -**

Warning message 33  
Wiring 6

**- Z -**

Z order 44